

# Made to Order Common Specifications:

-XC88: Spatter Resistant Coil Scraper, Lube-retainer, Grease for Welding (Piston rod: Stainless steel 304)

-XC89: Spatter Resistant Coil Scraper, Lube-retainer, Grease for Welding (Piston rod: S45C)

-XC91: Spatter Resistant Coil Scraper, Grease for Welding (Piston rod: S45C)



**62** Spatter Resistant Coil Scraper, Lube-retainer, Grease for Welding (Piston rod: Stainless steel 304) **-XC88**

**63** Spatter Resistant Coil Scraper, Lube-retainer, Grease for Welding (Piston rod: S45C) **-XC89**

Reduces spatter adhesion and improves durability by the use of the coil scraper, Lube-retainer and grease for welding.

**64** Spatter Resistant Coil Scraper, Grease for Welding (Piston rod: S45C) **-XC91**

With coil scraper and grease for welding

## Applicable Series

Series	Description	Model	Action	XC88	XC89	XC91	Note	Vol. no. (for std model)
MB	Air cylinder	MB-Z	Double acting, Single rod	●	●	●	ø32-ø100 only	Web Catalog
CA2	Air cylinder	CA2-Z	Double acting, Single rod	●	●	●		
CQ2	Compact cylinder	CQ2-Z	Double acting, Single rod	●	●	●		
	Long stroke	CQ2-Z	Double acting, Single rod	●	●	—		
	Anti-lateral load	CQ2□S-Z	Double acting, Single rod	●	●	—		
MGP	Compact guide cylinder	MGPM-Z	Double acting	●	—*	●	ø32-ø100 only	
		MGPL-Z	Double acting	—	—	●		
		MGPA-Z	Double acting	—	—	●		
MK2T	Rotary clamp cylinder	MK2T	Double acting	—	●	●	ø32-ø63 only	
CKG1	Clamp cylinder	CKG1-Z	Double acting, Single rod	●	●	●		
	Clamp cylinder	CKGA	Double acting, Single rod	●	●	●	ø80 and ø100 only	

## Common Specifications: MB, CA2, CQ2, MK2T, CKG1

Part no.	Piston rod material (Hard chrome plating)		Coil scraper	Lube-retainer	Grease for welding
	S45C	Stainless steel 304			
-XC88	—	●	●	●	●
-XC89	●	—	●	●	●
-XC91	●	—	●	—	●

Note) Use the -XC91 in a place where the distance from the welding portion is far and the spatter scattering is minimized.

## Specifications: MGP

Part no.	Piston rod/Guide rod material (Hard chrome plating)		Coil scraper		Lube-retainer		Grease for welding
	S45C	Stainless steel 304	Rod side	Head side	Rod side	Head side	
-XC88	—	●	●	—	●	—	●
-XC91	●	—	●	—	●	—	●
-XC88W	—	●	●	●	●	●	●
-XC89W	●	—	●	●	●	●	●
-XC91W	●	—	●	●	●	—	●

\* There is no "-XC89" part number suffix as the specifications are the same as those of the "-XC91."

# Made to Order Common Specifications:

-XC88: Spatter Resistant Coil Scraper, Lube-retainer, Grease for Welding (Piston rod: Stainless steel 304)

-XC89: Spatter Resistant Coil Scraper, Lube-retainer, Grease for Welding (Piston rod: S45C)

-XC91: Spatter Resistant Coil Scraper, Grease for Welding (Piston rod: S45C)



## MB-XC88/XC89/XC91

**62** Spatter Resistant Coil Scraper, Lube-retainer, Grease for Welding (Piston rod: Stainless steel 304) **-XC88**

**63** Spatter Resistant Coil Scraper, Lube-retainer, Grease for Welding (Piston rod: S45C) **-XC89**

Reduces spatter adhesion and improves durability by the use of the coil scraper, Lube-retainer and grease for welding.

**64** Spatter Resistant Coil Scraper, Grease for Welding (Piston rod: S45C) **-XC91**

With coil scraper and grease for welding

### Applicable Series

Series	Description	Model	Action	XC88	XC89	XC91	Vol. no. (for std. model)
MB	Air cylinder	MB-Z	Double acting, Single rod	●	●	●	Web Catalog

### How to Order

Standard model no. — XC89

Spatter-resistant rod material

XC88	Stainless steel 304
XC89	S45C
XC91	S45C

### Made to Order

Part no.	Piston rod material (Hard chrome plated)		Coil scraper	Lube-retainer	Grease for welding
	S45C	Stainless steel 304			
-XC88	—	●	●	●	●
-XC89	●	—	●	●	●
-XC91	●	—	●	—	●

Note) Use the -XC91 in a place where the distance from the welding portion is far and the spatter scattering is minimized.

### Specifications

Bore size	ø32, ø40, ø50, ø63, ø80, ø100
Port thread type	Rc
Max. manufacturable stroke	See right side.
Rod boot	None
Cushion	Air cushion
Dimensions	See below.
Additional specifications	Same as standard type

### Max. manufacturable stroke

Bore size (mm)	Max. manufacturable stroke
32	1000
40	1000
50	1000
63	1000
80	1000
100	1000

Manufacture of intermediate strokes is possible. (Spacers are not used.)  
Produced upon receipt of order.

### Dimensions (Other dimensions are the same as the standard type.)

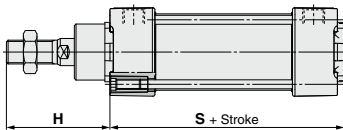

Bore size (mm)	XC88, 89		XC91		XC35	
	H	S	H	S	H	S
32	50	88	47	88	47	88
40	61	88	58	88	58	88
50	67	98	67	98	67	98
63	67	98	67	98	67	98
80	82	118	81	118	81	118
100	82	118	81	118	81	118

\* At 0 stroke

# Made to Order Common Specifications:

- XC88: Spatter Resistant Coil Scraper, Lube-retainer, Grease for Welding (Piston rod: Stainless steel 304)
- XC89: Spatter Resistant Coil Scraper, Lube-retainer, Grease for Welding (Piston rod: S45C)
- XC91: Spatter Resistant Coil Scraper, Grease for Welding (Piston rod: S45C)



## CA2-XC88/XC89/XC91

**62** Spatter Resistant Coil Scraper, Lube-retainer, Grease for Welding (Piston rod: Stainless steel 304) **-XC88**

**63** Spatter Resistant Coil Scraper, Lube-retainer, Grease for Welding (Piston rod: S45C) **-XC89**

Reduces spatter adhesion and improves durability by the use of the coil scraper, Lube-retainer and grease for welding.

**64** Spatter Resistant Coil Scraper, Grease for Welding (Piston rod: S45C) **-XC91**

With coil scraper and grease for welding

### Applicable Series

Series	Description	Model	Action	XC88	XC89	XC91	Vol. no. (for std model)
CA2	Air cylinder	CA2-Z	Double acting, Single rod	●	●	●	Web Catalog

### How to Order

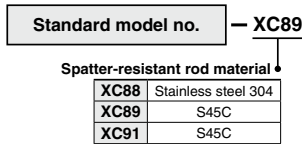

### Made to Order

Part no.	Piston rod material (Hard chrome plated)		Coil scraper	Lube-retainer	Grease for welding
	S45C	Stainless steel 304			
-XC88	—	●	●	●	●
-XC89	●	—	●	●	●
-XC91	●	—	●	—	●

Note) Use the -XC91 in a place where the distance from the welding portion is far and the spatter scattering is minimized.

### Specifications

Bore size	ø40, ø50, ø63, ø80, ø100
Tubing material	Aluminum tube
Port thread type	Rc
Max. manufacturable stroke	See right side.
Rod boot	None
Cushion	Air cushion
Dimensions	See below.
Additional specifications	Same as standard type

### Max. manufacturable stroke

(mm)

Bore size	Max. manufacturable stroke <sup>Note 1)</sup>
40	1000
50, 63	1000
80, 100	1000

Note 1) For details about applicable maximum stroke, refer to the model selection table on the Web Catalog.

### Dimensions (Other dimensions are the same as the standard type.)

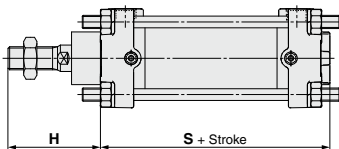

Bore size (mm)	XC88, 89		XC91		XC35	
	H	S	H	S	H	S
40	56	95	51	95	51	95
50	60	101	58	101	58	101
63	60	112	58	112	58	112
80	73	133	71	133	71	133
100	74	143	72	143	72	143

\* At 0 stroke

# Made to Order Common Specifications:

-XC88: Spatter Resistant Coil Scraper, Lube-retainer, Grease for Welding (Piston rod: Stainless steel 304)

-XC89: Spatter Resistant Coil Scraper, Lube-retainer, Grease for Welding (Piston rod: S45C)

-XC91: Spatter Resistant Coil Scraper, Grease for Welding (Piston rod: S45C)



## CQ2-XC88/XC89/XC91

**62** Spatter Resistant Coil Scraper, Lube-retainer, Grease for Welding (Piston rod: Stainless steel 304) **-XC88**

**63** Spatter Resistant Coil Scraper, Lube-retainer, Grease for Welding (Piston rod: S45C) **-XC89**

Reduces spatter adhesion and improves durability by the use of the coil scraper, Lube-retainer and grease for welding.

**64** Spatter Resistant Coil Scraper, Grease for Welding (Piston rod: S45C) **-XC91**

With coil scraper and grease for welding

■ CDQ2 series (Standard)

■ CDQ2 series (Long Stroke)

■ CDQ2□S series (Anti-lateral Load)

### Applicable Series

Series	Description	Model	Action	Note	XC88	XC89	XC91
CQ2	Compact cylinder	CQ2-Z	Double acting, Single rod	With auto switch magnet only	●	●	●
	Long stroke	CQ2-Z	Double acting, Single rod		●	●	—
	Anti-lateral load	CQ2□S-Z	Double acting, Single rod		●	●	—

### Made to Order

Part no.	Piston rod material (Hard chrome plated)		Coil scraper	Lube-retainer	Grease for welding
	S45C	Stainless steel 304			
-XC88	—	●	●	●	●
-XC89	●	—	●	●	●
-XC91	●	—	●	—	●

Note) Use the -XC91 in a place where the distance from the welding portion is far and the spatter scattering is minimized.

### How to Order

CDQ2 **Standard model no.** — **XC89**

Spatter-resistant rod material ↓

<b>XC88</b>	Stainless steel 304
<b>XC89</b>	S45C
<b>XC91</b>	S45C

(Standard)

### Specifications

<b>Bore size</b>	φ32, φ40, φ50, φ63, φ80, φ100
<b>Mounting brackets</b>	Excludes the compact foot bracket
<b>Type</b>	Pneumatic
<b>Mounting bolt for the through-hole type</b>	Not included
<b>Dimensions</b>	See below.
<b>Additional specifications</b>	Same as standard type

(Long stroke)

### Specifications

<b>Mounting brackets</b>	Excludes the compact foot bracket
<b>Type</b>	Pneumatic
<b>Cushion</b>	Rubber bumper
<b>Dimensions</b>	See below.
<b>Additional specifications</b>	Same as standard type

(Anti-lateral load)

### Specifications

<b>Mounting brackets</b>	Excludes the compact foot bracket
<b>Dimensions</b>	See below.
<b>Additional specifications</b>	Same as standard type

### Dimensions (Other dimensions are the same as the standard type.)

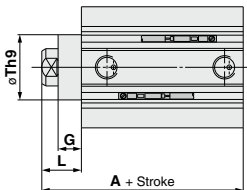

Bore size (mm)	XC88, 89						XC91				(mm)
	A			G	L	Th9	A	G	L	Th9	
	Standard	Long stroke	Anti-lateral load								
<b>32</b>	50	67.5	60	10	17	23 <sup>0</sup> <sub>-0.0102</sub>	45	5	12	23 <sup>0</sup> <sub>-0.0102</sub>	
<b>40</b>	56.5	77	66.5	10	17	28 <sup>0</sup> <sub>-0.0102</sub>	51.5	5	12	28 <sup>0</sup> <sub>-0.0102</sub>	
<b>50</b>	58.5	78.5	68.5	10	18	35 <sup>0</sup> <sub>-0.0102</sub>	53.5	5	13	35 <sup>0</sup> <sub>-0.0102</sub>	
<b>63</b>	64	80	74	10	18	35 <sup>0</sup> <sub>-0.0102</sub>	59	5	13	35 <sup>0</sup> <sub>-0.0102</sub>	
<b>80</b>	73.5	91	83.5	10	20	43 <sup>0</sup> <sub>-0.0102</sub>	68.5	5	15	43 <sup>0</sup> <sub>-0.0102</sub>	
<b>100</b>	85	102.5	95	10	22	59 <sup>0</sup> <sub>-0.0174</sub>	80	5	17	59 <sup>0</sup> <sub>-0.0174</sub>	

# Made to Order Common Specifications:

-XC88: Spatter Resistant Coil Scraper, Lube-retainer, Grease for Welding (Piston rod: Stainless steel 304)

-XC89: Spatter Resistant Coil Scraper, Lube-retainer, Grease for Welding (Piston rod: S45C)

-XC91: Spatter Resistant Coil Scraper, Grease for Welding (Piston rod: S45C)



## MGP-XC88(W)/XC89W/XC91(W)

**62** Spatter Resistant Coil Scraper, Lube-retainer, Grease for Welding (Piston rod: Stainless steel 304) **-XC88**

**63** Spatter Resistant Coil Scraper, Lube-retainer, Grease for Welding (Piston rod: S45C) **-XC89**

Reduces spatter adhesion and improves durability by the use of the coil scraper, Lube-retainer and grease for welding.

**64** Spatter Resistant Coil Scraper, Grease for Welding (Piston rod: S45C) **-XC91**

With coil scraper and grease for welding

### Applicable Series

Series	Description	Model	Action	XC88(W)	XC89	XC91(W)	Note	Vol. no. (for std model)
MGP	Compact guide cylinder	MGPM-Z	Double acting	●	—*	●	ø32 to ø100 only	Web Catalog
		MGPL-Z		—	—	●		
		MGPA-Z		—	—	●		

### Made to Order

Part no.	Piston rod/ Guide rod material (Hard chrome plating)		Coil scraper		Lube-retainer		Grease for welding
	S45C	Stainless steel 304	Rod side	Head side	Rod side	Head side	
-XC88	—	●	●	—	●	—	●
-XC91	●	—	●	—	●	—	●
-XC88W	—	●	●	●	●	●	●
-XC89W	●	—	●	●	●	●	●
-XC91W	●	—	●	●	●	—	●

\* There is no "-XC89" part number suffix as the specifications are the same as those of the "-XC91."

### Specifications

<b>Bore size</b>	XC88, XC91	ø32, ø40, ø50, ø63, ø80, ø100
<b>Max. operating pressure</b>	XC88W, XC89W, XC91W	0.12 MPa 0.14 MPa
<b>Dimensions</b>	See below.	
<b>Additional specifications</b>	Same as standard type	

### How to Order

Standard model no. — XC88W		
Spatter-resistant rod material		
Symbol	Scraper mounting position	Rod material
XC88	Single side scraper	Stainless steel 304
XC91		S45C
XC88W	Both sides scraper	Stainless steel 304
XC89W		S45C
XC91W		S45C

### Single side scraper

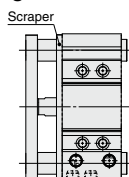

### Both sides scraper

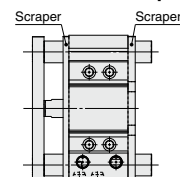

### Dimensions (Other dimensions are the same as the standard type.)

#### Single side scraper (-XC88, -XC91)

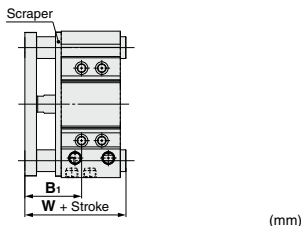

Bore size (mm)	XC88		XC91		XC35	
	B <sub>1</sub>	W <sup>Note 1)</sup>	B <sub>1</sub>	W <sup>Note 1)</sup>	B <sub>1</sub>	W <sup>Note 1)</sup>
32	53	85	53	85	53	85
40	54	85	54	85	54	85
50	62	98.5	62	98.5	62	98.5
63	62	98.5	62	98.5	62	98.5
80	78	114.5	78	114.5	78	114.5
100	71	136.5	71	136.5	71	136.5

\* At 0 stroke

Note 1) W dimensions are for 50 stroke or less.

#### Both sides scraper (-XC88W, -XC89W, -XC91W)

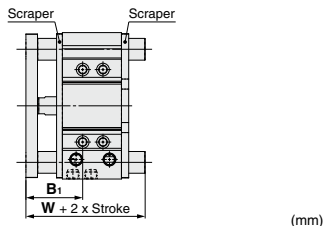

Bore size (mm)	XC88W XC89W		XC91W		XC35W	
	B <sub>1</sub>	W	B <sub>1</sub>	W	B <sub>1</sub>	W
32	53	82.5	53	82.5	53	82.5
40	54	89.5	54	89	54	89
50	62	95	62	95	62	95
63	62	100	62	100	62	100
80	78	120.5	78	120.5	78	120.5
100	71	143	71	143	71	143

\* At 0 stroke

# Made to Order Common Specifications:

-XC88: Spatter Resistant Coil Scraper, Lube-retainer, Grease for Welding (Piston rod: Stainless steel 304)

-XC89: Spatter Resistant Coil Scraper, Lube-retainer, Grease for Welding (Piston rod: S45C)

-XC91: Spatter Resistant Coil Scraper, Grease for Welding (Piston rod: S45C)



## MK2T-XC89/XC91

**63 Spatter Resistant Coil Scraper, Lube-retainer, Grease for Welding (Piston rod: S45C) -XC89**

Reduces spatter adhesion and improves durability by the use of the coil scraper, Lube-retainer and grease for welding.

**64 Spatter Resistant Coil Scraper, Grease for Welding (Piston rod: S45C) -XC91**

With coil scraper and grease for welding

### Applicable Series

Series	Description	Model	Action	XC89	XC91	Vol. no. (for std model)
MK2T	Rotary clamp cylinder	MK2T	Double acting	●	●	Web Catalog

### How to Order

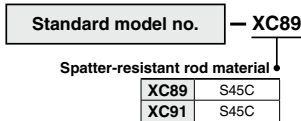

### Made to Order

Part no.	Piston rod material (Hard chrome plated)	Coil scraper	Lube-retainer	Grease for welding
	S45C			
-XC89	●	●	●	●
-XC91	●	●	—	●

Note) Use the -XC91 in a place where the distance from the welding portion is far and the spatter scattering is minimized.

### Specifications

Bore size	ø32, ø40, ø50, ø63
Dimensions	See below.
Additional specifications	Same as standard type

### Dimensions (Other dimensions are the same as the standard type.)

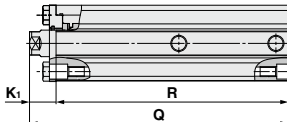

#### Clamp stroke: 10 mm (mm)

Bore size	XC89			XC91		
	Q	R	K <sub>1</sub>	Q	R	K <sub>1</sub>
32	156	140	16	148	140	8
40	160.5	144	16.5	151.5	144	7.5
50	—	—	—	—	—	—
63	—	—	—	—	—	—

#### Clamp stroke: 20 mm (mm)

Bore size	XC89			XC91		
	Q	R	K <sub>1</sub>	Q	R	K <sub>1</sub>
32	176	160	16	168	160	8
40	180.5	164	16.5	171.5	164	7.5
50	202.5	179	23.5	191	179	12
63	205	182	23	192	182	10

#### Clamp stroke: 50 mm (mm)

Bore size	XC89			XC91		
	Q	R	K <sub>1</sub>	Q	R	K <sub>1</sub>
32	—	—	—	—	—	—
40	—	—	—	—	—	—
50	266	242.5	23.5	254.5	242.5	12
63	269	246	23	256	246	10

# Made to Order Common Specifications:

-XC88: Spatter Resistant Coil Scraper, Lube-retainer, Grease for Welding (Piston rod: Stainless steel 304)

-XC89: Spatter Resistant Coil Scraper, Lube-retainer, Grease for Welding (Piston rod: S45C)

-XC91: Spatter Resistant Coil Scraper, Grease for Welding (Piston rod: S45C)



## CKG1-XC88/XC89/XC91

**62** Spatter Resistant Coil Scraper, Lube-retainer, Grease for Welding (Piston rod: Stainless steel 304) **-XC88**

**63** Spatter Resistant Coil Scraper, Lube-retainer, Grease for Welding (Piston rod: S45C) **-XC89**

Reduces spatter adhesion and improves durability by the use of the coil scraper, Lube-retainer and grease for welding.

**64** Spatter Resistant Coil Scraper, Grease for Welding (Piston rod: S45C) **-XC91**

With coil scraper and grease for welding

■ **CKG1 series** **Magnetic Field Resistant Auto Switch Rod Mounting Type**

■ **CKG1 series** **General Purpose Auto Switch Band Mounting/Rod Mounting**

### Applicable Series

Series	Description	Model	Action	XC88	XC89	XC91	Vol. no. (for std model)
CKG1	Clamp cylinder	CKG1-Z1	Double acting, Single rod	●	●	●	Web Catalog
		CKG1-Z	Double acting, Single rod	●	●	●	

### How to Order

Standard model no. — **XC89**

Spatter-resistant rod material ↓

<b>XC88</b>	Stainless steel 304
<b>XC89</b>	S45C
<b>XC91</b>	S45C

Cushion ↓

<b>NIII</b>	With air cushion on the unclamped side (head end) (Standard)
<b>W</b>	With air cushion on both ends

Note) The dimensions of the product with the air cushion on both ends are the same as those of the product with the air cushion on the unclamped side (head end).

### Specifications/CKG1-Z, CKG1-Z1 common

<b>Bore size</b>	ø40, ø50, ø63
<b>End bracket</b>	I, IA, Y, YA
<b>Option</b>	Mounting brackets "B," "D," "L," and "K" are not available.
<b>Dimensions</b>	See below.
<b>Additional specifications</b>	Same as standard type

### Dimensions/CKG1-Z, CKG1-Z1 common (Other dimensions are the same as the standard type.)

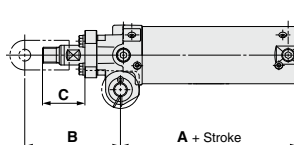

Bore size (mm)	XC88, 89			XC91		
	A	B	C	A	B	C
<b>40</b>	78	97	43	78	97	52
<b>50</b>	78	97	43	78	97	52
<b>63</b>	78	97	43	78	97	52

\* At 0 stroke

# Made to Order Common Specifications:

-XC88: Spatter Resistant Coil Scraper, Lube-retainer, Grease for Welding (Piston rod: Stainless steel 304)

-XC89: Spatter Resistant Coil Scraper, Lube-retainer, Grease for Welding (Piston rod: S45C)

-XC91: Spatter Resistant Coil Scraper, Grease for Welding (Piston rod: S45C)



## CKGA-XC88/XC89/XC91

**62** Spatter Resistant Coil Scraper, Lube-retainer, Grease for Welding (Piston rod: Stainless steel 304) **-XC88**

**63** Spatter Resistant Coil Scraper, Lube-retainer, Grease for Welding (Piston rod: S45C) **-XC89**

Reduces spatter adhesion and improves durability by the use of the coil scraper, Lube-retainer and grease for welding.

**64** Spatter Resistant Coil Scraper, Grease for Welding (Piston rod: S45C) **-XC91**

With coil scraper and grease for welding

### CKGA series Rod Mounting

### Applicable Series

Series	Description	Model	Action	XC88	XC89	XC91	Vol. no. (for std model)
CKG1	Clamp cylinder	CKGA	Double acting, Single rod	●	●	●	Web Catalog

### How to Order

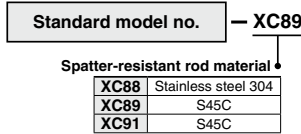

### Made to Order

Part no.	Piston rod material (Hard chrome plated)		Coil scraper	Lube-retainer	Grease for welding
	S45C	Stainless steel 304			
-XC88	—	●	●	●	●
-XC89	●	—	●	●	●
-XC91	●	—	●	—	●

Note) Use the -XC91 in a place where the distance from the welding portion is far and the spatter scattering is minimized.

### Specifications

<b>Bore size</b>	ø80, ø100
<b>Dimensions</b>	Same as standard type
<b>Additional specifications</b>	Same as standard type



## Made to Order Common Specifications:

-XC88: Spatter Resistant Coil Scraper, Lube-retainer, Grease for Welding (Piston rod: Stainless steel 304)

-XC89: Spatter Resistant Coil Scraper, Lube-retainer, Grease for Welding (Piston rod: S45C)

-XC91: Spatter Resistant Coil Scraper, Grease for Welding (Piston rod: S45C)



# CKGA-XC88/XC89/XC91

**62** Spatter Resistant Coil Scraper, Lube-retainer, Grease for Welding (Piston rod: Stainless steel 304) **-XC88**

**63** Spatter Resistant Coil Scraper, Lube-retainer, Grease for Welding (Piston rod: S45C) **-XC89**

Reduces spatter adhesion and improves durability by the use of the coil scraper, Lube-retainer and grease for welding.

**64** Spatter Resistant Coil Scraper, Grease for Welding (Piston rod: S45C) **-XC91**

With coil scraper and grease for welding

Bore Size

## Ø80 to Ø100

**CKGA100**<sup>-XC88/XC89</sup><sub>-XC91</sub> With auto switch (D-P4DWS□).

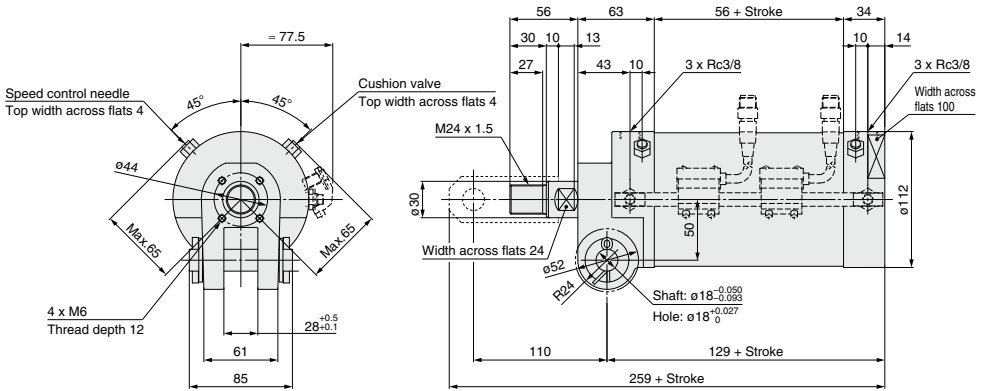

**CKGA80**<sup>-XC88/XC89</sup><sub>-XC91</sub> With auto switch (D-P4DWS□).

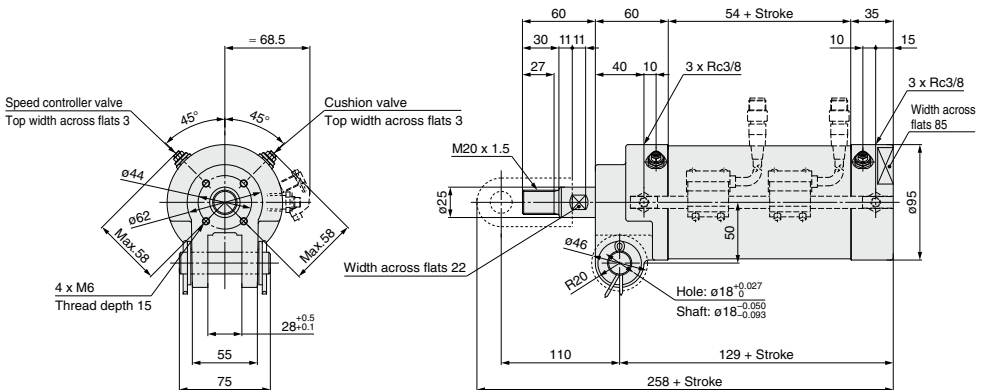

The specifications of the end bracket (double knuckle joint with pins) are the same as those of the standard model.

### Comparison of the Dimensions of Each Series

The -XC88/XC89/XC91 and standard product have the same dimensions.