

# Series 10-SV1000/2000/3000/4000

5 Port Solenoid Valve

## Serial wiring

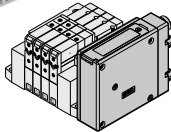
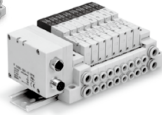
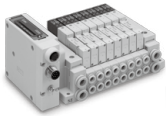

### Decentralized serial wiring

P.182

IP67 compliant

Applicable series	Cassette base manifold
	<b>10-SV1000/10-SV2000</b>
Applicable series	Tie-rod base manifold
	<b>10-SV1000/10-SV2000/10-SV3000/10-SV4000</b>
<ul style="list-style-type: none"> <li>· Number of outputs: 32/16</li> <li>· EX500 gateway communication specifications</li> </ul>	

### Serial wiring with input/output unit

P.192

IP67 compliant

Applicable series	Tie-rod base manifold
	<b>10-SV1000/10-SV2000/10-SV3000</b>
<ul style="list-style-type: none"> <li>· Number of inputs/outputs: 32 each</li> </ul>	

IP67 compliant

Applicable series	Tie-rod base manifold
	<b>10-SV1000/10-SV2000/10-SV3000</b>
<ul style="list-style-type: none"> <li>· Digital inputs/outputs: Max. 144/144</li> <li>· Analog input: Max. 18 channels</li> <li>· Number of valve outputs: 32</li> </ul>	

### Dedicated output serial wiring

P.208

IP67 compliant  
(Some products are IP40)

Applicable series	Cassette base manifold
	<b>10-SV1000/10-SV2000</b>
Applicable series	Tie-rod base manifold
	<b>10-SV1000/10-SV2000/10-SV3000/10-SV4000</b>
<ul style="list-style-type: none"> <li>· Number of outputs: 16</li> </ul>	
Applicable series	Tie-rod base manifold
	<b>10-SV1000/10-SV2000/10-SV3000</b>
<ul style="list-style-type: none"> <li>· Number of outputs: 32/16</li> </ul>	

## Parallel wiring

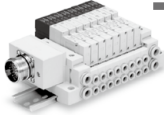

### For circular connector

P.230

IP67 compliant

Applicable series	Cassette base manifold
	<b>10-SV1000/10-SV2000</b>
Applicable series	Tie-rod base manifold
	<b>10-SV1000/10-SV2000/10-SV3000/10-SV4000</b>
<ul style="list-style-type: none"> <li>· Number of connectors: 26 pins</li> </ul>	

### D-sub connector

P.240

Applicable series	Cassette base manifold
	<b>10-SV1000/10-SV2000</b>
Applicable series	Tie-rod base manifold
	<b>10-SV1000/10-SV2000/10-SV3000/10-SV4000</b>
<ul style="list-style-type: none"> <li>· Number of connectors: 25 pins</li> <li>· MIL-C-24308</li> <li>· Conforming to JIS-X-5101</li> </ul>	

### Flat ribbon cable connector

P.250

Applicable series	Cassette base manifold
	<b>10-SV1000/10-SV2000</b>
Applicable series	Tie-rod base manifold
	<b>10-SV1000/10-SV2000/10-SV3000/10-SV4000</b>
<ul style="list-style-type: none"> <li>· Number of connectors: 26, 20, 10 pins</li> <li>· With strain relief</li> <li>· Conforming to MIL-C-83503</li> </ul>	

### Valve manifold specifications

P.260

Manifold option

### Single unit/Sub-plate [IP67 compliant]

P.265

IP67 compliant	Applicable series	<b>10-SV1000/10-SV2000/10-SV3000/10-SV4000</b>
		<ul style="list-style-type: none"> <li>· With waterproof M12 connector</li> </ul>

# Valve Manifold Common Specifications

## Cassette base manifold

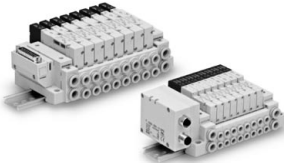

### Manifold Specifications

Applicable series		10-SV1000	10-SV2000
<b>Manifold type</b>		Stacking type cassette base manifold	
<b>1 (P: SUP), 3/5 (E: EXH) type</b>		Common SUP, EXH	
<b>Valve stations (maximum)</b>		18 stations	20 stations
<b>Max. number of solenoids</b>		18 points	26 points
<b>Port size</b>	<b>1(P), 3/5(E) port</b>	C8, N9	C10, N11
	<b>4(A), 2(B) port</b>	C3, C4, C6 N1, N3, N7	C4, C6, C8 N3, N7, N9

### Flow Rate Characteristics

Model	Port size		Flow rate characteristics					
	1, 5, 3 (P, EA, EB)	4, 2 (A, B)	1→4/2 (P→A/B)			4/2→3/5 (A/B→E)		
			C [dm <sup>3</sup> /(s·bar)]	b	Cv	C [dm <sup>3</sup> /(s·bar)]	b	Cv
10-SS5V1-16	C8	C6	0.89	0.22	0.22	0.98	0.21	0.23
10-SS5V2-16	C10	C8	2.3	0.28	0.50	2.7	0.18	0.56

Note) The values are for individually operated 2 position type manifold bases with 5 stations.

## Tie-rod base manifold



### Manifold Specifications

Applicable series		10-SV1000	10-SV2000	10-SV3000	10-SV4000
<b>Manifold type</b>		Tie-rod base manifold			
<b>1 (P: SUP), 3/5 (E: EXH) type</b>		Common SUP, EXH			
<b>Valve stations (maximum)</b>		20 stations			
<b>Max. number of solenoids</b>		32 points			
<b>Port size</b>	<b>1(P), 3/5(E) port</b>	C8, N9	C10, N11	C12, N11	C12, N11, 03
	<b>4(A), 2(B) port</b>	C3, C4, C6 N1, N3, N7	C4, C6, C8 N3, N7, N9	C6, C8, C10 N7, N9, N11	C8, C10, C12 N9, N11, 02, 03

### Flow Rate Characteristics

Model	Port size		Flow rate characteristics					
	1, 5, 3 (P, EA, EB)	4, 2 (A, B)	1→4/2 (P→A/B)			4/2→3/5 (A/B→E)		
			C [dm <sup>3</sup> /(s·bar)]	b	Cv	C [dm <sup>3</sup> /(s·bar)]	b	Cv
10-SS5V1-10	C8	C6	0.98	0.26	0.24	1.1	0.35	0.28
10-SS5V2-10	C10	C8	2.1	0.20	0.46	2.4	0.18	0.48
10-SS5V3-10	C12	C10	4.2	0.22	0.91	4.3	0.21	0.93
10-SS5V4-10	C12	C12	6.2	0.19	1.3	7.0	0.18	1.6

Note) The values are for individually operated 2 position type manifold bases with 5 stations.

### Enclosure of Manifold Variations (Common for cassette base and tie-rod base)

Series	Enclosure (Based on IEC529)
EX500 Decentralized serial wiring	IP67 *1
EX250 Serial wiring with input/output unit	IP67
EX600 Serial wiring with input/output unit	IP67 (Manifold assembly)
EX120 Dedicated output serial wiring	Dusttight (IP40)
EX260 Dedicated output serial wiring	IP67 *2
For circular connector	IP67
D-sub connector	Dusttight (IP40)
Flat ribbon cable	Dusttight (IP40)

\*1 Enclosure of a gateway unit and input manifold is IP65.

\*2 Enclosure is IP40 when the communication connector is D-sub.

Directional Control Valves

Air Cylinders

Rotary Actuators

Air Grippers

Air Preparation Equipment

Modular F. R.

Pressure Control Equipment

Fittings & Tubing

Flow Control Equipment

Pressure Switches/ Pressure Sensors

**Series 10-SV Solenoid Valve Specifications**



**Made to Order**  
(For details, refer to page 272.)

**Symbol**

**Series 10-SV1000/2000/3000/4000**

**2 position single**

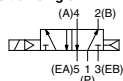

**2 position double**

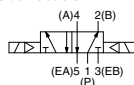

**Series 10-SV1000/2000/3000**

**3 position closed center**

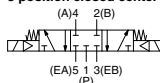

**3 position exhaust center**



**3 position pressure center**

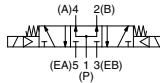

**Series 10-SV4000**

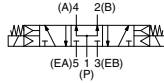
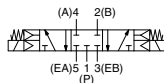

**Series 10-SV1000**

**4 position dual 3 port valve**

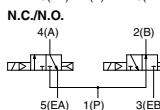
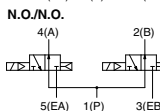
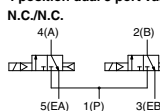

**Series 10-SV2000**

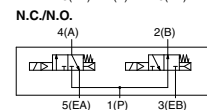
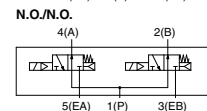
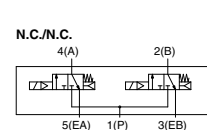

\* SV3000 and 4000 are not available with 4 position dual 3 port valve.

Fluid	Air	
Internal pilot operating pressure range (MPa)	2 position single	0.15 to 0.7
	4 position dual 3 port valve	
	2 position double	
External pilot operating pressure range (MPa)	3 position	0.1 to 0.7
	Operating pressure range	
	2 position single, double	
Ambient and fluid temperature (°C)	3 position	-100 kPa to 0.7
		0.25 to 0.7
Max. operating frequency (Hz)	2 position single, double	-10 to 50 (No freezing. Refer to page 680.)
Manual override	4 position dual 3 port valve	
	3 position	
Pilot exhaust method	Non-locking push type	Main/Pilot valve common exhaust
	Push-turn locking slotted type	
Lubrication	Internal pilot	Pilot valve individual exhaust
Mounting orientation	External pilot	
Impact/Vibration resistance (m/s <sup>2</sup> )		Not required
Enclosure		Unrestricted
Coil rated voltage		150/30
Allowable voltage fluctuation		IP67 (Based on IEC60529)
Power consumption		24 VDC, 12 VDC
Surge voltage suppressor		±10% of rated voltage
Indicator light		0.6 (With indicator light: 0.65)
		Zener diode
		LED

Note) Impact resistance: No malfunction occurred when it was tested in the axial direction and at right angles to the main valve and armature in both energized and de-energized states once for each condition. (Default settings)

Vibration resistance: No malfunction occurred in a one-sweep test between 45 and 2000 Hz. Test was performed in both energized and de-energized states in the axial direction and at right angles to the main valve and armature. (Default settings)

**Response Time**

Actuation type	Response time (ms) (at the pressure of 0.5 MPa)			
	10-SV1000	10-SV2000	10-SV3000	10-SV4000
2 position single	11 or less	25 or less	28 or less	40 or less
2 position double	10 or less	17 or less	26 or less	40 or less
3 position	18 or less	29 or less	32 or less	82 or less
4 position dual 3 port valve	15 or less	33 or less	—	—

Note) Based on dynamic performance test, JIS B 8375-1981 (Coil temperature: 20°C, at rated voltage)

**Weight**

Series	Actuation type	Weight (g)
10-SV1000	Single solenoid	66
	Double solenoid	71
	3 position	73
	4 position dual 3 port	71
10-SV2000	Single solenoid	74
	Double solenoid	78
	3 position	83
	4 position dual 3 port	78
10-SV3000	Single solenoid	99
	Double solenoid	102
	3 position	110
10-SV4000	Single solenoid	186
	Double solenoid	190
	3 position	211

Note) Weight of solenoid valve only.

# Decentralized Serial Wiring

## EX500 Series

IP67 compliant

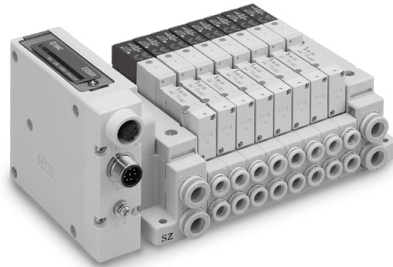

### EX500 Gateway Decentralized System 2 **P.182**

Applicable series	Tie-rod base manifold <b>10-SV1000/10-SV2000/10-SV3000</b>
	<ul style="list-style-type: none"> <li>· Number of outputs: 32</li> <li>· Connected to the SI unit of the EX500</li> </ul>

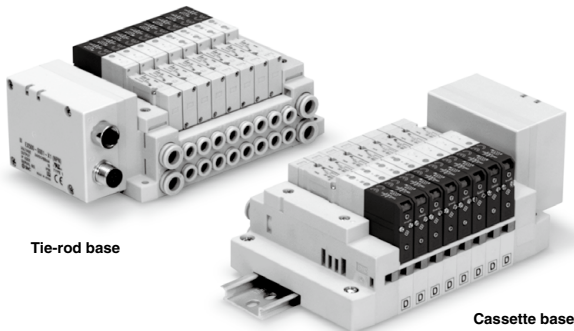

Tie-rod base

Cassette base

### EX500 Gateway Decentralized System **P.183**

Applicable series	Cassette base manifold <b>10-SV1000/10-SV2000</b>
	Tie-rod base manifold <b>10-SV1000/10-SV2000/10-SV3000/10-SV4000</b>
	<ul style="list-style-type: none"> <li>· Number of outputs: 16</li> <li>· Connected to the SI unit of the EX500</li> </ul>

Directional Control Valves

Air Cylinders

Rotary Actuators

Air Grippers

Air Preparation Equipment

Modular F. R.

Pressure Control Equipment

Fittings & Tubing

Flow Control Equipment

Pressure Switches/ Pressure Sensors



# 10-SV series EX500 Decentralized Serial Wiring



## How to Order Manifold

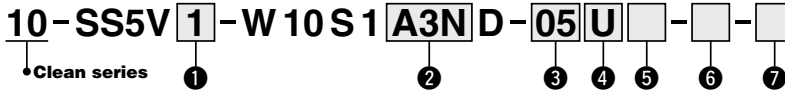

### 1 Series

1	10-SV1000
2	10-SV2000
3	10-SV3000

### 2 SI Unit (Number of outputs, Output polarity, Max. number of valve stations)

0	Without SI Unit
	32 outputs <i>Note 1, 3</i> ,
A3N	2 to 16 stations (20 stations <i>Note 2</i> )

- Note 1) 16 outputs can be set by switching the built-in setting switch.
- Note 2) ( ): Maximum number of stations for mixed single and double wiring.
- Note 3) When using the SI Unit with 32 outputs, use the GW Unit compatible with the EX500 Gateway Decentralized System 2 (128 points).

### 3 Valve stations

Symbol	Stations	Note
02	2 stations	Double wiring <i>Note 1</i> )
:	:	
16	16 stations	
02	2 stations	Specified layout <i>Note 2</i> ) (Available up to 32 solenoids)
:	:	
20	20 stations	

- Note 1) Double wiring: single, double, 3-position and 4-position valves can be used on all manifold stations.  
Use of a single solenoid will result in an unused control signal. If this is not desired, order with a specified layout.
- Note 2) Specified layout: Indicate the wiring specifications on the manifold specification sheet. (Note that double, 3-position and 4-position valves cannot be used where single wiring has been specified.)

### 4 P, E port entry

U	U side (2 to 10 stations)
D	D side (2 to 10 stations)
B	Both sides (2 to 20 stations)

### 5 SUP/EXH block assembly

NII	Internal pilot
R	External pilot

### 7 Mounting

NII	Direct mounting
D	With DIN bracket, DIN rail with standard length
D0	With DIN bracket, without DIN rail
D3 <i>Note</i>	With DIN bracket, DIN rail for 3 stations
:	:
D20 <i>Note</i>	With DIN bracket, DIN rail for 20 stations

*Note*) Specify a longer rail than the length of valve stations.

\* If the DIN rail must be mounted without an SI Unit, select "D0" and order the DIN rail separately. Refer to L3 of the dimensions for the DIN rail length. For the DIN rail part number, refer to the **WEB catalog** or the SV series catalog (CAT. ES11-81).

### 6 A, B port size

#### Metric size

Symbol	A, B port	P, E port	Applicable series
C3	ø3.2 One-touch fitting	ø8	10-SV1000
C4	ø4 One-touch fitting		
C6	ø6 One-touch fitting		
C4	ø4 One-touch fitting	ø10	10-SV2000
C6	ø6 One-touch fitting		
C8	ø8 One-touch fitting		
C6	ø6 One-touch fitting	ø12	10-SV3000
C8	ø8 One-touch fitting		
C10	ø10 One-touch fitting		
M <i>Note</i>	A, B port mixed		

#### Inch size

Symbol	A, B port	P, E port	Applicable series
N1	ø1/8" One-touch fitting	ø5/16"	10-SV1000
N3	ø5/32" One-touch fitting		
N7	ø1/4" One-touch fitting		
N3	ø5/32" One-touch fitting	ø3/8"	10-SV2000
N7	ø1/4" One-touch fitting		
N9	ø5/16" One-touch fitting		
N7	ø1/4" One-touch fitting	ø3/8"	10-SV3000
N9	ø5/16" One-touch fitting		
N11	ø3/8" One-touch fitting		
M <i>Note</i>	A, B port mixed		

*Note*) Indicate the sizes on the manifold specification sheet.

\* The X and PE port size of external pilot type [R] are ø4 (mm) or ø5/32" (inch) for the 10-SV1000/2000 series, and ø6 (mm) or ø1/4" (inch) for the 10-SV3000 series.

**How to Order Valves**

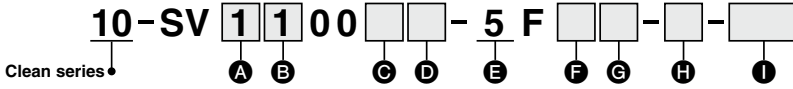

**A Series**

<b>1</b>	10-SV1000
<b>2</b>	10-SV2000
<b>3</b>	10-SV3000

**B Type of actuation**

<b>1</b>	2-position single
<b>2</b>	2-position double
<b>3</b>	3-position closed center
<b>4</b>	3-position exhaust center
<b>5</b>	3-position pressure center
<b>A Note)</b>	4-position dual 3-port valve (N.C./N.C.)
<b>B Note)</b>	4-position dual 3-port valve (N.O./N.O.)
<b>C Note)</b>	4-position dual 3-port valve (N.C./N.O.)

Note) Select the 10-SV1000 or 10-SV2000 series for the 4-position dual 3-port valve.  
 \* Select the internal pilot type for the 4-position dual 3-port valve.

**C Pilot type**

<b>Nii</b>	Internal pilot
<b>R</b>	External pilot

**D Back pressure check valve**

<b>Nii</b>	None
<b>K</b>	Built-in

\* Built-in back pressure check valve type is applicable to the 10-SV1000 series only.  
 \* The product with a back pressure check valve is not available for 3-position valves.  
 \* Refer to the **WEB catalog** for built-in back pressure check valve type.

**E Rated voltage**

<b>5</b>	24 VDC
----------	--------

**F Light/surge voltage suppressor**

<b>U</b>	With light/surge voltage suppressor
<b>R</b>	Without light, with surge voltage suppressor

**G Manual override**

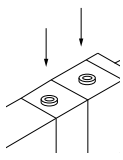
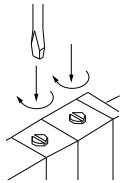
<b>Nii</b>	Non-locking push
	
<b>D</b>	Push-turn locking (slotted)
	

**H Manifold block**

If stations are to be added, order the product with manifold block.  
 (For details, refer to the **WEB catalog**.)

**I Made to Order**

<b>Nii</b>	—
<b>X90</b>	Main valve fluororubber specification (For details, refer to the <b>WEB catalog</b> .)

**How to Order Manifold Assembly**

**Example**

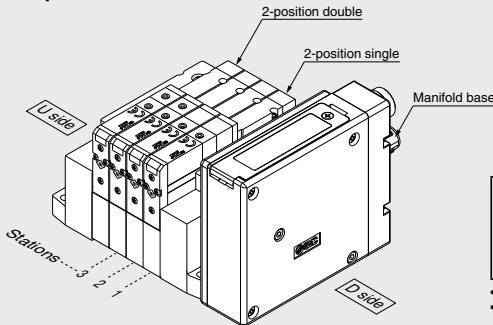

10-SSV1-W10S1A3ND-04B-C6.....1 set (Manifold base part number)  
 \* 10-SV1100-5FU.....2 sets (2-position single part number)  
 \* 10-SV1200-5FU.....2 sets (2-position double part number)

The asterisk denotes the symbol for assembly.  
 Prefix it to the part numbers of the valve etc.

- The valve arrangement is numbered as the 1st station from the D side.
- Under the manifold base part number, state the valves to be mounted in order from the 1st station as shown in the figure above. If the arrangement becomes complicated, specify on the manifold specification sheet.

Directional Control Valves  
 Air Cylinders  
 Rotary Actuators  
 Air Grippers  
 Air Preparation Equipment  
 Modular F. R.  
 Pressure Control Equipment  
 Fittings & Tubing  
 Flow Control Equipment  
 Pressure Switches/Pressure Sensors

**Dimensions**

**Tie-rod Base 10-SV1000 Series**

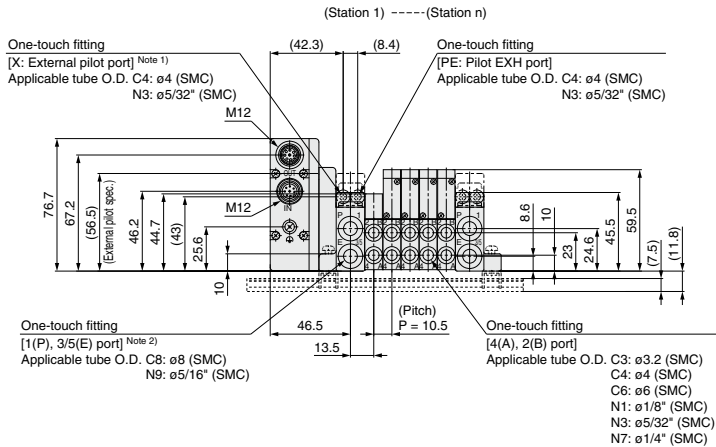
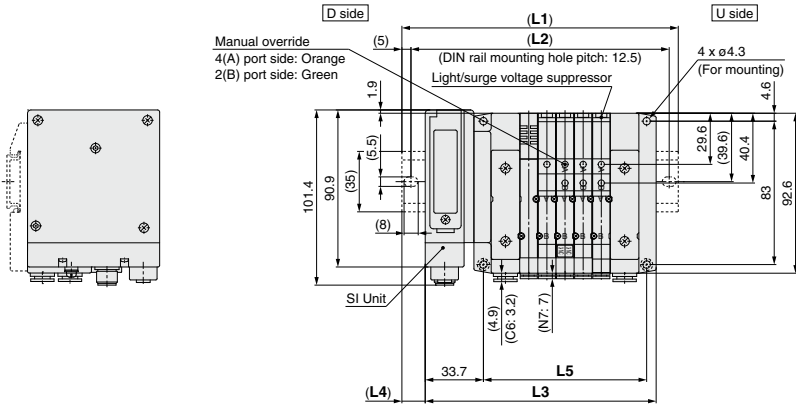

Note 1) External pilot port positions are the same as P, E port outlet positions.

Note 2) When P, E port outlets are indicated on the U side or D side, the P, E ports on the opposite side are plugged.

**L: DIN Rail Overall Length**

n: Stations

L \ n	2	3	4	5	6	7	8	9	10	11	12	13	14	15	16	17	18	19	20
<b>L1</b>	135.5	148	148	160.5	173	185.5	198	210.5	210.5	223	235.5	248	260.5	273	273	285.5	298	310.5	323
<b>L2</b>	125	137.5	137.5	150	162.5	175	187.5	200	200	212.5	225	237.5	250	262.5	262.5	275	287.5	300	312.5
<b>L3</b>	102.2	112.7	123.2	133.7	144.2	154.7	165.2	175.7	186.2	196.7	207.2	217.7	228.2	238.7	249.2	259.7	270.2	280.7	291.2
<b>L4</b>	16.5	17.5	12.5	13.5	14.5	15.5	16.5	17.5	12	13	14	15	16	17	12	13	14	15	16
<b>L5</b>	63	73.5	84	94.5	105	115.5	126	136.5	147	157.5	168	178.5	189	199.5	210	220.5	231	241.5	252

**Dimensions**

**Tie-rod Base 10-SV2000 Series**

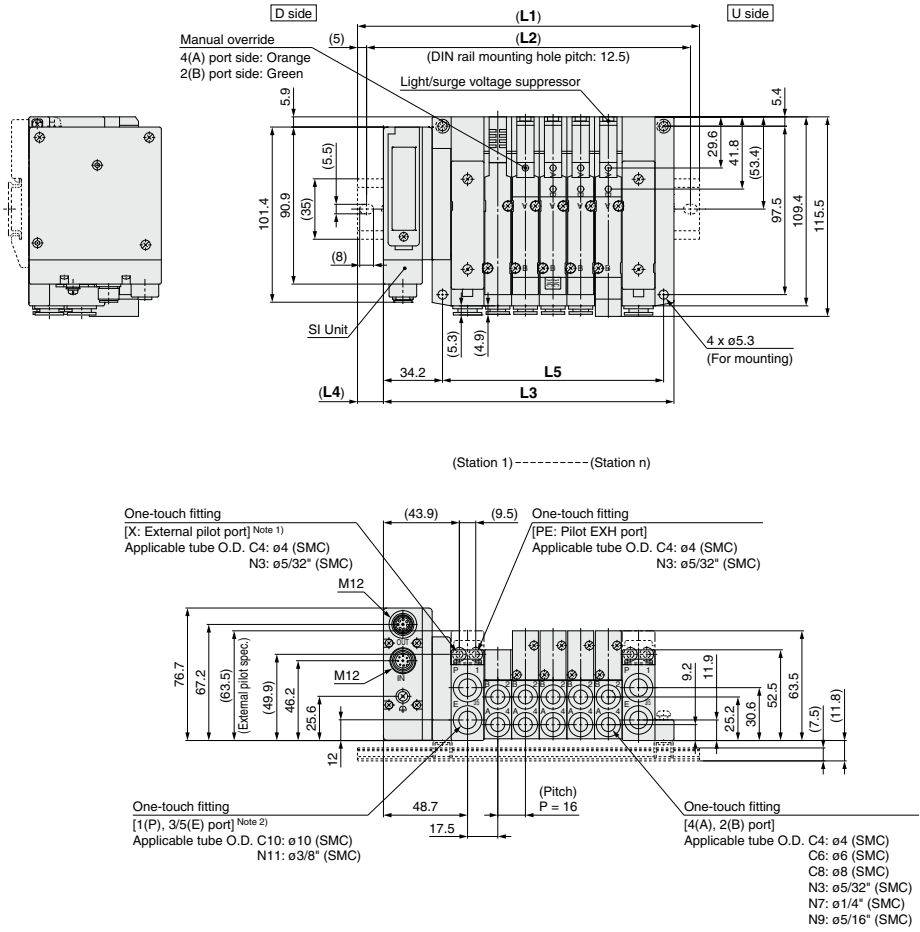

Note 1) External pilot port positions are the same as P, E port outlet positions.  
 Note 2) When P, E port outlets are indicated on the U side or D side, the P, E ports on the opposite side are plugged.

**L: DIN Rail Overall Length**

L \ n	2	3	4	5	6	7	8	9	10	11	12	13	14	15	16	17	18	19	20
<b>L1</b>	148	160.5	185.5	198	210.5	235.5	248	260.5	273	298	310.5	323	335.5	360.5	373	385.5	410.5	423	435.5
<b>L2</b>	137.5	150	175	187.5	200	225	237.5	250	262.5	287.5	300	312.5	325	350	362.5	375	400	412.5	425
<b>L3</b>	120.2	136.2	152.2	168.2	184.2	200.2	216.2	232.2	248.2	264.2	280.2	296.2	312.2	328.2	344.2	360.2	376.2	392.2	408.2
<b>L4</b>	14	12	16.5	15	13	17.5	16	14	12.5	17	15	13.5	11.5	16	14.5	12.5	17	15.5	13.5
<b>L5</b>	80	96	112	128	144	160	176	192	208	224	240	256	272	288	304	320	336	352	368

- Directional Control Valves
- Air Cylinders
- Rotary Actuators
- Air Grippers
- Air Preparation Equipment
- Modular F. R.
- Pressure Control Equipment
- Fittings & Tubing
- Flow Control Equipment
- Pressure Switches/ Pressure Sensors

**Dimensions**

**Tie-rod Base 10-SV3000 Series**

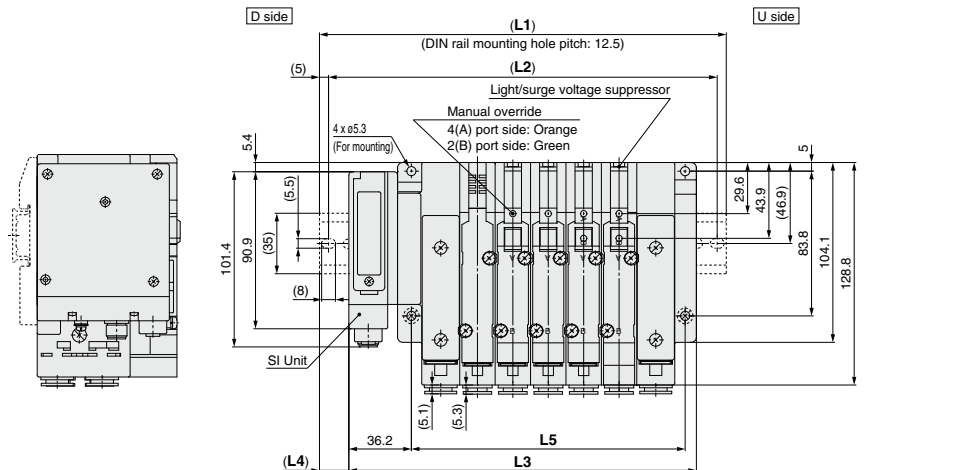

(Station 1) ----- (Station n)

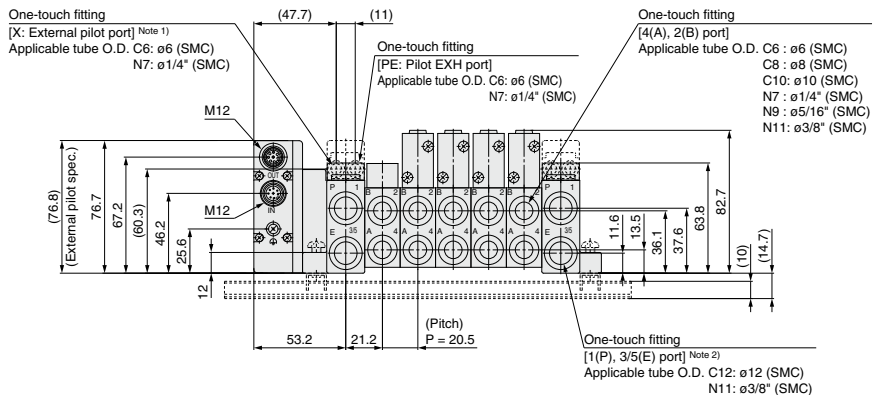

Note 1) External pilot port positions are the same as P, E port outlet positions.  
 Note 2) When P, E port outlets are indicated on the U side or D side, the P, E ports on the opposite side are plugged.

**L: DIN Rail Overall Length**

L \ n	2	3	4	5	6	7	8	9	10	11	12	13	14	15	16	17	18	19	20
<b>L1</b>	173	185.5	210.5	235.5	248	273	298	310.5	335.5	348	373	398	410.5	435.5	460.5	473	498	523	535.5
<b>L2</b>	162.5	175	200	225	237.5	262.5	287.5	300	325	337.5	362.5	387.5	400	425	450	462.5	487.5	512.5	525
<b>L3</b>	139.7	160.2	180.7	201.2	221.7	242.2	262.7	283.2	303.7	324.2	344.7	365.2	385.7	406.2	426.7	447.2	467.7	488.2	508.7
<b>L4</b>	16.5	12.5	15	17	13	15.5	17.5	13.5	16	12	14	16.5	12.5	14.5	17	13	15	17.5	13.5
<b>L5</b>	97	117.5	138	158.5	179	199.5	220	240.5	261	281.5	302	322.5	343	363.5	384	404.5	425	445.5	466

n: Stations





**How to Order Valves**

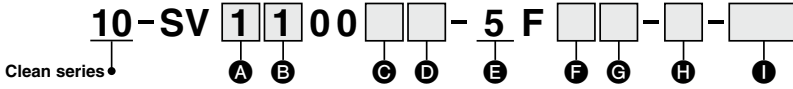

**A Series**

1	10-SV1000
2	10-SV2000
3	10-SV3000
4	10-SV4000

**B Type of actuation**

1	2-position single
2	2-position double
3	3-position closed center
4	3-position exhaust center
5	3-position pressure center

**A Note**) 4-position dual 3-port valve (N.C./N.C.)

**B Note**) 4-position dual 3-port valve (N.O./N.O.)

**C Note**) 4-position dual 3-port valve (N.C./N.O.)

Note) Select the 10-SV1000 or 10-SV2000 series for the 4-position dual 3-port valve.

\* Select the internal pilot type for the 4-position dual 3-port valve.

**C Pilot type**

Nii	Internal pilot
R	External pilot

**D Back pressure check valve**

Nii	None
K	Built-in

\* Built-in back pressure check valve type is applicable to the 10-SV1000 series only.

\* The product with a back pressure check valve is not available for 3-position valves.

\* Refer to the **WEB catalog** for built-in back pressure check valve type.

**E Rated voltage**

5	24 VDC
---	--------

**F Light/surge voltage suppressor**

U	With light/surge voltage suppressor
R	Without light, with surge voltage suppressor

**G Manual override**

Nii	Non-locking push
-----	------------------

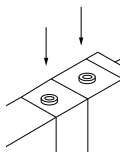

D	Push-turn locking (slotted)
---	-----------------------------

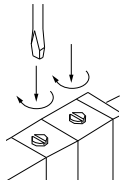

**H Manifold block**

If stations are to be added, order the product with manifold block.

(For details, refer to the **WEB catalog**.)

**I Made to Order**

Nii	—
X90	Main valve fluororubber specification (For details, refer to the <b>WEB catalog</b> .)

**How to Order Manifold Assembly**

**Example**

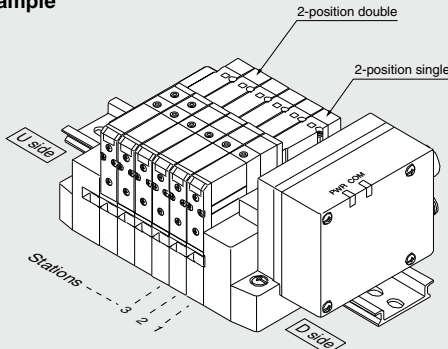

- 10-SS5V1-W16SA2WD-06B-C6.....1 set (Manifold base part number)
- \* 10-SV1100-5FU.....4 sets (2-position single part number)
- \* 10-SV1200-5FU.....2 sets (2-position double part number)

The asterisk denotes the symbol for assembly. Prefix it to the part numbers of the valve etc.

- The valve arrangement is numbered as the 1st station from the D side.
- Under the manifold base part number, state the valves to be mounted in order from the 1st station as shown in the figure above. If the arrangement becomes complicated, specify on the manifold specification sheet.

Directional Control Valves  
Air Cylinders  
Rotary Actuators  
Air Grippers  
Air Preparation Equipment  
Modular F. R.  
Pressure Control Equipment  
Fittings & Tubing  
Flow Control Equipment  
Pressure Switches/Pressure Sensors



**Dimensions**

**Cassette Base 10-SV1000 Series**

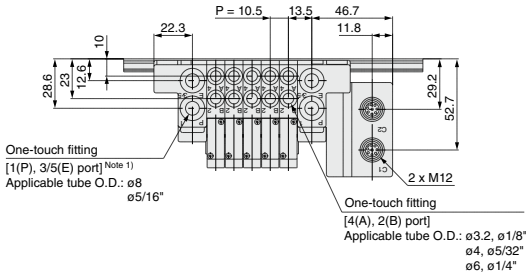

**With External Pilot Specification**

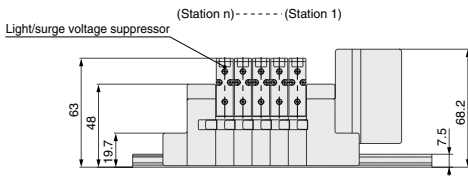
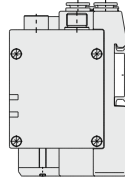
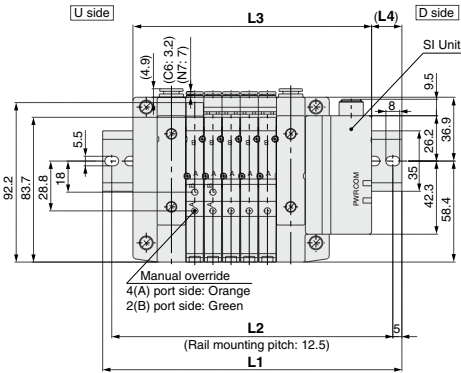
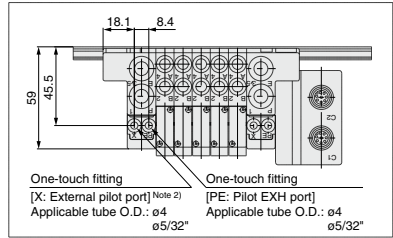

**With Option**

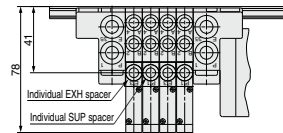

Note 1) When P, E port outlets are indicated on the U side or D side, the P, E ports on the opposite side are plugged.  
 Note 2) External pilot port positions are the same as P, E port outlet positions.

**L: Dimensions**

n: Stations

L	n	2	3	4	5	6	7	8	9	10	11	12	13	14	15	16
L1		135.5	148	160.5	173	173	185.5	198	210.5	223	235.5	248	260.5	273	285.5	
L2		125	137.5	150	162.5	162.5	175	187.5	200	212.5	225	225	237.5	250	262.5	275
L3		106.5	117	127.5	138	148.5	159	169.5	180	190.5	201	211.5	222	232.5	243	253.5
L4		14.5	15.5	16.5	17.5	12.5	13.5	14.5	15.5	16.5	17.5	12	13	14	15	16

Dimensions

Cassette Base 10-SV2000 Series

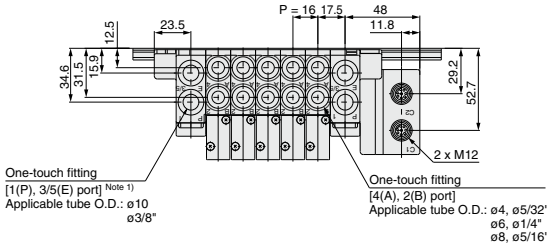

With External Pilot Specification

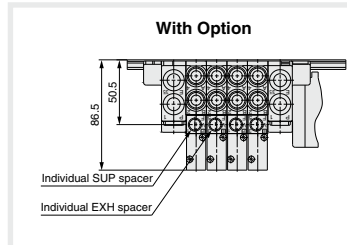
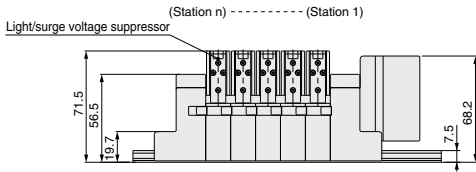
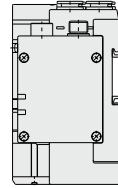
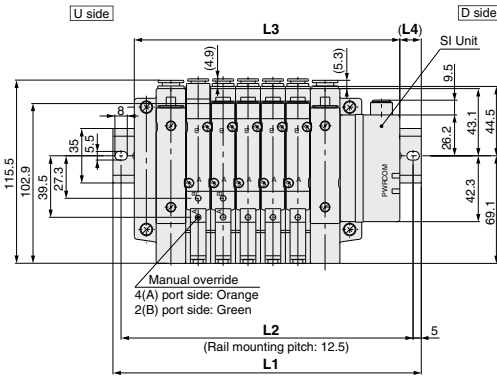
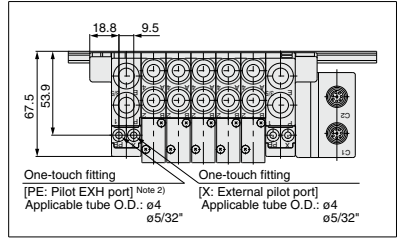

Note 1) When P, E port outlets are indicated on the U side or D side, the P, E ports on the opposite side are plugged.  
 Note 2) External pilot port positions are the same as P, E port outlet positions.

L: Dimensions

L	n	2	3	4	5	6	7	8	9	10	11	12	13	14	15	16
L1	n: Stations	148	173	185.5	198	210.5	235.5	248	260.5	285.5	298	310.5	323	348	360.5	373
L2		137.5	162.5	175	187.5	200	225	237.5	250	275	287.5	300	312.5	337.5	350	362.5
L3		122.5	138.5	154.5	170.5	186.5	202.5	218.5	234.5	250.5	266.5	282.5	298.5	314.5	330.5	346.5
L4		13	17.5	15.5	14	12	16.5	15	13	17.5	16	14	12.5	17	15	13.5

Directional Control Valves  
 Air Cylinders  
 Rotary Actuators  
 Air Grippers  
 Air Preparation Equipment  
 Modular F. R.  
 Pressure Control Equipment  
 Fittings & Tubing  
 Flow Control Equipment  
 Pressure Switches/ Pressure Sensors

**Dimensions**

**Tie-rod Base 10-SV1000 Series**

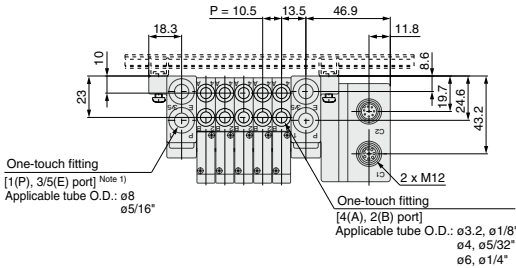

**With External Pilot Specification**

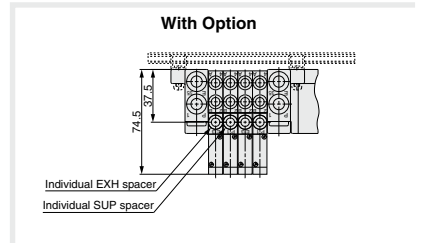
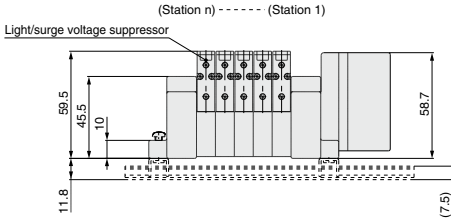
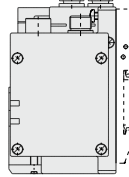
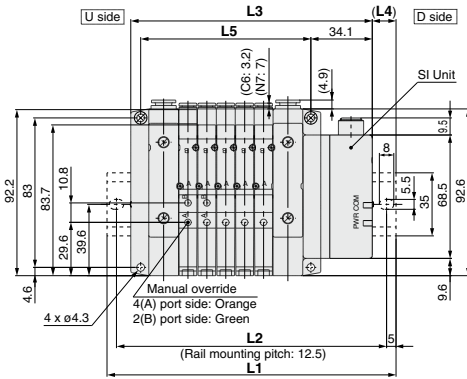
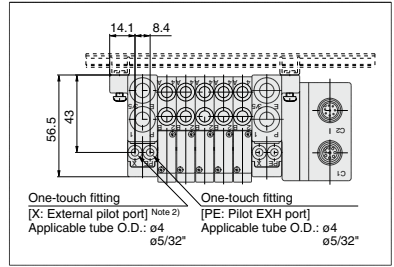

Note 1) When P, E port outlets are indicated on the U side or D side, the P, E ports on the opposite side are plugged.

Note 2) External pilot port positions are the same as P, E port outlet positions.

**L: Dimensions**

n: Stations

L	n	2	3	4	5	6	7	8	9	10	11	12	13	14	15	16
L1		135.5	148	148	160.5	173	185.5	198	210.5	210.5	223	235.5	248	260.5	273	273
L2		125	137.5	137.5	150	162.5	175	187.5	200	200	212.5	225	237.5	250	262.5	262.5
L3		102.6	113.1	123.6	134.1	144.6	155.1	165.6	176.1	186.6	197.1	207.6	218.1	228.6	239.1	249.6
L4		16.5	17.5	12	13	14	15	16	17	12	13	14	15	16	17	11.5
L5		63	73.5	84	94.5	105	115.5	126	136.5	147	157.5	168	178.5	189	199.5	210



**Dimensions**

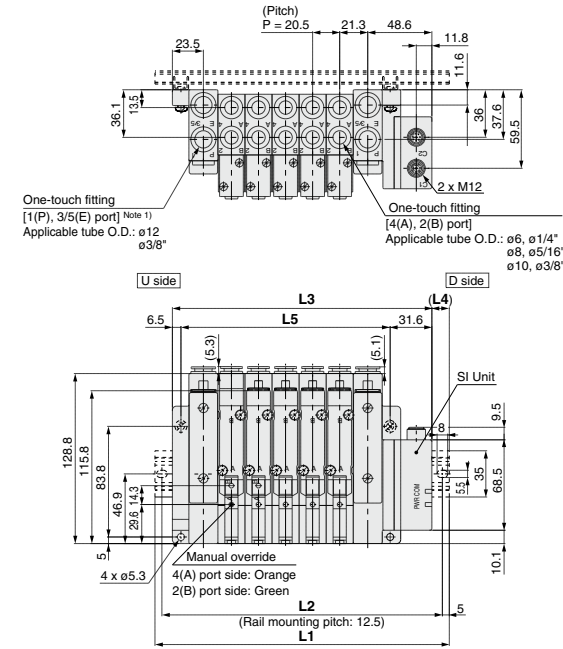

**With External Pilot Specification**

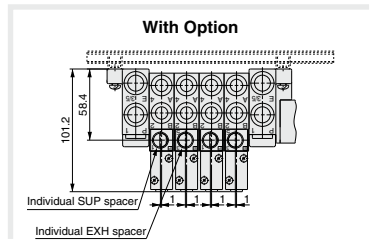
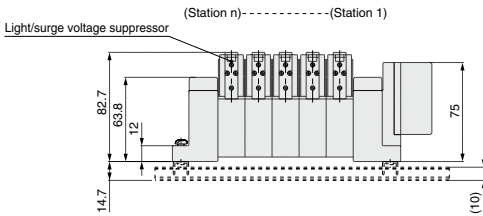
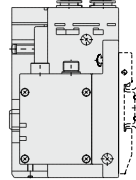
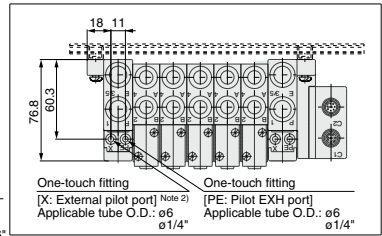

Note 1) When P, E port outlets are indicated on the U side or D side, the P, E ports on the opposite side are plugged.  
Note 2) External pilot port positions are the same as P, E port outlet positions.

**L: Dimensions**

n: Stations

L	n	2	3	4	5	6	7	8	9	10	11	12	13	14	15	16
L1		160.5	185.5	210.5	223	248	273	285.5	310.5	323	348	373	385.5	410.5	435.5	448
L2		150	175	200	212.5	237.5	262.5	275	300	312.5	337.5	362.5	375	400	425	437.5
L3		135.1	155.6	176.1	196.6	217.1	237.6	258.1	278.6	299.1	319.6	340.1	360.6	381.1	401.6	422.1
L4		12.5	15	17	13	15.5	17.5	13.5	16	12	14	16.5	12.5	14.5	17	13
L5		97	117.5	138	158.5	179	199.5	220	240.5	261	281.5	302	322.5	343	363.5	384

**Dimensions**

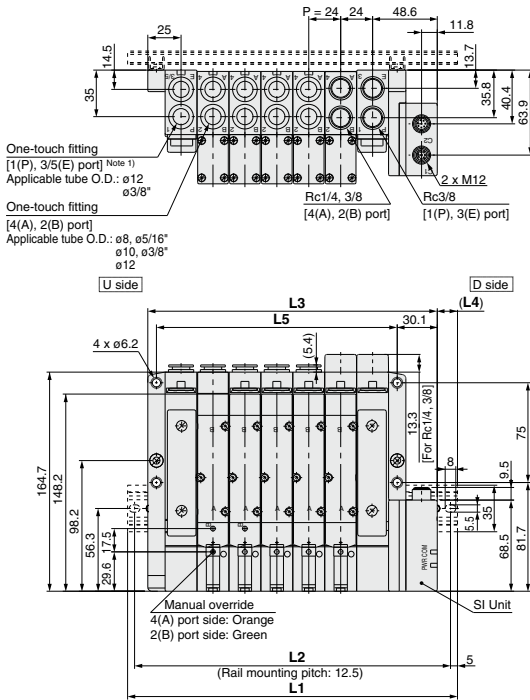

**With External Pilot Specification**

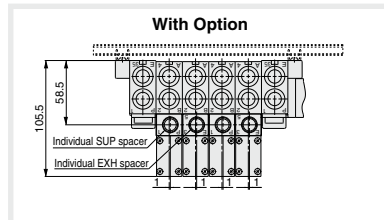
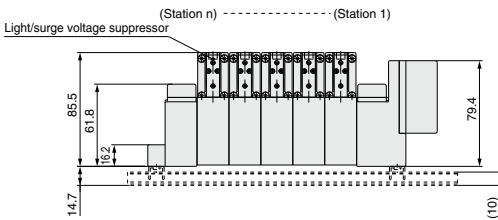
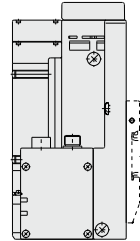
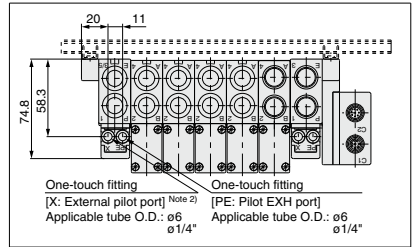

Note 1) When P, E port outlets are indicated on the U side or D side, the P, E ports on the opposite side are plugged.  
 Note 2) External pilot port positions are the same as P, E port outlet positions.

**L: Dimensions**

L	n	2	3	4	5	6	7	8	9	10	11	12	13	14	15	16
L1	173	198	223	248	273	298	323	348	373	385.5	410.5	435.5	460.5	485.5	510.5	
L2	162.5	187.5	212.5	237.5	262.5	287.5	312.5	337.5	362.5	375	400	425	450	475	500	
L3	145.6	169.6	193.6	217.6	241.6	265.6	289.6	313.6	337.6	361.6	385.6	409.6	433.6	457.6	481.6	
L4	13.5	14	14.5	15	15.5	16	16.5	17	17.5	18	18.5	19	19.5	20	20.5	21
L5	109	133	157	181	205	229	253	277	301	325	349	373	397	421	445	

n: Stations

Directional Control Valves  
 Air Cylinders  
 Rotary Actuators  
 Air Grippers  
 Air Preparation Equipment  
 Modular F. R.  
 Pressure Control Equipment  
 Fittings & Tubing  
 Flow Control Equipment  
 Pressure Switches/ Pressure Sensors



# Serial Wiring with Input/Output Unit

## Series EX250

IP67 compliant

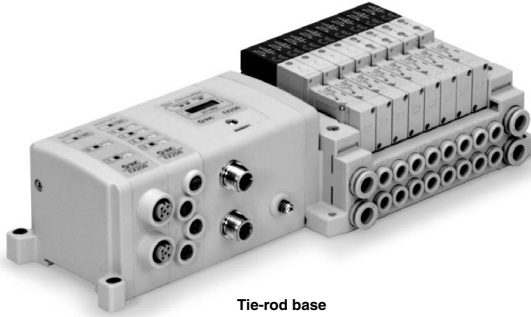

Tie-rod base

Applicable series	Tie-rod base manifold <b>10-SV1000/10-SV2000/10-SV3000</b>
	· Number of inputs/outputs: 32 each

Directional  
Control Valves

Air Cylinders

Rotary Actuators

Air Grippers

Air Preparation  
Equipment

Modular F. R.

Pressure Control  
Equipment

Fittings & Tubing

Flow Control  
Equipment

Pressure Switches/  
Pressure Sensors



# Series 10-SV

EX250 Serial Wiring with Input/Output Unit



## How to Order

### • Tie-rod base

10 - SS5V 1 - W10S1 QW [ ] [ ] [ ] D - 05 U [ ] - [ ] - [ ]

• Clean series

• Series

1	SV1000
2	SV2000
3	SV3000

• Enclosure  
IP67

• Input block stations

Nil	None
1	1 station
:	:
8	8 stations

(Note) The symbol is nil for no SI unit.

• Input block type

Nil	Without input block	
1	M12, 2 inputs	EX250-IE1
2	M12, 4 inputs	EX250-IE2
3	M8, 4 inputs	EX250-IE3

(Note) The symbol is nil for no SI unit.

• Input block specifications

Nil	PNP sensor input (Positive common) or without input block
N	NPN sensor input (Negative common)

• Valve stations

Symbol	Stations	Note
02	2 stations	Double wiring (Note 1)
:	:	
16	16 stations	Specified layout (Up to 32 solenoids possible)
02	2 stations	
:	:	
20	20 stations	

• When the SI unit is for AS-i, the maximum numbers of solenoids are as follows.

TAW, TCW: Maximum 8 solenoids  
TBW, TDW: Maximum 4 solenoids

Note 1) Double wiring: Single, double, 3 position and 4 position solenoid valves can be used on all manifold stations. Use of a single solenoid will result in an unused control signal. If this is not desired, order with a specified layout.

Note 2) Specified layout: Indicate wiring specifications on the manifold specification sheet. (Note that double, 3 position and 4 position valves cannot be used where single solenoid wiring has been specified.)

• SI unit

Symbol	Protocol type
0	Without SI unit
QW	DeviceNet®
TAW	AS-Interface (8 in/8 out, 2 power supply systems)
TBW	AS-Interface (4 in/4 out, 2 power supply systems)
TCW (Note)	AS-Interface (8 in/8 out, 1 power supply system)
TDW (Note)	AS-Interface (4 in/4 out, 1 power supply system)
ZEN	EtherNet/IP™

• Input blocks cannot be mounted without SI unit.

• When the DIN rail is included without an SI unit, the DIN rail length will accommodate an SI unit and one input block.

(Note) There is a limit to the supply current to the input block and valve from SI units that have AS-Interface-compliant 1 power supply system. For details, refer to the **WEB catalog**.

• P, E port location

U	U side (2 to 10 stations)
D	D side (2 to 10 stations)
B	Both sides (2 to 20 stations)

• SUP/EXH block assembly

Nil	Internal pilot
R	External pilot

• A, B port size (Metric)

Symbol	A, B port	P, E port	Applicable series
C3	ø3.2 One-touch fitting	ø8 One-touch fitting	10-SV1000
C4	ø4 One-touch fitting		
C6	ø6 One-touch fitting		
C4	ø4 One-touch fitting	ø10 One-touch fitting	10-SV2000
C6	ø6 One-touch fitting		
C8	ø8 One-touch fitting	ø12 One-touch fitting	10-SV3000
C6	ø6 One-touch fitting		
C8	ø8 One-touch fitting		
C10	ø10 One-touch fitting		
M	Mixed		

• A, B port size (Inch)

Symbol	A, B port	P, E port	Applicable series
N3	ø1/8" One-touch fitting	ø5/16" One-touch fitting	10-SV1000
N3	ø5/32" One-touch fitting		
N7	ø1/4" One-touch fitting		
N3	ø5/32" One-touch fitting	ø3/8" One-touch fitting	10-SV2000
N7	ø1/4" One-touch fitting		
N9	ø5/16" One-touch fitting	ø3/8" One-touch fitting	10-SV3000
N7	ø1/4" One-touch fitting		
N9	ø5/16" One-touch fitting		
N11	ø3/8" One-touch fitting		
M	Mixed		

• Mounting

Nil	Direct mounting
D	DIN rail mounting (With DIN rail)
D0*	DIN rail mounting (Without DIN rail)
D3	For 3 stations: When a longer DIN rail is desired than the specified stations
:	:
D20	For 20 stations: (Specify a longer rail than the standard length.)

(Note) For D0, only DIN rail mounting bracket is attached.

\* For mixed specifications (M), indicate separately on the manifold specification sheet.

\* External pilot type (R) X, PE port sizes are ø4 (metric), ø5/32" (inch) for the 10-SV1000/2000 series and ø6 (metric), ø1/4" (inch) for the 10-SV3000 series.

## How to Order Valve Manifold Assembly

### Ordering example (10-SV1000)

#### Manifold

10-SS5V1-W10S1QW11ND-05B-C6 (1 set)

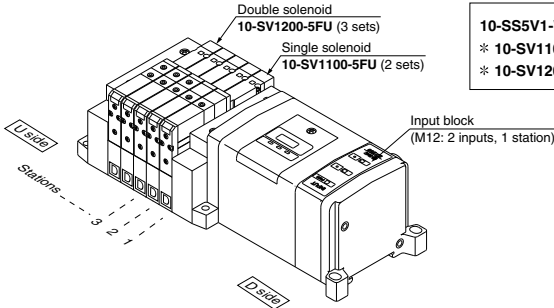

**10-SS5V1-W10S1QW11ND-05B-C6**.....1 set (Manifold part no.)  
 \* **10-SV1100-5FU**.....2 sets (Single solenoid part no.)  
 \* **10-SV1200-5FU**.....3 sets (Double solenoid part no.)

## How to Order Solenoid Valve

**10 - SV 1 1 00** - **5 F** - **Note**

Clean series

Series

1	10-SV1000
2	10-SV2000
3	10-SV3000

Actuation type

1	2 position single solenoid
2	2 position double solenoid
3	3 position closed center
4	3 position exhaust center
5	3 position pressure center
A	4 position dual 3 port valve: N.C./N.C.
B	4 position dual 3 port valve: N.O./N.O.
C	4 position dual 3 port valve: N.C./N.O.

\* 4 position dual 3 port valves are applicable to the 10-SV1000/10-SV2000 series only.

Pilot type

Nil	Internal pilot
R	External pilot

\* External pilot specifications are not available for 4 position dual 3 port valves.

Back pressure check valve

Nil	None
K	Built-in

\* The built-in back pressure check valve type is applicable to the 10-SV1000 series only.  
 \* The product with back pressure check valve is not available for 3 position valves.

Note) Available with manifold block for station additions. Refer to the **WEB catalog**.

Made to Order

Nil	-
X90	Main valve fluororubber (Refer to page 272.)

Manual override

Nil: Non-locking push type	D: Push-turn locking slotted type
----------------------------	-----------------------------------

Light/surge voltage suppressor

U	With light/surge voltage suppressor
R	With surge voltage suppressor

Rated voltage

5	24 VDC
---	--------

Note) Refer to the Specific Product Precautions 2 on page 274.

Directional Control Valves  
 Air Cylinders  
 Rotary Actuators  
 Air Grippers  
 Air Preparation Equipment  
 Modular F. R.  
 Pressure Control Equipment  
 Fittings & Tubing  
 Flow Control Equipment  
 Pressure Switches/ Pressure Sensors



**Dimensions: Series 10-SV2000 for EX250 Serial Wiring with Input/Output Unit**

• **Tie-rod base manifold: 10-SS5V2-W10S1□□□□D- Stations  U  D  R)  C4, N3  C6, N7  C8, N9  (-D)**

(With 2 input blocks)

• When P, E port outlets are indicated on the U side or D side, the P, E ports on the opposite side are plugged.  
 • External pilot port positions are the same as P, E port outlet positions.

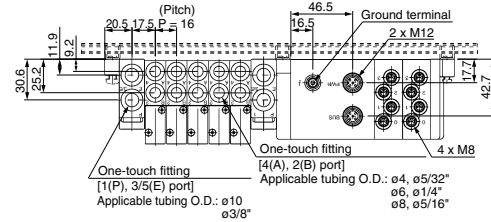

With external pilot specifications

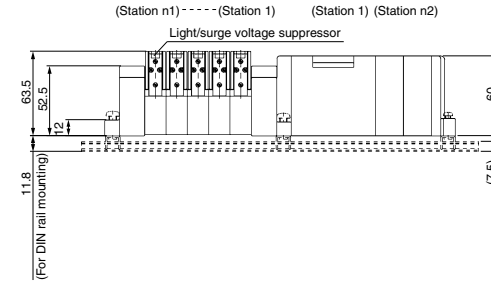
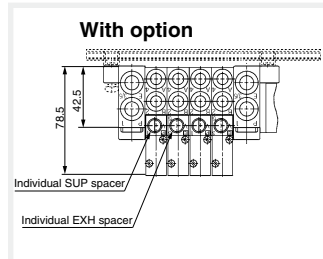
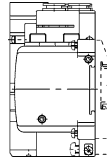
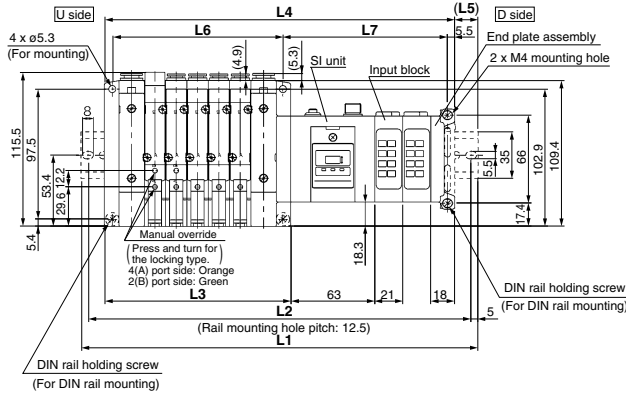
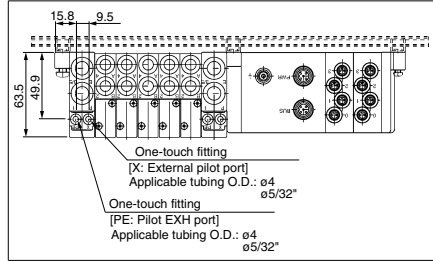

n1 = Valve stations  
n2 = Input block stations

L2 = L1 - 10.5  
 L3 = 16 x n1 + 60  
 L4 = L3 + 81 + 21 x n2  
 L5 = (L1 - L4)/2  
 L6 = 16 x n1 + 48  
 L7 = 21 x n2 + 81.5

**L1: DIN rail overall length**

Valve stations (n2)	2	3	4	5	6	7	8	9	10	11	12	13	14	15	16	17	18	19	20
0	198	223	235.5	248	260.5	285.5	298	310.5	335.5	348	360.5	373	398	410.5	423	448	460.5	473	485.5
1	223	235.5	260.5	273	285.5	298	323	335.5	348	373	385.5	398	410.5	435.5	448	460.5	485.5	498	510.5
2	248	260.5	273	298	310.5	323	335.5	360.5	373	385.5	410.5	423	435.5	448	473	485.5	498	510.5	535.5
3	260.5	285.5	298	310.5	335.5	348	360.5	373	398	410.5	423	435.5	460.5	473	485.5	510.5	523	535.5	548
4	285.5	298	323	335.5	348	360.5	385.5	398	410.5	435.5	448	460.5	473	498	510.5	523	548	560.5	573
5	310.5	323	335.5	360.5	373	385.5	398	423	435.5	448	473	485.5	498	510.5	535.5	548	560.5	585.5	598
6	323	348	360.5	373	398	410.5	423	435.5	460.5	473	485.5	510.5	523	535.5	548	573	585.5	598	610.5
7	348	360.5	385.5	398	410.5	435.5	448	460.5	473	498	510.5	523	535.5	560.5	573	585.5	610.5	623	635.5
8	373	385.5	398	423	435.5	448	460.5	485.5	498	510.5	535.5	548	560.5	573	598	610.5	623	648	660.5

Directional Control Valves  
 Air Cylinders  
 Rotary Actuators  
 Air Grippers  
 Air Preparation Equipment  
 Modular F. R.  
 Pressure Control Equipment  
 Fittings & Tubing  
 Flow Control Equipment  
 Pressure Switches/ Pressure Sensors

**Dimensions: Series 10-SV3000 for EX250 Serial Wiring with Input/Output Unit**

• **Tie-rod base manifold: 10-SS5V3-W10S1□□□□D-<sup>U</sup><sub>D</sub> B (R)-<sup>C6, N7</sup><sub>C8, N9</sub> C10, N11 (-)D**

(With 2 input blocks)

• When P, E port outlets are indicated on the U side or D side, the P, E ports on the opposite side are plugged.  
 • External pilot port positions are the same as P, E port outlet positions.

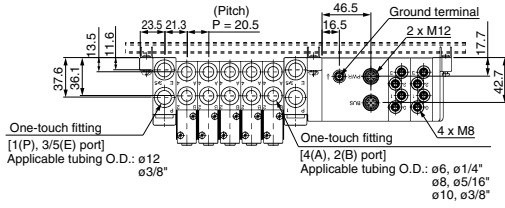

**With external pilot specifications**

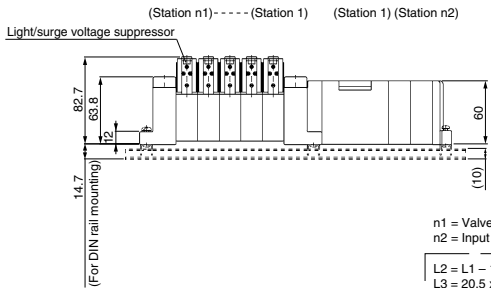
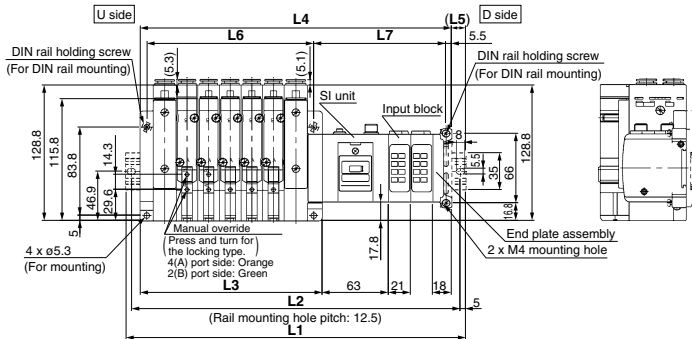
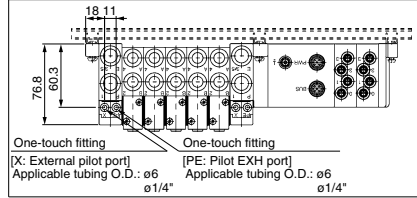

n1 = Valve stations  
 n2 = Input block stations

L2 = L1 - 10.5  
 L3 = 20.5 x n1 + 70.5  
 L4 = L3 + 81 + 21 x n2  
 L5 = (L1 - L4)/2  
 L6 = 20.5 x n1 + 56  
 L7 = 21 x n2 + 83.5

**With option**

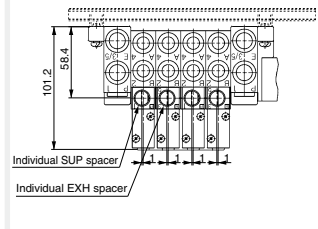

**L1: DIN rail overall length**

Valve stations (n1) Input block stations (n2)	2	3	4	5	6	7	8	9	10	11	12	13	14	15	16	17	18	19	20
0	223	248	260.5	285.5	298	323	348	360.5	385.5	410.5	423	448	473	485.5	510.5	535.5	548	573	585.5
1	248	260.5	285.5	310.5	323	348	360.5	385.5	410.5	423	448	473	485.5	510.5	535.5	548	573	585.5	610.5
2	260.5	285.5	310.5	323	348	360.5	385.5	410.5	423	448	473	485.5	510.5	535.5	548	573	598	610.5	635.5
3	285.5	310.5	323	348	373	385.5	410.5	423	448	473	485.5	510.5	535.5	548	573	598	610.5	635.5	648
4	310.5	323	348	373	385.5	410.5	423	448	473	485.5	510.5	535.5	548	573	598	610.5	635.5	660.5	673
5	323	348	373	385.5	410.5	435.5	448	473	485.5	510.5	535.5	548	573	598	610.5	635.5	660.5	673	698
6	348	373	385.5	410.5	435.5	448	473	485.5	510.5	535.5	548	573	598	610.5	635.5	660.5	673	698	723
7	373	385.5	410.5	435.5	448	473	498	510.5	535.5	548	573	598	610.5	635.5	660.5	673	698	723	735.5
8	385.5	410.5	435.5	448	473	498	510.5	535.5	548	573	598	610.5	635.5	660.5	673	698	723	735.5	760.5

# Integrated Type (For Input/Output) Serial Transmission System

## Series **EX600**

IP67 compliant

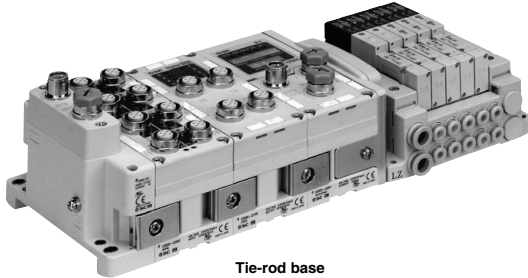

Tie-rod base

Applicable series	Tie-rod base manifold 10-SV1000/10-SV2000/10-SV3000
	<ul style="list-style-type: none"><li>· Digital inputs/outputs: Max. 144/144</li><li>· Analog input: Max. 18 channels</li><li>· Number of valve outputs: 32</li></ul>

Directional  
Control Valves

Air Cylinders

Rotary Actuators

Air Grippers

Air Preparation  
Equipment

Modular F. R.

Pressure Control  
Equipment

Fittings & Tubing

Flow Control  
Equipment

Pressure Switches/  
Pressure Sensors

# Series 10-SV



Refer to Best Pneumatics No. 1-1 and the Operation Manual for the details of EX600 Integrated-type (For I/O) Serial Transmission System. Please download the Operation Manual via our website, <http://www.smcworld.com>

## EX600 Integrated-type (For Input/Output) Serial Transmission System

When I/O Unit EX600-D□□E or EX600-D□□F are selected, enclosure is IP40.  
For details, refer to the **WEB catalog**.

### How to Order Manifold

The 1-port EtherNet/IP compatible SI unit is to be discontinued as of March 2022. Please consider ordering the 2-port EtherNet/IP compatible SI unit as a substitute.

#### SI unit specifications

Discontinued model no. ZE  
Substitute model no. EA

#### ● Tie-rod base

10-SS5V **1** - **10S6** **Q** **D** - **05** **U** - **C6**

Series	Enclosure
1 10-SV1000	Nil IP40
2 10-SV2000	W (Note) IP67
3 10-SV3000	

(Note) When selecting an EX600-D□□E or EX600-D□□F I/O unit, option W (IP67) cannot be selected.

#### SI Unit

0	Without SI Unit
Q	DeviceNet® (Version A)
N	PROFIBUS DP (Version A)
V	CC-Link
ZE	EtherNet/IP™ (1 port)
EA	EtherNet/IP™ (2 port)
F	PROFINET
D	EtherCAT
WE	EtherNet/IP™ compatible wireless base (Note 3)
WF	PROFINET compatible wireless base (Note 3)
WS	Wireless remote (Note 3)

Note 1) When "Without SI Unit" is specified, I/O Unit cannot be mounted.  
Note 2) When "Without SI Unit" is specified, a valve plate which connects the valve manifold and SI Unit, is not mounted. Refer to the **WEB catalog** for mounting method.  
Note 3) The wireless system is suitable for use only in a country where it is in accordance with the Radio Act and regulations of that country.

#### End plate type

Nil	No end plate
2	M12 power supply connector B-coded
3	7/8 inch power supply connector
4	M12 power supply connector IN/OUT, A-coded, Pin arrangement 1
5	M12 power supply connector IN/OUT, A-coded, Pin arrangement 2

#### SI Unit common

Nil	Positive common
N	Negative common

(Note) The symbol is nil for no SI Unit.

#### I/O Unit stations

Nil	None
1	1 station
⋮	⋮
9	9 stations

Note 1) The symbol is nil for no SI Unit.  
Note 2) SI Unit is not included in I/O Unit stations.  
Note 3) When I/O Unit is selected, it is shipped separately and assembled by users.  
Refer to the attached operation manual for mounting method.

#### Valve stations

Symbol	Stations	Note
02	2 stations	Double wiring (Note 1)
⋮	⋮	
16	16 stations	Specified layout (Note 2) (Available up to 32 solenoids)
02	2 stations	
⋮	⋮	
20	20 stations	

Note 1) Double wiring: Single, double, 3-position and 4-position valves can be used on all manifold stations.

Note 2) Specified layout: Indicate the wiring specifications on the manifold specification sheet. (Note that double, 3-position and 4-position valves cannot be used where single wiring has been specified.)

#### A, B port size (Metric)

Symbol	A, B port	P, E port	Applicable series
C3	ø3.2 One-touch fitting	ø8 One-touch fitting	10-SV1000
C4	ø4 One-touch fitting		
C6	ø6 One-touch fitting	ø10 One-touch fitting	10-SV2000
C4	ø4 One-touch fitting		
C6	ø6 One-touch fitting	ø12 One-touch fitting	10-SV3000
C8	ø8 One-touch fitting		
C6	ø6 One-touch fitting	ø10 One-touch fitting	10-SV1000
C8	ø8 One-touch fitting		
C10	ø10 One-touch fitting	ø8 One-touch fitting	10-SV2000
M	Mixed		

#### A, B port size (Inch)

Symbol	A, B port	P, E port	Applicable series
N1	ø1/8" One-touch fitting	ø5/16" One-touch fitting	10-SV1000
N3	ø5/32" One-touch fitting		
N7	ø1/4" One-touch fitting	ø3/8" One-touch fitting	10-SV2000
N3	ø5/32" One-touch fitting		
N7	ø1/4" One-touch fitting	ø3/8" One-touch fitting	10-SV3000
N9	ø5/16" One-touch fitting		
N7	ø1/4" One-touch fitting	ø3/8" One-touch fitting	10-SV1000
N9	ø5/16" One-touch fitting		
N11	ø3/8" One-touch fitting	ø3/8" One-touch fitting	10-SV2000
M	Mixed		

\* For mixed specifications (M), indicate separately on the manifold specification sheet.

\* External pilot type (R) X, PE port sizes are ø4 (mm) or ø5/32" (inch) for the 10-SV1000/2000 series, and ø6 (mm) or ø1/4" (inch) for the 10-SV3000 series.





**Dimensions: Series 10-SV1000**

**Power supply with M12 connector**

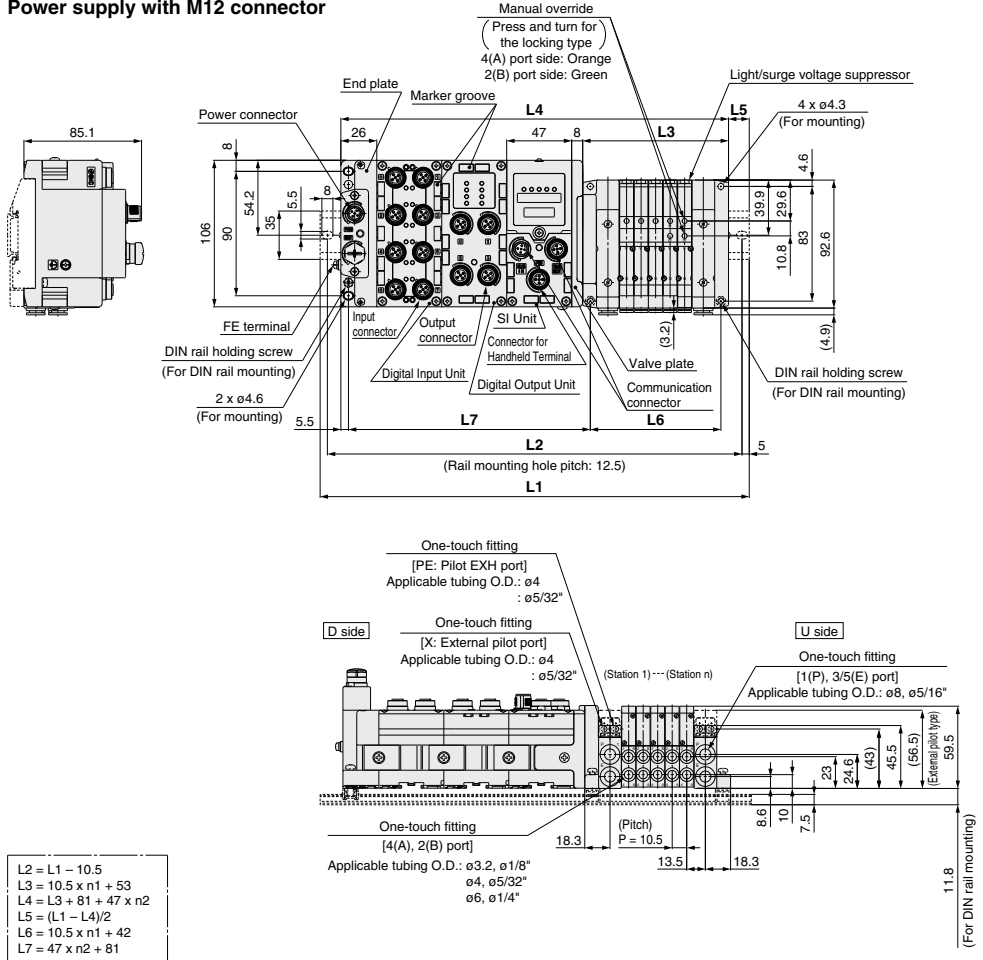

**L1: DIN Rail Overall Length**

I/O Unit stations (n2) \ Valve stations (n1)	2	3	4	5	6	7	8	9	10	11	12	13	14	15	16	17	18	19	20
0	185.5	198	210.5	210.5	223	235.5	248	260.5	273	273	285.5	298	310.5	323	335.5	348	348	360.5	373
1	235.5	248	248	260.5	273	285.5	298	310.5	310.5	323	335.5	348	360.5	373	385.5	398	410.5	423	423
2	273	285.5	298	310.5	323	335.5	335.5	348	360.5	373	385.5	398	410.5	410.5	423	435.5	448	460.5	473
3	323	335.5	348	360.5	373	373	385.5	398	410.5	423	435.5	435.5	448	460.5	473	485.5	498	498	510.5
4	373	385.5	398	398	410.5	423	435.5	448	460.5	473	473	485.5	498	510.5	523	535.5	548	548	560.5
5	423	435.5	435.5	448	460.5	473	485.5	498	498	510.5	523	535.5	548	560.5	560.5	573	585.5	598	610.5
6	460.5	473	485.5	498	510.5	523	535.5	535.5	548	560.5	573	585.5	598	598	610.5	623	635.5	648	660.5
7	510.5	523	535.5	548	560.5	560.5	573	585.5	598	610.5	623	623	635.5	648	660.5	673	685.5	698	698
8	560.5	573	585.5	598	598	610.5	623	635.5	648	660.5	660.5	673	685.5	698	710.5	723	723	735.5	748
9	610.5	623	623	635.5	648	660.5	673	685.5	685.5	698	710.5	723	735.5	748	760.5	760.5	773	785.5	798

**Dimensions: Series 10-SV1000**

**Power supply with 7/8 inch connector**

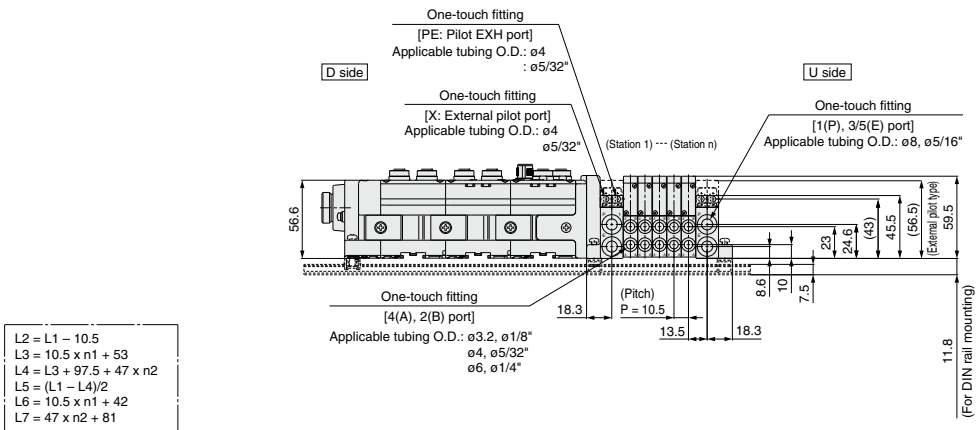
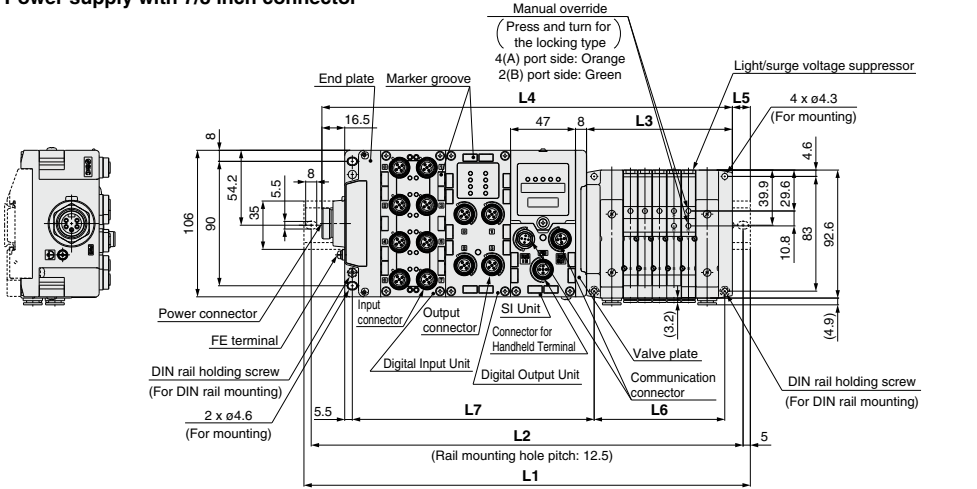

**L1: DIN Rail Overall Length**

I/O Unit stations (n2)	Valve stations (n1)	2	3	4	5	6	7	8	9	10	11	12	13	14	15	16	17	18	19	20		
0	198	210.5	223	235.5	248	248	260.5	273	285.5	298	310.5	323	335.5	348	360.5	373	385.5	398	410.5	423	435.5	
1	248	260.5	273	285.5	298	298	310.5	323	335.5	348	360.5	373	385.5	398	410.5	423	435.5	448	460.5	473	485.5	
2	298	310.5	310.5	323	335.5	348	360.5	373	373	385.5	398	410.5	423	435.5	448	460.5	473	485.5	498	510.5	523	535.5
3	348	348	360.5	373	385.5	398	410.5	410.5	423	435.5	448	460.5	473	473	485.5	498	510.5	523	535.5	548	560.5	573
4	385.5	398	410.5	423	435.5	448	460.5	473	485.5	498	510.5	523	535.5	548	560.5	573	585.5	598	610.5	623	635.5	648
5	435.5	448	460.5	473	473	485.5	498	510.5	523	535.5	548	560.5	573	585.5	598	610.5	623	635.5	648	660.5	673	685.5
6	485.5	498	498	510.5	523	535.5	548	560.5	573	573	585.5	598	610.5	623	635.5	648	660.5	673	685.5	698	710.5	723
7	535.5	535.5	548	560.5	573	585.5	598	610.5	623	635.5	648	660.5	673	685.5	698	710.5	723	735.5	748	760.5	773	785.5
8	573	585.5	598	610.5	623	635.5	648	660.5	673	685.5	698	710.5	723	735.5	748	760.5	773	785.5	798	810.5	823	835.5
9	623	635.5	648	660.5	673	685.5	698	710.5	723	735.5	748	760.5	773	785.5	798	810.5	823	835.5	848	860.5	873	885.5

Directional Control Valves  
 Air Cylinders  
 Rotary Actuators  
 Air Grippers  
 Air Preparation Equipment  
 Modular F. R.  
 Pressure Control Equipment  
 Fittings & Tubing  
 Flow Control Equipment  
 Pressure Switches/ Pressure Sensors

**Dimensions: Series 10-SV2000**

**Power supply with M12 connector**

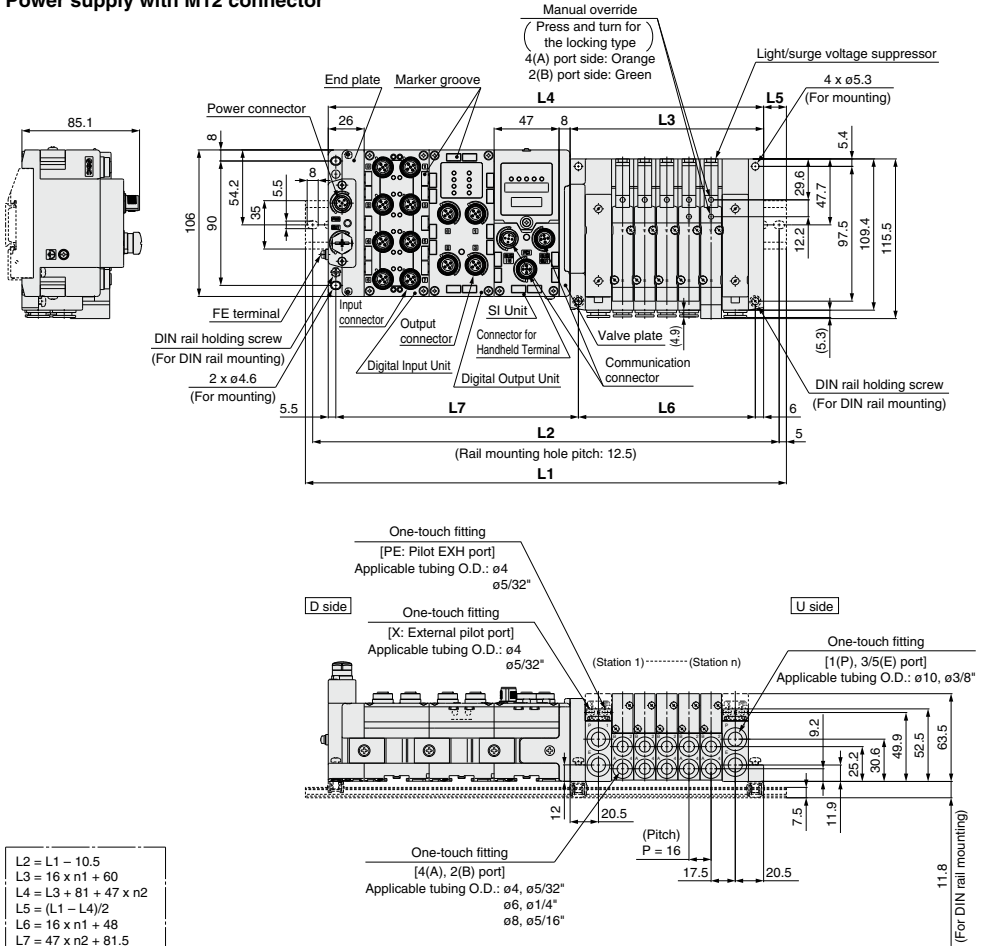

**L1: DIN Rail Overall Length**

I/O Unit stations (n2) \ Valve stations (n1)	2	3	4	5	6	7	8	9	10	11	12	13	14	15	16	17	18	19	20
0	198	223	235.5	248	260.5	285.5	298	310.5	335.5	348	360.5	373	398	410.5	423	448	460.5	473	485.5
1	248	260.5	285.5	298	310.5	335.5	348	360.5	373	398	410.5	423	435.5	460.5	473	485.5	510.5	523	535.5
2	298	310.5	323	348	360.5	373	398	410.5	423	435.5	460.5	473	485.5	510.5	523	535.5	548	573	585.5
3	348	360.5	373	385.5	410.5	423	435.5	460.5	473	485.5	498	523	535.5	548	573	585.5	598	610.5	635.5
4	385.5	410.5	423	435.5	460.5	473	485.5	498	523	535.5	548	560.5	585.5	598	610.5	635.5	648	660.5	673
5	435.5	448	473	485.5	498	523	535.5	548	560.5	585.5	598	610.5	635.5	648	660.5	673	698	710.5	723
6	485.5	498	510.5	535.5	548	560.5	585.5	598	610.5	623	648	660.5	673	698	710.5	723	735.5	760.5	773
7	535.5	548	560.5	585.5	598	610.5	623	648	660.5	673	685.5	710.5	723	735.5	760.5	773	785.5	798	823
8	573	598	610.5	623	648	660.5	673	685.5	710.5	723	735.5	760.5	773	785.5	798	823	835.5	848	860.5
9	623	635.5	660.5	673	685.5	710.5	723	735.5	748	773	785.5	798	823	835.5	848	860.5	885.5	898	910.5



**Dimensions: Series 10-SV3000**

**Power supply with M12 connector**

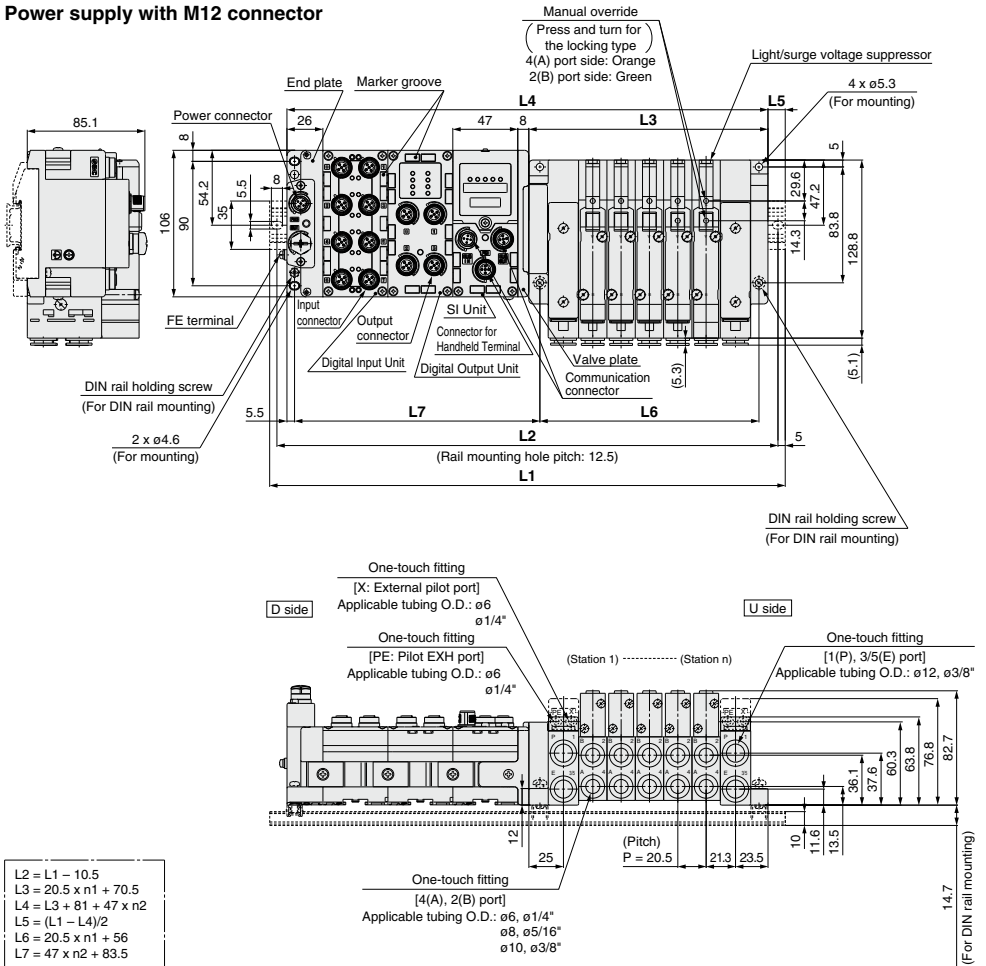

**L1: DIN Rail Overall Length**

I/O Unit stations (n2) \ Valve stations (n1)	2	3	4	5	6	7	8	9	10	11	12	13	14	15	16	17	18	19	20
0	223	248	260.5	285.5	298	323	348	360.5	385.5	410.5	423	448	473	485.5	510.5	535.5	548	573	585.5
1	273	285.5	310.5	335.5	348	373	398	410.5	435.5	448	473	498	510.5	535.5	560.5	573	598	623	635.5
2	310.5	335.5	360.5	373	398	423	435.5	460.5	485.5	498	523	535.5	560.5	585.5	598	623	648	660.5	685.5
3	360.5	385.5	398	423	448	460.5	485.5	510.5	523	548	573	585.5	610.5	635.5	648	673	685.5	710.5	735.5
4	410.5	435.5	448	473	498	510.5	535.5	548	573	598	610.5	635.5	660.5	673	698	723	735.5	760.5	773
5	460.5	473	498	523	535.5	560.5	585.5	598	623	635.5	660.5	685.5	698	723	748	760.5	785.5	810.5	823
6	498	523	548	560.5	585.5	610.5	623	648	673	685.5	710.5	735.5	748	773	785.5	810.5	835.5	848	873
7	548	573	598	610.5	635.5	648	673	698	710.5	735.5	760.5	773	798	823	835.5	860.5	873	898	923
8	598	623	635.5	660.5	685.5	698	723	735.5	760.5	785.5	798	823	848	860.5	885.5	910.5	923	948	973
9	648	660.5	685.5	710.5	723	748	773	785.5	810.5	835.5	848	873	885.5	910.5	935.5	948	973	—	—

**Dimensions: Series 10-SV3000**

**Power supply with 7/8 inch connector**

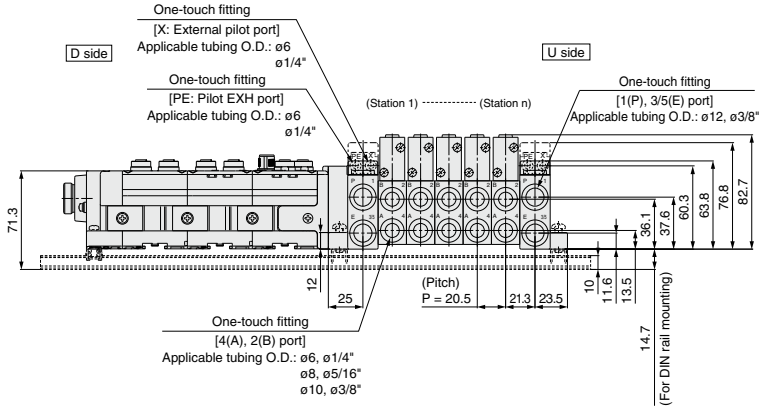
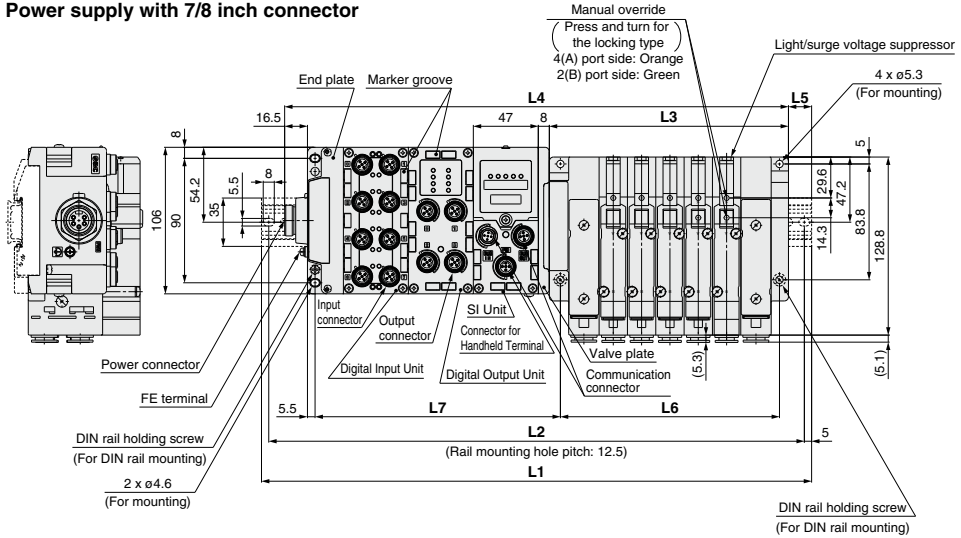

- L2 = L1 - 10.5
- L3 = 20.5 x n1 + 70.5
- L4 = L3 + 97.5 + 47 x n2
- L5 = (L1 - L4)/2
- L6 = 20.5 x n1 + 56
- L7 = 47 x n2 + 83.5

**L1: DIN Rail Overall Length**

I/O Unit stations (n2) \ Valve stations (n1)	2	3	4	5	6	7	8	9	10	11	12	13	14	15	16	17	18	19	20
0	235.5	260.5	285.5	298	323	335.5	360.5	385.5	398	423	448	460.5	485.5	510.5	523	548	560.5	585.5	610.5
1	285.5	310.5	323	348	373	385.5	410.5	423	448	473	485.5	510.5	535.5	548	573	598	610.5	635.5	660.5
2	335.5	348	373	398	410.5	435.5	460.5	473	498	523	535.5	560.5	573	598	623	635.5	660.5	685.5	698
3	385.5	398	423	435.5	460.5	485.5	498	523	548	560.5	585.5	610.5	623	648	660.5	685.5	710.5	723	748
4	423	448	473	485.5	510.5	523	548	573	585.5	610.5	635.5	648	673	698	710.5	735.5	760.5	773	798
5	473	498	510.5	535.5	560.5	573	598	623	635.5	660.5	673	698	723	735.5	760.5	785.5	798	823	848
6	523	535.5	560.5	585.5	598	623	648	660.5	685.5	710.5	723	748	760.5	785.5	810.5	823	848	873	885.5
7	573	585.5	610.5	623	648	673	685.5	710.5	735.5	748	773	798	810.5	835.5	860.5	873	898	910.5	935.5
8	610.5	635.5	660.5	673	698	723	735.5	760.5	773	798	823	835.5	860.5	885.5	898	923	948	960.5	985.5
9	660.5	685.5	698	723	748	760.5	785.5	810.5	823	848	860.5	885.5	910.5	923	948	973	985.5	—	—

Directional Control Valves  
 Air Cylinders  
 Rotary Actuators  
 Air Grippers  
 Air Preparation Equipment  
 Modular F. R.  
 Pressure Control Equipment  
 Fittings & Tubing  
 Flow Control Equipment  
 Pressure Switches/ Pressure Sensors



# Dedicated Output Serial Wiring

## Series EX120

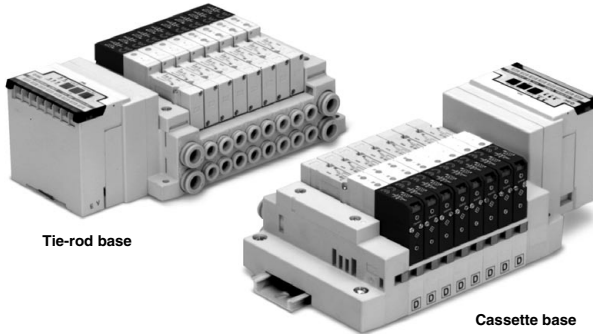

Applicable series	Cassette base manifold <b>10-SV1000/10-SV2000</b>
	Tie-rod base manifold <b>10-SV1000/10-SV2000/10-SV3000/10-SV4000</b>
· Number of outputs: 16	

Directional Control Valves

Air Cylinders

Rotary Actuators

Air Grippers

Air Preparation Equipment

Modular F. R.

Pressure Control Equipment

Fittings & Tubing

Flow Control Equipment

Pressure Switches/ Pressure Sensors



# Series 10-SV

EX120 Dedicated Output Serial Wiring



## How to Order

**Tie-rod base**  
**10 - SS5V 1 - 10S3 V D - 05 U**

**Cassette base**  
**10 - SS5V 1 - 16S3 V D - 05 U**

**Clean series**  
 Series:  
 1 10-SV1000  
 2 10-SV2000

**SI unit**  
 Symbol Protocol type  
**0** Without SI unit  
**Q** DeviceNet®  
**V** CC-Link  
**ZB** CompoNet® (Positive common)  
**ZBN** CompoNet® (Negative common)  
 Note) Communication connector (for the opposite side) is not provided, order it separately.

**SI Unit Part No.**  
 Symbol Protocol type SI unit part no.  
**Q** DeviceNet® EX120-SDN1  
**V** CC-LINK EX120-SMJ1  
**ZB** CompoNet® (Positive common) EX120-SCM1  
**ZBN** CompoNet® (Negative common) EX120-SCM3  
 Refer to the **Web Catalog** and the Operation Manual for the details of EX120 Integrated-type (For Output) Serial Transmission System. Please download the Operation Manual via our website, <https://www.smcworld.com>.

**Series**  
 1 10-SV1000  
 2 10-SV2000  
 3 10-SV3000  
 4 10-SV4000

**Valve stations**  
 Symbol Stations Note  
**02** 2 stations Double wiring (Note 1)  
 : :  
**08** 8 stations  
**02** 2 stations Specified layout (Note 2) (up to 16 solenoids possible)  
 : :  
**16** 16 stations

Note 1) Double wiring: Single, double, 3 position and 4 position solenoid valves can be used on all manifold stations. Use of a single solenoid will result in an unused control signal. If this is not desired, order with a specified layout.  
 Note 2) Specified layout: Indicate wiring specifications on the manifold specification sheet. (Note that double, 3 position and 4 position valves cannot be used where single solenoid wiring has been specified.)

**Mounting**  
 Nil Direct mounting  
**D** DIN rail mounting (With DIN rail)  
**D0** DIN rail mounting (Without DIN rail)  
**D3** For 3 stations When a longer DIN rail is chosen than the specifications (Specify a longer rail than the standard length.)  
 : :  
**D16** For 16 stations (Specify a longer rail than the standard length.)  
 Note) For D0, only DIN rail mounting bracket is attached.

**DIN rail length specified**  
 Nil Standard length  
**3** For 3 stations Specify a longer rail than the standard length.  
 : :  
**16** For 16 stations

**SUP/EXH block assembly**  
 Nil Internal pilot  
**R** External pilot

**P, E port location**  
**U** U side (2 to 10 stations)  
**D** D side (2 to 10 stations)  
**B** Both sides (2 to 16 stations)

### A, B port size (Metric)

Symbol	A, B port	P, E port	Applicable series
<b>C3</b>	ø3.2 One-touch fitting	ø8 One-touch fitting	<b>10-SV1000</b>
<b>C4</b>	ø4 One-touch fitting		
<b>C6</b>	ø6 One-touch fitting	ø10 One-touch fitting	<b>10-SV2000</b>
<b>C4</b>	ø4 One-touch fitting		
<b>C6</b>	ø6 One-touch fitting	ø12 One-touch fitting	<b>10-SV3000</b>
<b>C8</b>	ø8 One-touch fitting		
<b>C8</b>	ø8 One-touch fitting	ø12 One-touch fitting	<b>10-SV4000</b>
<b>C10</b>	ø10 One-touch fitting		
<b>C12</b>	ø12 One-touch fitting	Rc 3/8	
<b>02</b>	Rc 1/4		
<b>03</b>	Rc 3/8	G 3/8	
<b>02F</b>	G 1/4		
<b>03F</b>	G 3/8		
<b>M</b>	Mixed		

### A, B port size (Inch)

Symbol	A, B port	P, E port	Applicable series
<b>N1</b>	ø1/8" One-touch fitting	ø5/16" One-touch fitting	<b>10-SV1000</b>
<b>N3</b>	ø5/32" One-touch fitting		
<b>N7</b>	ø1/4" One-touch fitting	ø3/8" One-touch fitting	<b>10-SV2000</b>
<b>N3</b>	ø5/32" One-touch fitting		
<b>N7</b>	ø1/4" One-touch fitting	ø3/8" One-touch fitting	<b>10-SV3000</b>
<b>N9</b>	ø5/16" One-touch fitting		
<b>N7</b>	ø1/4" One-touch fitting	ø3/8" One-touch fitting	<b>10-SV4000</b>
<b>N9</b>	ø5/16" One-touch fitting		
<b>N11</b>	ø3/8" One-touch fitting	NPT 3/8	
<b>N9</b>	ø5/16" One-touch fitting		
<b>N11</b>	ø3/8" One-touch fitting	NPTF 3/8	
<b>02N</b>	NPT 1/4		
<b>03N</b>	NPT 3/8		
<b>02T</b>	NPTF 1/4		
<b>03T</b>	NPTF 3/8		
<b>M</b>	Mixed		

\* For mixed specifications (M), indicate separately on the manifold specification sheet.

\* External pilot type (R) X, PE port sizes are ø4 (metric), ø5/32" (inch) for the 10-SV1000/2000 series and ø6 (metric), ø1/4" (inch) for the 10-SV3000/4000 series.

## How to Order Valve Manifold Assembly

### Ordering example (10-SV1000)

Manifold

10-SS5V1-16S3VD-06B-C6 (1 set)

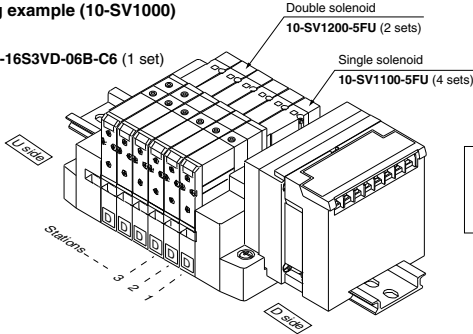

10-SS5V1-16S3VD-06B-C6.....1 set (Manifold part no.)  
 \* 10-SV1100-5FU.....4 sets (Single solenoid part no.)  
 \* 10-SV1200-5FU.....2 sets (Double solenoid part no.)

## How to Order Solenoid Valve

**10 - SV** 1 1 00     - **5** **F**     -   -   (Note)

**Clean series** •

1	10-SV1000
2	10-SV2000
3	10-SV3000
4	10-SV4000

**Series** •

1	10-SV1000
2	10-SV2000
3	10-SV3000
4	10-SV4000

**Actuation type** •

1	2 position single solenoid
2	2 position double solenoid
3	3 position closed center
4	3 position exhaust center
5	3 position pressure center
A	4 position dual 3 port valve: N.C./N.C.
B	4 position dual 3 port valve: N.O./N.O.
C	4 position dual 3 port valve: N.C./N.O.

\* 4 position dual 3 port valves are applicable to the 10-SV1000 and 10-SV2000 series only.

**Pilot type** •

Nil	Internal pilot
R	External pilot

\* External pilot specifications are not available for 4 position dual 3 port valves.

**Back pressure check valve** •

Nil	None
K	Built-in

\* The built-in back pressure check valve type is applicable to the 10-SV1000 series only.  
 \* The product with back pressure check valve is not available for 3 position solenoid valves.

**Rated voltage** •

5	24 VDC
---	--------

**Manual override**

Nil: Non-locking push type	D: Push-turn locking slotted type
----------------------------	-----------------------------------

**Light/surge voltage suppressor**

U	With light/surge voltage suppressor
R	With surge voltage suppressor

**Made to Order** •

Nil	—
X90	Main valve fluororubber (Refer to page 272.)

Note) Available with manifold block for station additions. Refer to the **WEB catalog**.

Note) Refer to the Specific Product Precautions 2 on page 274.

Directional Control Valves  
 Air Cylinders  
 Rotary Actuators  
 Air Grippers  
 Air Preparation Equipment  
 Modular F. R.  
 Pressure Control Equipment  
 Fittings & Tubing  
 Flow Control Equipment  
 Pressure Switches/ Pressure Sensors

## Dimensions: Series 10-SV1000 for EX120 Dedicated Output Serial Wiring

- **Cassette base manifold: 10-SS5V1-16S3□D- Stations** U  
D (R)  
B C3, N1  
C4, N3  
C6, N7

•When P, E port outlets are indicated on the U side or D side, the P, E ports on the opposite side are plugged.  
 •External pilot port positions are the same as P, E port outlet positions.

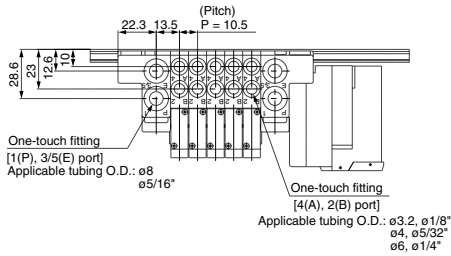

### With external pilot specifications

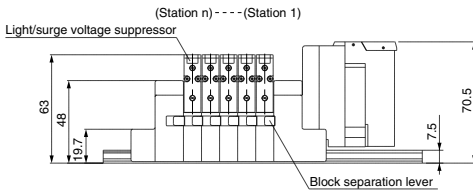
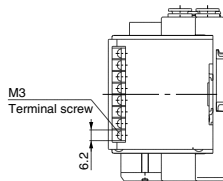
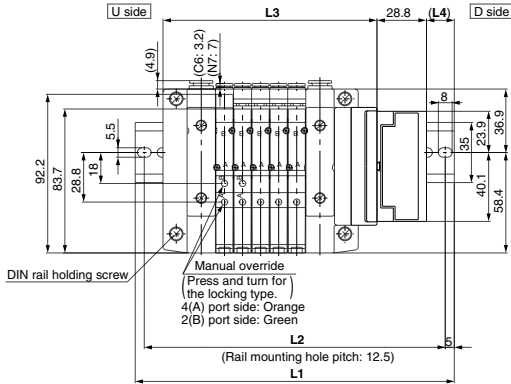
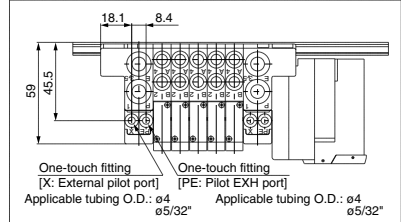

### With option

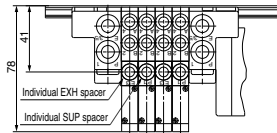

### L Dimension

L <sup>n</sup>	n: Stations															
	2	3	4	5	6	7	8	9	10	11	12	13	14	15	16	
L1	148	160.5	173	185.5	198	198	210.5	223	235.5	248	260.5	260.5	273	285.5	298	
L2	137.5	150	162.5	175	187.5	187.5	200	212.5	225	237.5	250	250	262.5	275	287.5	
L3	92.9	103.4	113.9	124.4	134.9	145.4	155.9	166.4	176.9	187.4	197.9	208.4	218.9	229.4	239.9	
L4	13	14	15	16	17	12	13	14	15	16	17	11.5	12.5	13.5	14.5	

## Dimensions: Series 10-SV2000 for EX120 Dedicated Output Serial Wiring

- **Cassette base manifold: 10-SS5V2-16S3□D-(Stations) U D (R)** C4, N3  
C6, N7  
C8, N9

•When P, E port outlets are indicated on the U side or D side, the P, E ports on the opposite side are plugged.  
•External pilot port positions are the same as P, E port outlet positions.

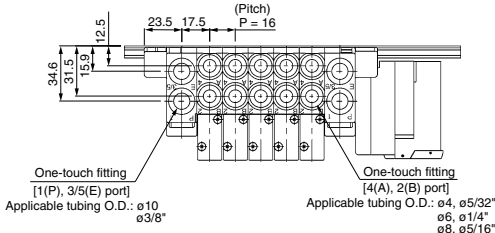

With external pilot specifications

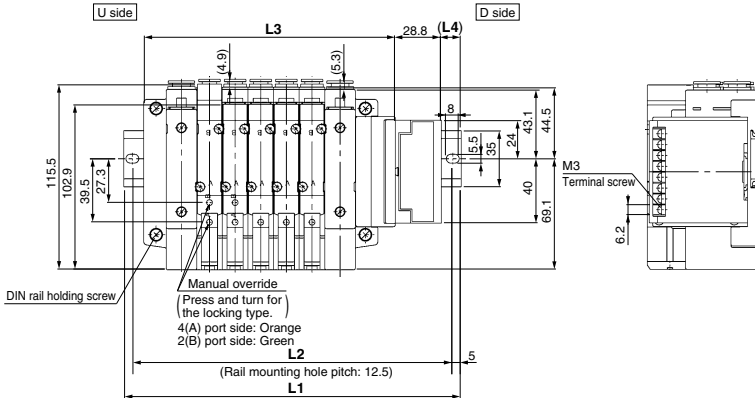
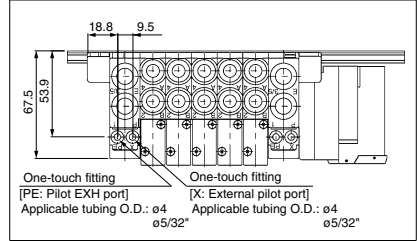

With option

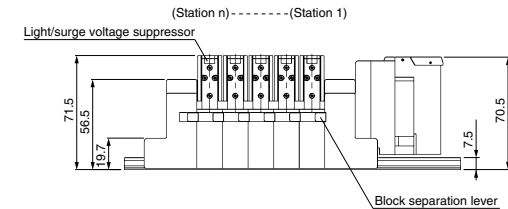

### L Dimension

L	n	2	3	4	5	6	7	8	9	10	11	12	13	14	15	16
L1		173	185.5	198	210.5	235.5	248	260.5	273	298	310.5	323	348	360.5	373	385.5
L2		162.5	175	187.5	200	225	237.5	250	262.5	287.5	300	312.5	337.5	350	362.5	375
L3		108.9	124.9	140.9	156.9	172.9	188.9	204.9	220.9	236.9	252.9	268.9	284.9	300.9	316.9	332.9
L4		17.5	16	14	12.5	17	15	13.5	11.5	16	14.5	12.5	17	15.5	13.5	12

n: Stations

Directional Control Valves

Air Cylinders

Rotary Actuators

Air Grippers

Air Preparation Equipment

Modular F. R.

Pressure Control Equipment

Fittings & Tubing

Flow Control Equipment

Pressure Switches/ Pressure Sensors

**Dimensions: Series 10-SV1000 for EX120 Dedicated Output Serial Wiring**

- Tie-rod base manifold: 10-SS5V1-10S3□D-(Stations)  $\frac{U}{B}$  (R) -  $\begin{matrix} C3, N1 \\ C4, N3 \\ C6, N7 \end{matrix}$  (D)

•When P, E port outlets are indicated on the U side or D side, the P, E ports on the opposite side are plugged.  
 •External pilot port positions are the same as P, E port outlet positions.

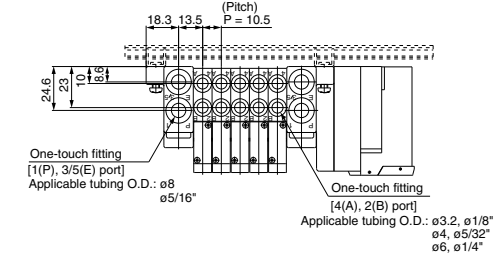

**With external pilot specifications**

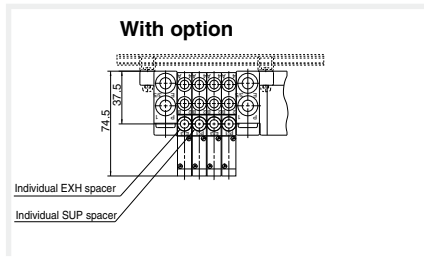
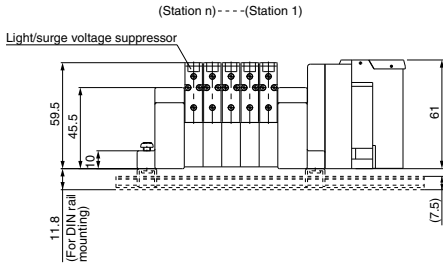
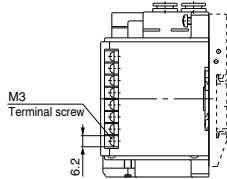
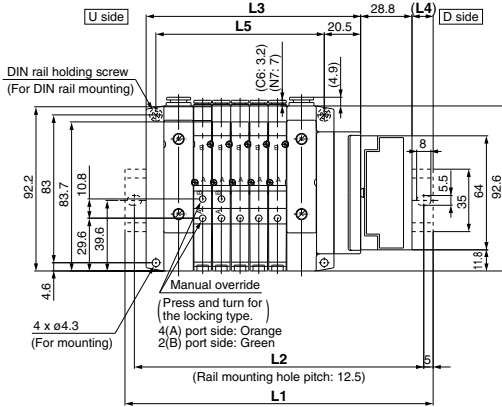
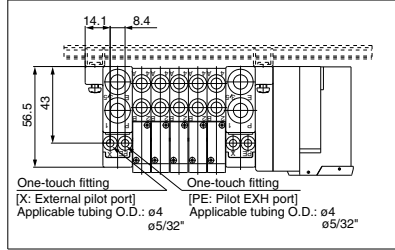

**L Dimension**

n: Stations

L <sub>n</sub>	2	3	4	5	6	7	8	9	10	11	12	13	14	15	16
L1	148	160.5	173	173	185.5	198	210.5	223	235.5	235.5	248	260.5	273	285.5	298
L2	137.5	150	162.5	162.5	175	187.5	200	212.5	225	225	237.5	250	262.5	275	287.5
L3	89	99.5	110	120.5	131	141.5	152	162.5	173	183.5	194	204.5	215	225.5	236
L4	15	16	17	12	13	14	15	16	17	11.5	12.5	13.5	14.5	15.5	16.5
L5	63	73.5	84	94.5	105	115.5	126	136.5	147	157.5	168	178.5	189	199.5	210

## Dimensions: Series 10-SV2000 for EX120 Dedicated Output Serial Wiring

• Tie-rod base manifold: 10-SS5V2-10S3□D-**Stations**  $\begin{matrix} U \\ D \end{matrix}$  (R)  $\begin{matrix} C4, N3 \\ C6, N7 \\ C8, N9 \end{matrix}$  (-D)

- When P, E port outlets are indicated on the U side or D side, the P, E ports on the opposite side are plugged.
- External pilot port positions are the same as P, E port outlet positions.

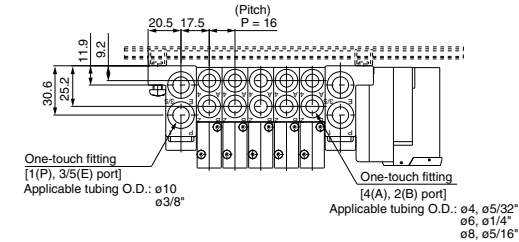

With external pilot specifications

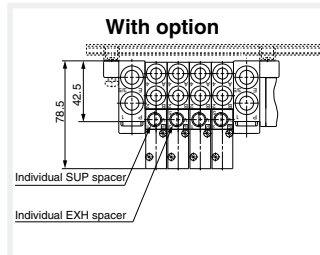
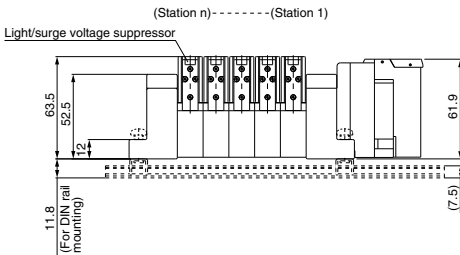
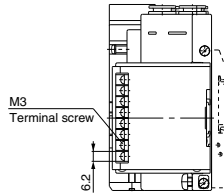
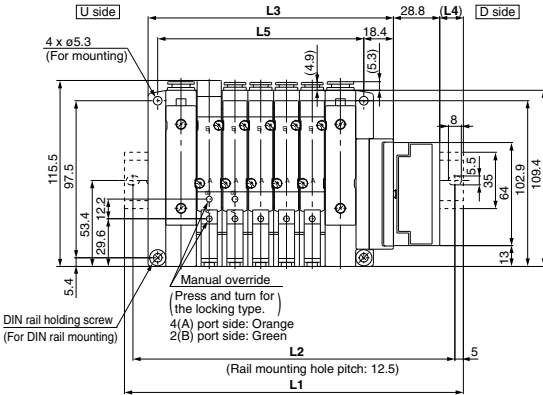
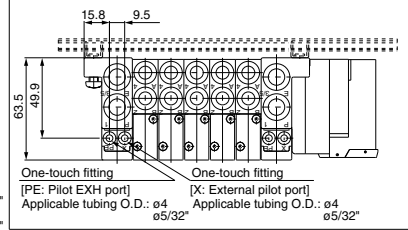

**L Dimension**

L	n	2	3	4	5	6	7	8	9	10	11	12	13	14	15	16
L1	n: Stations	160.5	173	198	210.5	223	248	260.5	273	285.5	310.5	323	335.5	360.5	373	385.5
L2		150	162.5	187.5	200	212.5	237.5	250	262.5	275	300	312.5	325	350	362.5	375
L3		104.4	120.4	136.4	152.4	168.4	184.4	200.4	216.4	232.4	248.4	264.4	280.4	296.4	312.4	328.4
L4		13.5	12	16.5	14.5	13	17.5	15.5	14	12	16.5	15	13	17.5	16	14
L5		80	96	112	128	144	160	176	192	208	224	240	256	272	288	304

Directional Control Valves

Air Cylinders

Rotary Actuators

Air Grippers

Air Preparation Equipment

Modular F. R.

Pressure Control Equipment

Fittings & Tubing

Flow Control Equipment

Pressure Switches/ Pressure Sensors



## Dimensions: Series 10-SV4000 for EX120 Dedicated Output Serial Wiring

- Tie-rod base manifold: 10-SS5V4-10S3□D-**Stations**  $\begin{matrix} U \\ D \end{matrix}$  (R)  $\begin{matrix} \text{C8, N9} \\ \text{C10, N11} \end{matrix}$  (-D)

•When P, E port outlets are indicated on the U side or D side, the P, E ports on the opposite side are plugged.  
 •External pilot port positions are the same as P, E port outlet positions.

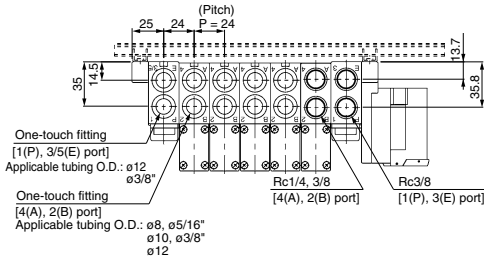

With external pilot specifications

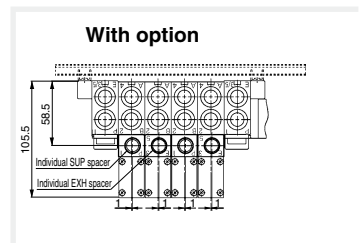
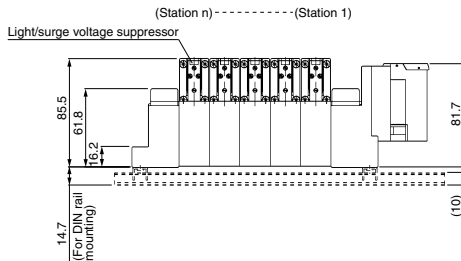
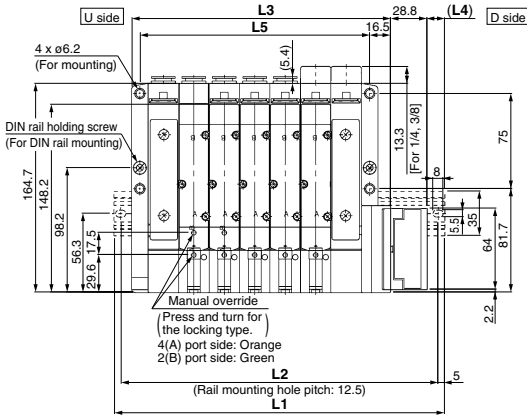
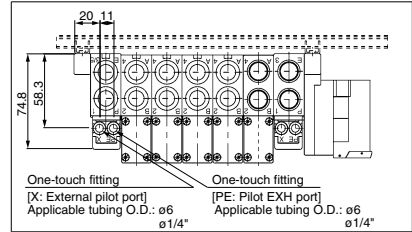

### L Dimension

n	2	3	4	5	6	7	8	9	10	11	12	13	14	15	16
L1	185.5	210.5	235.5	260.5	285.5	310.5	335.5	360.5	385.5	410.5	435.5	448	473	498	523
L2	175	200	225	250	275	300	325	350	375	400	425	437.5	462.5	487.5	512.5
L3	132	156	180	204	228	252	276	300	324	348	372	396	420	444	468
L4	12.5	13	13.5	14	14.5	15	15.5	16	16.5	17	17.5	11.5	12	12.5	13
L5	109	133	157	181	205	229	253	277	301	325	349	373	397	421	445

n: Stations

Directional Control Valves

Air Cylinders

Rotary Actuators

Air Grippers

Air Preparation Equipment

Modular F. R.

Pressure Control Equipment

Fittings & Tubing

Flow Control Equipment

Pressure Switches/ Pressure Sensors





# Integrated Type (For Output) Serial Transmission System

## Series **EX260** IP67 compliant (Some products are IP40)

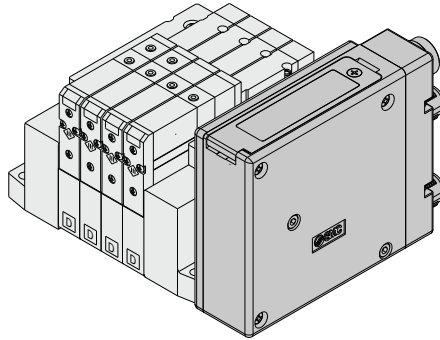

Tie-rod base

Applicable series	Tie-rod base manifold 10-SV1000/10-SV2000/10-SV3000
	· Number of outputs: 16, 32

Directional  
Control Valves

Air Cylinders

Rotary Actuators

Air Grippers

Air Preparation  
Equipment

Modular F. R.

Pressure Control  
Equipment

Fittings & Tubing

Flow Control  
Equipment

Pressure Switches/  
Pressure Sensors



### How to Order Manifold

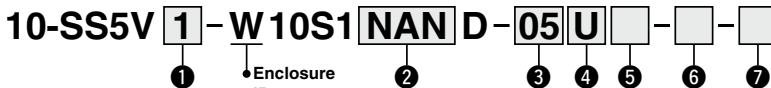

① Enclosure IP67  
 \* Refer to Note 3) of the ② SI unit specifications.

#### ① Series

1	10-SV1000
2	10-SV2000
3	10-SV3000

#### ② SI unit specifications

(Output polarity, protocol, number of outputs, communication connector)

Symbol (output polarity)		Protocol	Number of outputs	Communication connector
Positive common (NPN)	Negative common (PNP)			
0 Without SI unit				
QA	QAN	DeviceNet®	32	M12
QB	QBN		16	
NA	NAN		32	
NB	NBN		16	
NC	NCN	PROFIBUS DP	32	M12
ND	NDN		16	
VA	VAN	CC-Link	32	M12
VB	VBN		16	
DA	DAN	EtherCAT	32	M12
DB	DBN		16	
FA	FAN	PROFINET	32	M12
FB	FBN		16	
EA	EAN	EtherNet/IP™	32	M12
EB	EBN		16	
— Note 2)		Ethernet	32	M12
— Note 2)			POWERLINK	

Note 1) DIN rail cannot be mounted without SI unit.  
 Note 2) Positive common (NPN) type is not applicable.  
 Note 3) IP40 for the D-sub applicable communication connector specification. (The manifold part number is "10-SS5V□-10S1NC/ND□D".)  
 Note 4) For SI unit part number, refer to the table below.

#### ⑥ A, B port size (Metric)

Symbol	A, B port	P, E port	Applicable series
C3	ø3.2 One-touch fitting	ø8 One-touch fitting	10-SV1000
C4	ø4 One-touch fitting		
C6	ø6 One-touch fitting		
C4	ø4 One-touch fitting	ø10 One-touch fitting	10-SV2000
C6	ø6 One-touch fitting		
C8	ø8 One-touch fitting		
C6	ø6 One-touch fitting	ø12 One-touch fitting	10-SV3000
C8	ø8 One-touch fitting		
C10	ø10 One-touch fitting		
M	Mixed		

\* For mixed specifications (M), indicate separately on the manifold specification sheet.  
 \* External pilot type (R) X, PE port sizes are ø4 (mm) or ø5/32" (inch) for the 10-SV1000/2000 series, and ø6 (mm) or ø1/4" (inch) for the 10-SV3000 series.

#### EX260 SI unit part no.

Symbol	Protocol	Number of outputs	Communication connector	SI unit part no.	
				+COM.	-COM.
QA	DeviceNet®	32	M12	EX260-SDN2	EX260-SDN1
QB		16		EX260-SDN4	EX260-SDN3
NA	PROFIBUS DP	32	M12	EX260-SPR2	EX260-SPR1
NB		16		EX260-SPR4	EX260-SPR3
NC		32		EX260-SPR6	EX260-SPR5
ND		16		EX260-SPR8	EX260-SPR7
VA	CC-Link	32	M12	EX260-SMJ2	EX260-SMJ1
VB		16		EX260-SMJ4	EX260-SMJ3

#### ③ Valve stations

For 32-output SI unit

Symbol	Stations	Note
02	2 stations	Double wiring Note 1)
⋮	⋮	
16	16 stations	
02	2 stations	Specified layout Note 2) (Available up to 32 solenoids)
⋮	⋮	
20	20 stations	

For 16-output SI unit

Symbol	Stations	Note
02	2 stations	Double wiring Note 1)
⋮	⋮	
08	8 stations	
02	2 stations	Specified layout Note 2) (Available up to 16 solenoids)
⋮	⋮	
16	16 stations	

Note 1) Double wiring: Single, double, 3-position and 4-position solenoid valves can be used on all manifold stations. Use of a single solenoid will result in an unused control signal. If this is not desired, order with a specified layout.  
 Note 2) Specified layout: Indicate the wiring specifications on the manifold specification sheet.  
 (Note that double, 3-position and 4-position valves cannot be used where single solenoid wiring has been specified.)

#### ④ P, E port location

U	U side (2 to 10 stations)
D	D side (2 to 10 stations)
B	Both sides (2 to 20 stations)

#### ⑤ SUP/EXH block assembly

NII	Internal pilot
R	External pilot

#### ⑦ Mounting

NII	Direct mounting
D	DIN rail mounting (With DIN rail)
D0	DIN rail mounting (Without DIN rail)
D3	For 3 stations When a longer DIN rail is desired than the specified stations.
⋮	⋮ (Specify a longer rail than the standard length.)
D20	For 20 stations

\* If the DIN rail must be mounted without SI unit, select "D0" and order the DIN rail separately. Refer to L3 of the dimensions for the DIN rail length. For the DIN rail part number, refer to the WEB catalog or SV series catalog (CAT.ES11-81).

#### A, B port size (Inch)

Symbol	A, B port	P, E port	Applicable series
N1	ø1/8" One-touch fitting	ø5/16" One-touch fitting	10-SV1000
N3	ø5/32" One-touch fitting		
N7	ø1/4" One-touch fitting		
N3	ø5/32" One-touch fitting	ø3/8" One-touch fitting	10-SV2000
N7	ø1/4" One-touch fitting		
N9	ø5/16" One-touch fitting		
N7	ø1/4" One-touch fitting	ø3/8" One-touch fitting	10-SV3000
N9	ø5/16" One-touch fitting		
N11	ø3/8" One-touch fitting		
M	Mixed		

#### EX260 SI unit part no.

Symbol	Protocol	Number of outputs	Communication connector	SI unit part no.	
				+COM.	-COM.
DA	EtherCAT	32	M12	EX260-SEC2	EX260-SEC1
DB		16		EX260-SEC4	EX260-SEC3
FA	PROFINET	32	M12	EX260-SPN2	EX260-SPN1
FB		16		EX260-SPN4	EX260-SPN3
EA	EtherNet/IP™	32	M12	EX260-SEN2	EX260-SEN1
EB		16		EX260-SEN4	EX260-SEN3
GA	Ethernet POWERLINK	32	M12	—	EX260-SPL1
GB		16		—	EX260-SPL3

## How to Order Manifold Assembly

### Example (10-SV1000)

Manifold  
10-SS5V1-W10S1NAND-04B-C6 (1 set)

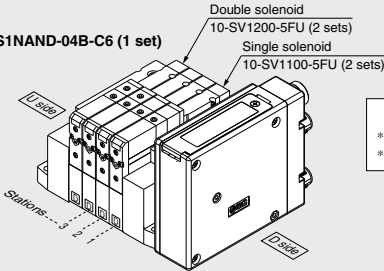

10-SS5V1-W10S1NAND-04B-C6.....1 set (Manifold part no.)  
\*10-SV1100-5FU.....2 sets (Single solenoid part no.)  
\*10-SV1200-5FU.....2 sets (Double solenoid part no.)

## How to Order Valve

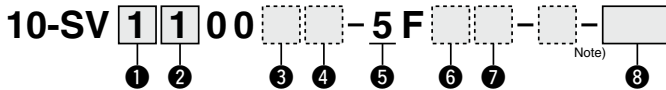

### 1 Series

1	10-SV1000
2	10-SV2000
3	10-SV3000

### 2 Actuation type

1	2-position single
2	2-position double
3	3-position closed center
4	3-position exhaust center
5	3-position pressure center
A	4-position dual 3-port valve: N.C./N.C.
B	4-position dual 3-port valve: N.O./N.O.
C	4-position dual 3-port valve: N.C./N.O.

\* 4-position dual 3-port valves are applicable to the 10-SV1000/2000 series only.

### 3 Pilot type

NII	Internal pilot
R	External pilot

\* External pilot specifications are not available for 4-position dual 3-port valves.

### 4 Back pressure check valve

NII	None
K	Built-in

\* The built-in back pressure check valve type is applicable to the 10-SV1000 series only.  
\* The product with back pressure check valve is not available for 3-position valves.

Note) Refer to the Specific Product Precautions 2 in the Best Pneumatics No. 1.

### 5 Rated voltage

5	24 VDC
---	--------

### 6 Light/surge voltage suppressor

U	With light/surge voltage suppressor
R	With surge voltage suppressor

### 7 Manual override

NII: Non-locking push type

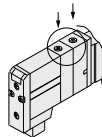

D: Push-turn locking slotted type

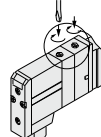

Note) Available with manifold block for station additions. Refer to the **WEB catalog**.

### 8 Made to Order

NII	—
X90	Main valve fluororubber (Refer to page 272.)

Refer to the SMC website or the SV series in the Best Pneumatics No. 1 for details on solenoid valve specifications, Common Precautions and Specific Product Precautions.

**Dimensions: Series 10-SV1000 for EX260 Integrated-type (For Output) Serial Transmission System**

● Tie-rod base manifold: 10-SS5V1-W10S1 □□D- Stations  $\frac{U}{D}$  (R)- C3, N1  
C4, N3 C6, N7 (-D)

- When P, E port outlets are indicated on the U side or D side, the P, E ports on the opposite side are plugged.
- External pilot port positions are the same as P, E port outlet positions.

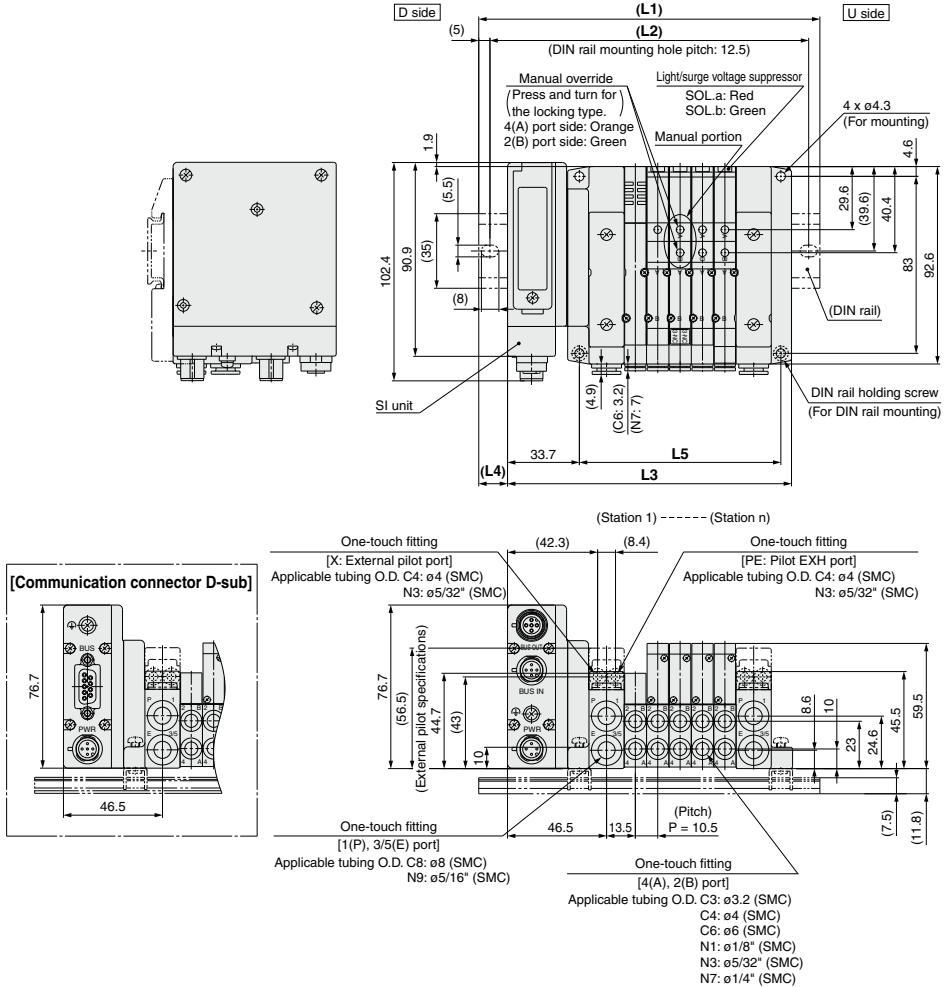

**L: DIN Rail Overall Length**

L	n: Stations																			
	2	3	4	5	6	7	8	9	10	11	12	13	14	15	16	17	18	19	20	
L1	135.5	148	148	160.5	173	185.5	198	210.5	210.5	223	235.5	248	260.5	273	273	285.5	298	310.5	323	
L2	125	137.5	137.5	150	162.5	175	187.5	197.5	200	212.5	225	237.5	250	262.5	262.5	275	287.5	300	312.5	
L3	102.2	112.7	123.2	133.7	144.2	154.7	165.2	175.7	186.2	196.7	207.2	217.7	228.2	238.7	249.2	259.7	270.2	280.7	291.2	
L4	16.5	17.5	12.5	13.5	14.5	15.5	16.5	17.5	12	13	14	15	16	17	12	13	14	15	16	
L5	63	73.5	84	94.5	105	115.5	126	136.5	147	157.5	168	178.5	189	199.5	210	220.5	231	241.5	252	

**Dimensions: Series 10-SV2000 for EX260 Integrated-type (For Output) Serial Transmission System**

● Tie-rod base manifold: 10-SS5V2-W10S1 □ □ D - Stations  $\begin{matrix} U \\ D \end{matrix}$  (R)- C4, N3  
C6, N7  
C8, N9 (-D)

- When P, E port outlets are indicated on the U side or D side, the P, E ports on the opposite side are plugged.
- External pilot port positions are the same as P, E port outlet positions.

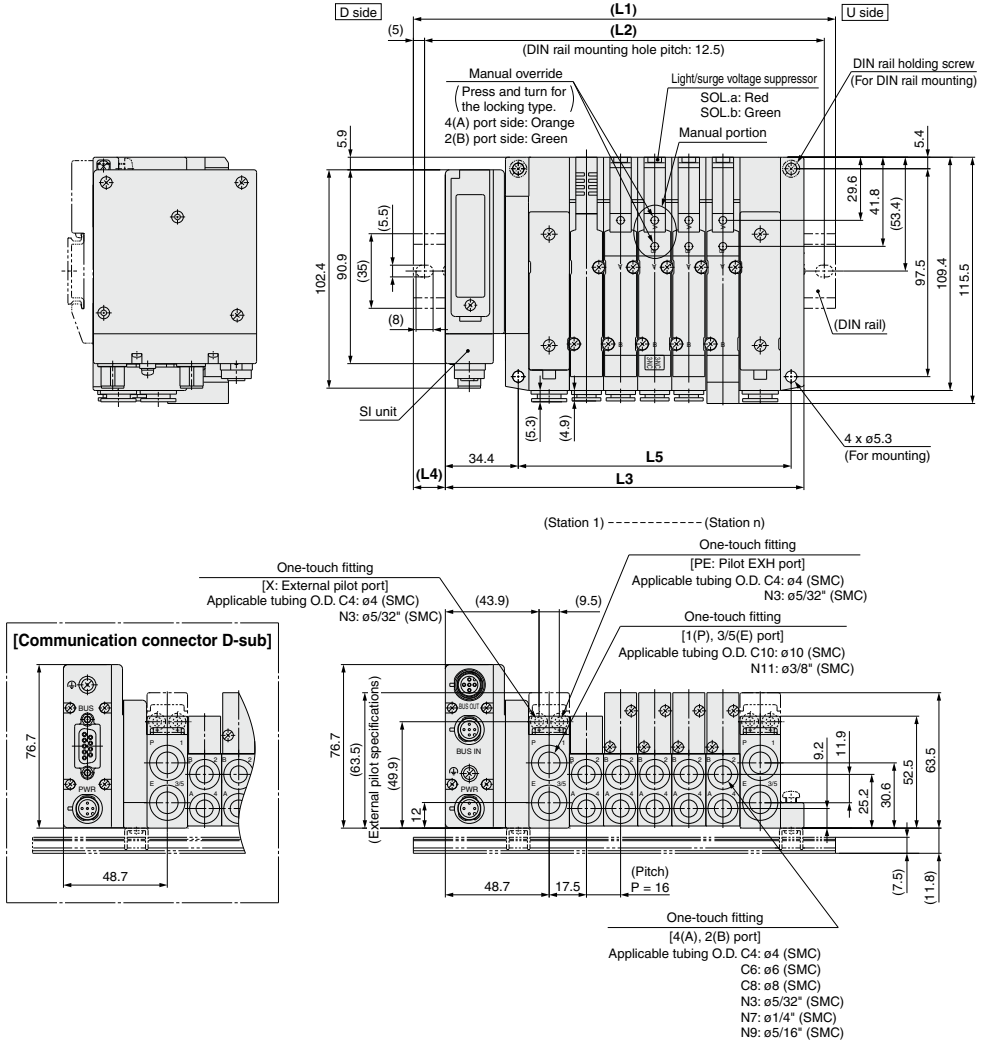

**L: DIN Rail Overall Length**

L	n: Stations																			
	2	3	4	5	6	7	8	9	10	11	12	13	14	15	16	17	18	19	20	
L1	148	160.5	185.5	198	210.5	235.5	248	260.5	273	298	310.5	323	335.5	360.5	373	385.5	410.5	423	435.5	
L2	137.5	150	175	187.5	200	225	237.5	250	262.5	287.5	300	312.5	325	350	362.5	375	400	412.5	425	
L3	120.2	136.2	152.2	168.2	184.2	200.2	216.2	232.2	248.2	264.2	280.2	296.2	312.2	328.2	344.2	360.2	376.2	392.2	408.2	
L4	14	12	16.5	15	13	17.5	16	14	12.5	17	15	13.5	11.5	16	14.5	12.5	17	15.5	13.5	
L5	80	96	112	128	144	160	176	192	208	224	240	256	272	288	304	320	336	352	368	

Directional Control Valves

Air Cylinders

Rotary Actuators

Air Grippers

Air Preparation Equipment

Modular F. R.

Pressure Control Equipment

Fittings & Tubing

Flow Control Equipment

Pressure Switches/ Pressure Sensors



# Integrated Type (For Output) Serial Transmission System

## Series EX126

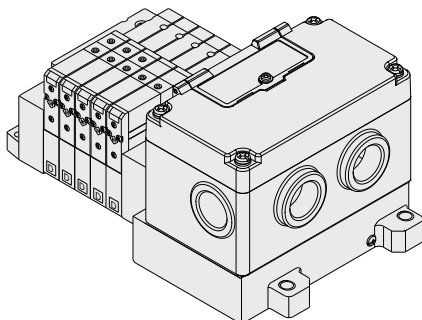

**IP67 compliant**

Applicable series	Tie-rod base manifold SV1000/SV2000/SV3000
	· Number of outputs: 16

Directional  
Control Valves

Air Cylinders

Rotary Actuators

Air Grippers

Air Preparation  
Equipment

Modular F. R.

Pressure Control  
Equipment

Fittings & Tubing

Flow Control  
Equipment

Pressure Switches/  
Pressure Sensors



# Series 10-SV

EX126 Dedicated Output Serial Wiring



## How to Order

### ● Tie-rod base

10-SS5V **1** - W 10S4    D-05 **U**    -    -   

Series	
1	10-SV1000
2	10-SV2000
3	10-SV3000

● Enclosure  
IP67

● SI unit

0	Without SI unit and end plate
VW	CC-Link

- When the SI unit is not included, only the terminal block plate is included.

● Valve stations

Symbol	Stations	Note
02	2 stations	Double wiring <sup>Note 1)</sup>
⋮	⋮	
08	8 stations	
02	2 stations	Specified layout <sup>Note 2)</sup> (up to 16 solenoids possible.)
⋮	⋮	
16	16 stations	

Note 1) Double wiring: Single, double, 3 position and 4 position solenoid valves can be used on all manifold stations. Use of a single solenoid will result in an unused control signal. If this is not desired, order with a specified layout.

Note 2) Specified layout: Indicate wiring specifications on the manifold specification sheet. (Note that double, 3 and 4 position valves cannot be used where single solenoid wiring has been specified.)

● Mounting

Nil	Direct mounting
D	DIN rail mounting (With DIN rail)
D0 <sup>Note)</sup>	DIN rail mounting (Without DIN rail)
D3	For 3 stations
⋮	⋮
D16	For 16 stations

Note) For D0, only DIN rail mounting bracket is attached.

● SUP/EXH block assembly

Nil	Internal pilot
R	External pilot

### SI Unit Part No.

Symbol	Protocol type	SI unit part no.
VW	CC-Link	EX126D-SMJ1

Refer to the **WEB catalog** and the Operation Manual for the details of the EX126 Integrated-type (For Output) Serial Transmission System. Please download the Operation Manual via our website, <http://www.smcworld.com>.

● P, E port location

U	U side (2 to 10 stations)
D	D side (2 to 10 stations)
B	Both sides (2 to 16 stations)

● A, B port size (Metric)

Symbol	A, B port	P, E port	Applicable series
C3	ø3.2 One-touch fitting	ø8 One-touch fitting	10-SV1000
C4	ø4 One-touch fitting		
C6	ø6 One-touch fitting		
C4	ø4 One-touch fitting	ø10 One-touch fitting	10-SV2000
C6	ø6 One-touch fitting		
C8	ø8 One-touch fitting		
C6	ø6 One-touch fitting	ø12 One-touch fitting	10-SV3000
C8	ø8 One-touch fitting		
C10	ø10 One-touch fitting		
M	Mixed		

● A, B port size (Inch)

Symbol	A, B port	P, E port	Applicable series
N1	ø1/8" One-touch fitting	ø5/16" One-touch fitting	10-SV1000
N3	ø5/32" One-touch fitting		
N7	ø1/4" One-touch fitting		
N3	ø5/32" One-touch fitting	ø3/8" One-touch fitting	10-SV2000
N7	ø1/4" One-touch fitting		
N9	ø5/16" One-touch fitting		
N7	ø1/4" One-touch fitting	ø3/8" One-touch fitting	10-SV3000
N9	ø5/16" One-touch fitting		
N11	ø3/8" One-touch fitting		
M	Mixed		

\* For mixed specifications (M), indicate separately on the manifold specification sheet.

\* External pilot type (R) X, PE port sizes are ø4 (metric), ø5/32" (inch) for the 10-SV1000/2000 series and ø6 (metric), ø1/4" (inch) for the 10-SV3000 series.

## How to Order Manifold Assembly

### Ordering example (10-SV1000)

Manifold  
10-SS5V1-W10S4VWD-05B-C6 (1 set)

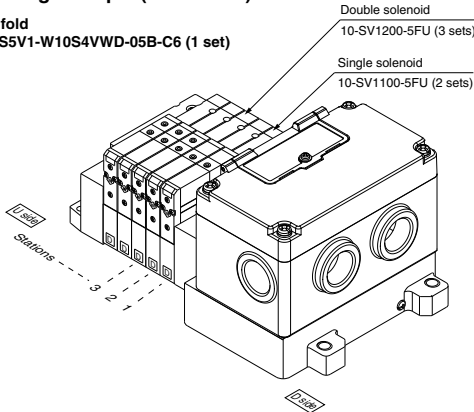

10-SS5V1-W10S4VWD-05B-C6 ..... 1 set (manifold part no.)  
 \* 10-SV1100-5FU ..... 2 sets (manifold part no.)  
 \* 10-SV1200-5FU ..... 3 sets (manifold part no.)

## How to Order Valve

10-SV 1 1 00 - 5 F - -

Series

1	10-SV1000
2	10-SV2000
3	10-SV3000

Actuation type

1	2 position single
2	2 position double
3	3 position closed center
4	3 position exhaust center
5	3 position pressure center
A	4 position dual 3 port valve: N.C./N.C.
B	4 position dual 3 port valve: N.O./N.O.
C	4 position dual 3 port valve: N.C./N.O.

\* 4 position dual 3 port valves are applicable to the 10-SV1000 and 10-SV2000 series only.

Pilot type

Nil	Internal pilot
R	External pilot

\* External pilot specifications are not available for 4 position dual 3 port valves.

Back pressure check valve

Nil	None
K	Built-in

\* The built-in back pressure check valve type is applicable to the 10-SV1000 series only.  
 \* The product with back pressure check valve is not available for 3 position valves.

Rated voltage

5	24 VDC
---	--------

Note) Available with manifold block for station additions. Refer to the WEB catalog.

Made to Order

Nil	-
X90	Main valve fluororubber (Refer to page 272.)

Manual override

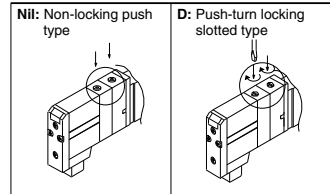

Light/Surge voltage suppressor

U	With light/surge voltage suppressor
R	With surge voltage suppressor

Note) Refer to the Specific Product Precautions 2 on page 274.

Directional Control Valves  
 Air Cylinders  
 Rotary Actuators  
 Air Grippers  
 Air Preparation Equipment  
 Modular F. R.  
 Pressure Control Equipment  
 Fittings & Tubing  
 Flow Control Equipment  
 Pressure Switches/Pressure Sensors

**Dimensions: Series 10-SV1000 for EX126 Integrated-type (For Output) Serial Transmission System**

● Tie-rod base manifold: 10-SS5V1-W10S4 □ D- Stations  $\frac{U}{B}$  (R)  $\frac{C3, N1}{C4, N3}$   $\frac{C6, N7}{C8, N7}$  (-D)

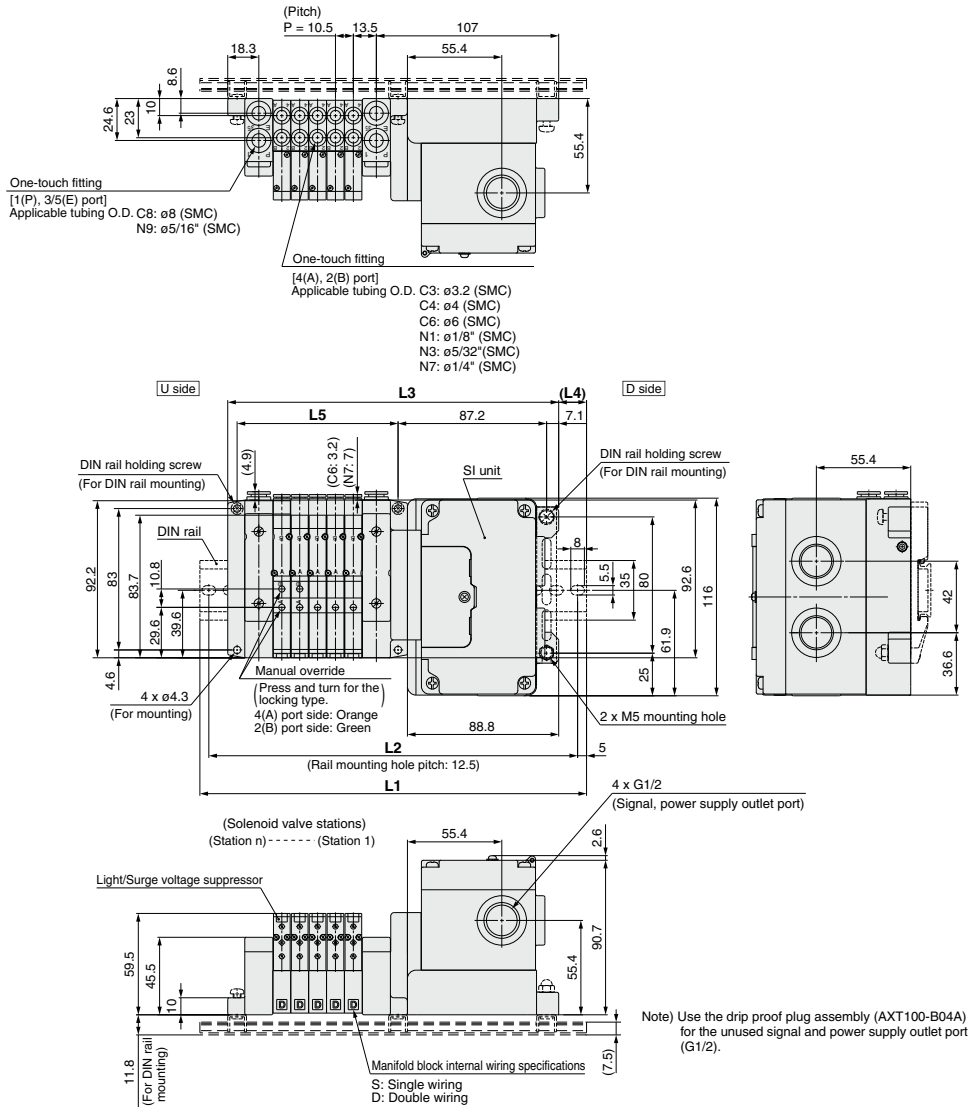

**L Dimension**

n	2	3	4	5	6	7	8	9	10	11	12	13	14	15	16
L1	198	198	210.5	223	235.5	248	260.5	260.5	273	285.5	298	310.5	323	323	335.5
L2	187.5	187.5	200	212.5	225	237.5	250	250	262.5	275	287.5	300	312.5	312.5	325
L3	162.8	173.3	183.8	194.3	204.8	215.3	225.8	236.3	246.8	257.3	267.8	278.3	288.8	299.3	309.8
L4	17.5	12.5	13.5	14.5	15.5	16.5	17.5	12	13	14	15	16	17	12	13
L5	63	73.5	84	94.5	105	115.5	126	136.5	147	157.5	168	178.5	189	199.5	210

Dimensions: Series 10-SV2000 for EX126 Integrated-type (For Output) Serial Transmission System

● Tie-rod base manifold: 10-SS5V2-W10S4 □ D-<sup>U</sup>Stations<sub>B</sub>(R)<sup>CA, NB</sup> / <sup>CS, NS</sup> (-D)

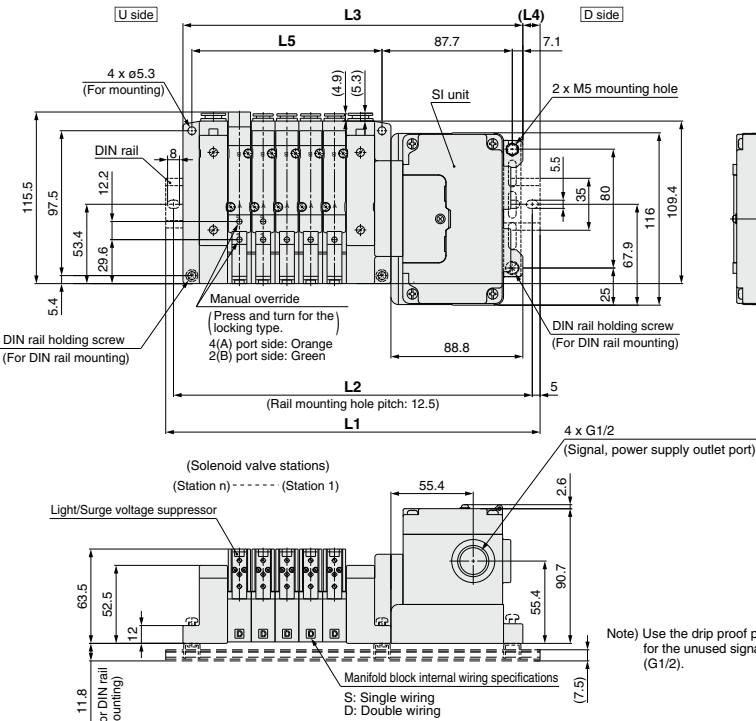
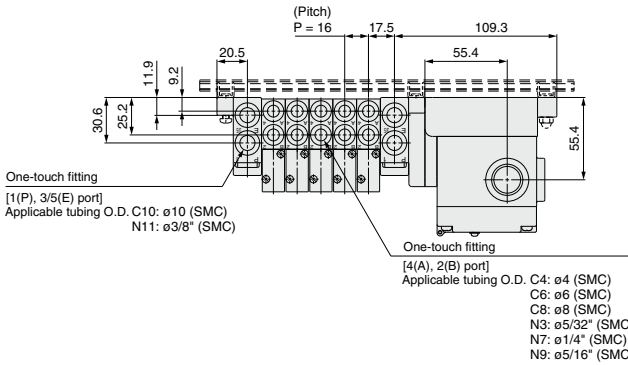

Note) Use the drip proof plug assembly (AXT100-B04A) for the unused signal and power supply outlet port (G1/2).

L Dimension

n	2	3	4	5	6	7	8	9	10	11	12	13	14	15	16
L1	210.5	223	248	260.5	273	285.5	310.5	323	335.5	348	373	385.5	398	423	435.5
L2	200	212.5	237.5	250	262.5	275	300	312.5	325	337.5	362.5	375	387.5	412.5	425
L3	180.8	196.8	212.8	228.8	244.8	260.8	276.8	292.8	308.8	324.8	340.8	356.8	372.8	388.8	404.8
L4	15	13	17.5	16	14	12.5	17	15	13.5	11.5	16	14.5	12.5	17	15.5
L5	80	96	112	128	144	160	176	192	208	224	240	256	272	288	304

n: Stations

Directional Control Valves  
Air Cylinders  
Rotary Actuators  
Air Grippers  
Air Preparation Equipment  
Modular F. R.  
Pressure Control Equipment  
Fittings & Tubing  
Flow Control Equipment  
Pressure Switches/Pressure Sensors

**Dimensions: Series 10-SV3000 for EX126 Integrated-type (For Output) Serial Transmission System**

● Tie-rod base manifold: 10-SS5V3-W10S4 □ D-Stations<sub>U</sub><sub>B</sub>(R) <sup>C6, N7</sup> <sup>C8, N9</sup> <sup>C10, N11</sup> (-D)

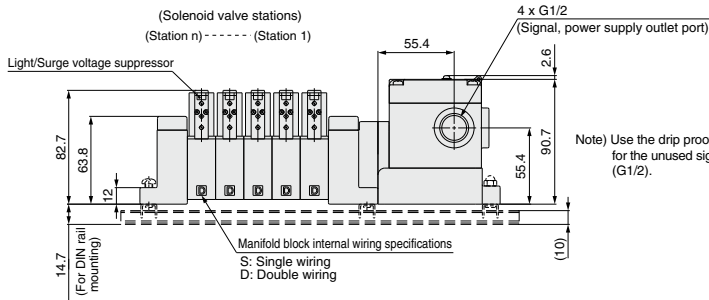
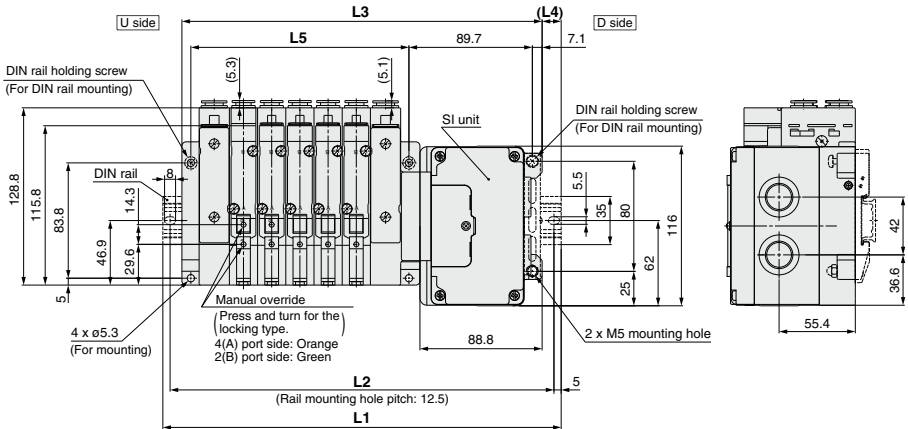
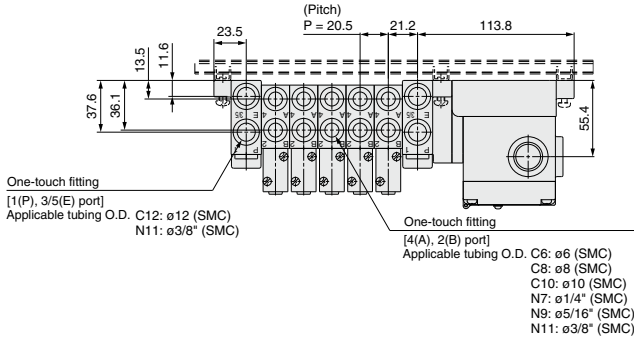

Note) Use the drip proof plug assembly (AXT100-B04A) for the unused signal and power supply outlet port (G1/2).

**L Dimension**

n	2	3	4	5	6	7	8	9	10	11	12	13	14	15	16
L1	235.5	248	273	285.5	310.5	335.5	348	373	398	410.5	435.5	460.5	473	498	510.5
L2	225	237.5	262.5	275	300	325	337.5	362.5	387.5	400	425	450	462.5	487.5	500
L3	200.3	220.8	241.3	261.8	282.3	302.8	323.3	343.8	364.3	384.8	405.3	425.8	446.3	466.8	487.3
L4	17.5	13.5	16	12	14	16.5	12.5	14.5	17	13	15	17.5	13.5	15.5	11.5
L5	97	117.5	138	158.5	179	199.5	220	240.5	261	281.5	302	322.5	343	363.5	384

# Circular Connector

IP67 compliant

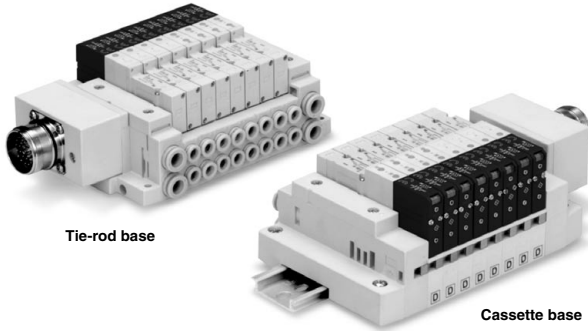

Applicable series	Cassette base manifold <b>10-SV1000/10-SV2000</b>
	Tie-rod base manifold <b>10-SV1000/10-SV2000/10-SV3000/10-SV4000</b>
· Number of connectors: 26 pins	

Directional Control Valves

Air Cylinders

Rotary Actuators

Air Grippers

Air Preparation Equipment

Modular F. R.

Pressure Control Equipment

Fittings & Tubing

Flow Control Equipment

Pressure Switches/  
Pressure Sensors

# Series 10-SV

Circular Connector



## How to Order

**Series**

1	10-SV1000
2	10-SV2000
3	10-SV3000
4	10-SV4000

**Valve stations**

Symbol	Stations	Note
02	2 stations	Double wiring (Note 1)
:	:	
12	12 stations	Specified layout (Note 2) (Up to 24 solenoids possible)
02	2 stations	
:	:	
20	20 stations	

**Tie-rod base**  
10 - SS5V 1 - W 10CD - 05 U

**Cassette base**  
10 - SS5V 1 - W 16CD - 05 U

**Clean series**

1	10-SV1000
2	10-SV2000

**Enclosure IP67**

**Stations**

**Type 16: Series 10-SV1000**

Symbol	Stations	Note
02	2 stations	Double wiring (Note 1)
:	:	
09	9 stations	Specified layout (Note 2) (Up to 18 solenoids possible)
02	2 stations	
:	:	
18	18 stations	

**Type 16: Series 10-SV2000**

Symbol	Stations	Note
02	2 stations	Double wiring (Note 1)
:	:	
12	12 stations	Specified layout (Note 2) (Up to 24 solenoids possible)
02	2 stations	
:	:	
20	20 stations	

**Mounting**

Nil	Direct mounting
D	DIN rail mounting (With DIN rail)
D0 (Note)	DIN rail mounting (Without DIN rail)
D3	For 3 stations. When a longer DIN rail is desired than the specified stations. (Specify a longer rail than the standard length.)
:	:
D20	For 20 stations.

**DIN rail length specified**

Nil	Standard length
3	For 3 stations. Specify a longer rail than the standard length.
:	:
20 (Note)	For 20 stations.

**P, E port location**

U	U side (2 to 10 stations)
D	D side (2 to 10 stations)
B	Both sides (2 to 20 stations)

**SUP/EXH block assembly**

Nil	Internal pilot
R	External pilot

**A, B port size (Metric)**

Symbol	Specifications	P, E port	Applicable series
C3	ø3.2 One-touch fitting	ø8 One-touch fitting	10-SV1000
C4	ø4 One-touch fitting		
C6	ø6 One-touch fitting		
C4	ø4 One-touch fitting	ø10 One-touch fitting	10-SV2000
C6	ø6 One-touch fitting		
C8	ø8 One-touch fitting	ø12 One-touch fitting	10-SV3000
C6	ø6 One-touch fitting		
C8	ø8 One-touch fitting	ø12 One-touch fitting	10-SV4000
C10	ø10 One-touch fitting		
C8	ø8 One-touch fitting	ø12 One-touch fitting	10-SV4000
C10	ø10 One-touch fitting		
C12	ø12 One-touch fitting	Rc 3/8	10-SV4000
02	Rc 1/4		
03	Rc 3/8	G 3/8	10-SV4000
02F	G 1/4		
03F	G 3/8		
M	Mixed		

**A, B port size (Inch)**

Symbol	Specifications	P, E port	Applicable series
N1	ø1/8" One-touch fitting	ø5/16" One-touch fitting	10-SV1000
N3	ø5/32" One-touch fitting		
N7	ø1/4" One-touch fitting		
N3	ø5/32" One-touch fitting	ø3/8" One-touch fitting	10-SV2000
N7	ø1/4" One-touch fitting		
N9	ø5/16" One-touch fitting	ø3/8" One-touch fitting	10-SV3000
N7	ø1/4" One-touch fitting		
N9	ø5/16" One-touch fitting	ø3/8" One-touch fitting	10-SV4000
N11	ø3/8" One-touch fitting		
N9	ø5/16" One-touch fitting	NPT 3/8	10-SV4000
N11	ø3/8" One-touch fitting		
02N	NPT 1/4	NPTF 3/8	10-SV4000
03N	NPT 3/8		
02T	NPTF 1/4		
03T	NPTF 3/8		
M	Mixed		

**Note 1** Double wiring: Single, double, 3 position and 4 position solenoid valves can be used at all of the manifold stations. Use of a single solenoid will result in an unused control signal. If this is not desired, order with a specified layout.

**Note 2** Specified layout: Indicate wiring specifications on the manifold specification sheet. (Note that double, 3 and 4 position valves cannot be used where single solenoid wiring has been specified.)

**Note** For D0, only DIN rail mounting bracket is attached.

**Note** Able to specify the length for 3 stations up to 18 stations for 10-SV1000, which is available with 18 stations at the maximum.

**Note** For mixed specifications (M), indicate separately on the manifold specification sheet.

**Note** External pilot type (R) X, PE port sizes are ø4 (metric), ø5/32" (inch) for the 10-SV1000/2000 series and ø6 (metric), ø1/4" (inch) for the 10-SV3000/4000 series.

## How to Order Manifold Assembly

### Ordering example (10-SV1000)

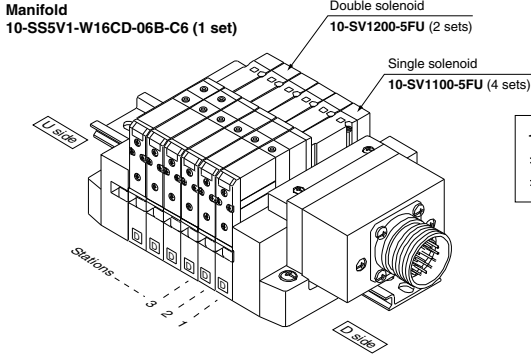

10-SS5V1-W16CD-06B-C6.....1 set (Manifold part no.)  
 \* 10-SV1100-5FU.....4 sets (Single solenoid part no.)  
 \* 10-SV1200-5FU.....2 sets (Double solenoid part no.)

## How to Order Solenoid Valve

**10-SV 1 1 00** **5 F** (Note)

Clean series

Series

1	10-SV1000
2	10-SV2000
3	10-SV3000
4	10-SV4000

Actuation type

1	2 position single solenoid
2	2 position double solenoid
3	3 position closed center
4	3 position exhaust center
5	3 position pressure center
A	4 position dual 3 port valve: N.C./N.C.
B	4 position dual 3 port valve: N.O./N.O.
C	4 position dual 3 port valve: N.C./N.O.

\* 4 position dual 3 port valves are applicable to the 10-SV1000 and 10-SV2000 series only.

Pilot type

Nil	Internal pilot
R	External pilot

\* External pilot specifications are not available for 4 position dual 3 port valves.

Back pressure check valve

Nil	None
K	Built-in

\* The built-in back pressure check valve type is applicable to the 10-SV1000 series only.  
 \* The product with back pressure check valve is not available for 3 position solenoid valves.

Note) Available with manifold block for station additions. Refer to the **WEB catalog**.

Made to Order

Nil	—
X90	Main valve fluororubber (Refer to page 272.)

Manual override

Nil: Non-locking push type	D: Push-turn locking slotted type
----------------------------	-----------------------------------

Light/surge voltage suppressor

U	With light/surge voltage suppressor
R	With surge voltage suppressor

Rated voltage

5	24 VDC
6	12 VDC

Note) Refer to the Specific Product Precautions 2 on page 274.

Directional Control Valves  
 Air Cylinders  
 Rotary Actuators  
 Air Grippers  
 Air Preparation Equipment  
 Modular F. R.  
 Pressure Control Equipment  
 Fittings & Tubing  
 Flow Control Equipment  
 Pressure Switches/ Pressure Sensors



## Manifold Electrical Wiring

### 10C/16C Circular Connector Type (26 pins)

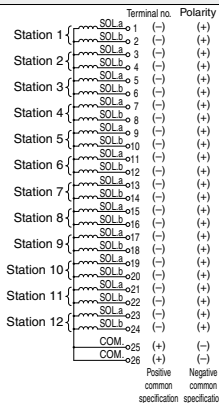

- This circuit is for the double wiring specification with up to 12 stations. Since the usable number of solenoids differs depending on the manifold type, refer to the table below. For single solenoids, connect to SOL.A. Furthermore, when wiring is specified on the manifold specification sheet, connections are made without skipping any connectors, and signals A for single and A, B for double are in order 1 → 2 → 3 → 4, etc.
- Stations are counted from the D side (connector side) as the 1st one.
- Since solenoid valves do not have polarity, either the +COM or -COM can be used.

#### Usable No. of Solenoids

Model		Max. no. of solenoids
Type 10, Tie-rod base	<b>10-SV1000</b>	24
	<b>10-SV4000</b>	
Type 16, Cassette base	<b>10-SV1000</b>	18
	<b>10-SV2000</b>	24

**Dimensions: Series 10-SV1000 for Circular Connector**

• **Cassette base manifold: 10-SS5V1-W16CD-** Stations  $\frac{U}{D}$  (R) - C3, N1  
C4, N3  
C6, N7

• When P, E port outlets are indicated on the U side or D side, the P, E ports on the opposite side are plugged.  
• External pilot port positions are the same as P, E port outlet positions.

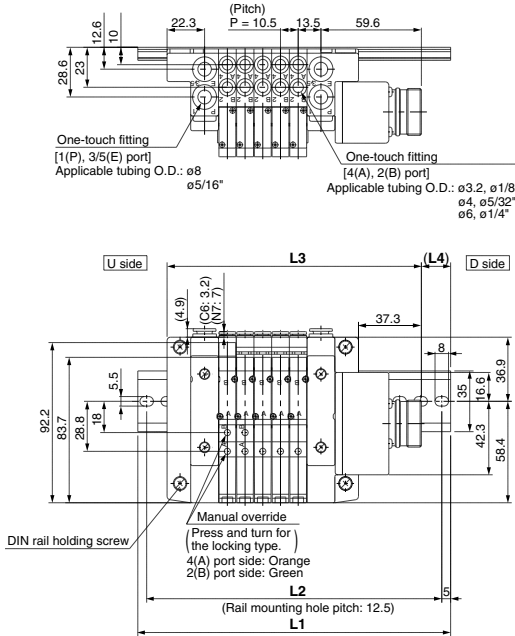

**With external pilot specifications**

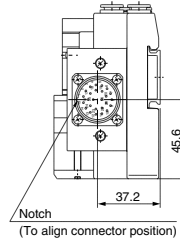
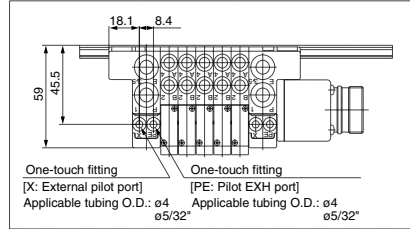

**With option**

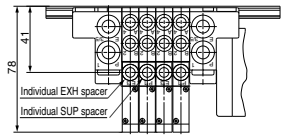
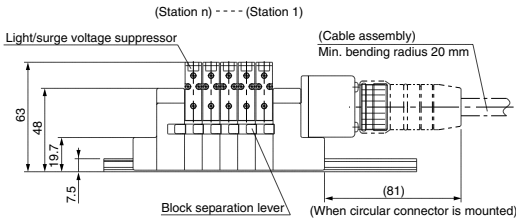

**L Dimension**

n: Stations

L	2	3	4	5	6	7	8	9	10	11	12	13	14	15	16	17	18
L1	148	160.5	173	185.5	185.5	198	210.5	223	235.5	248	248	260.5	273	285.5	298	310.5	310.5
L2	137.5	150	162.5	175	175	187.5	200	212.5	225	237.5	237.5	250	262.5	275	287.5	300	300
L3	119.3	129.8	140.3	150.8	161.3	171.8	182.3	192.8	203.3	213.8	224.3	234.8	245.3	255.8	266.3	276.8	287.3
L4	14.5	15.5	16.5	17.5	12	13	14	15	16	17	12	13	14	15	16	17	11.5

Directional Control Valves

Air Cylinders

Rotary Actuators

Air Grippers

Air Preparation Equipment

Modular F. R.

Pressure Control Equipment

Fittings & Tubing

Flow Control Equipment

Pressure Switches/ Pressure Sensors

**Dimensions: Series 10-SV2000 for Circular Connector**

• **Cassette base manifold: 10-SS5V2-W16CD-** Stations  $\begin{matrix} U \\ D \end{matrix}$  (R) -  $\begin{matrix} C4, N3 \\ C6, N7 \\ C8, N9 \end{matrix}$

• When P, E port outlets are indicated on the U side or D side, the P, E ports on the opposite side are plugged.  
 • External pilot port positions are the same as P, E port outlet positions.

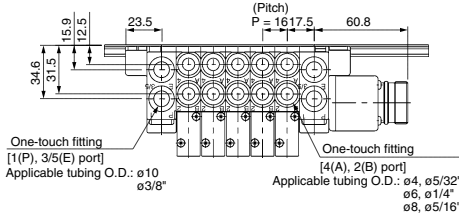

**With external pilot specifications**

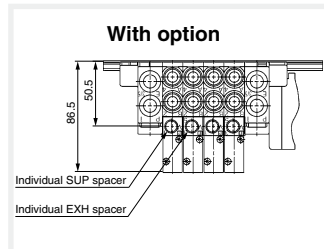
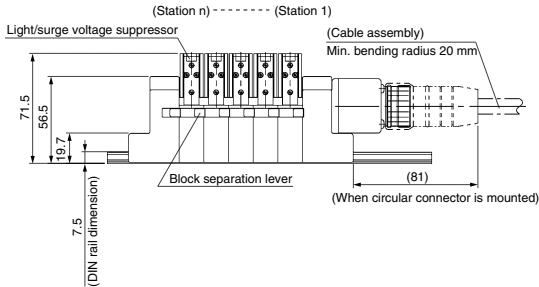
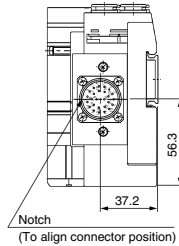
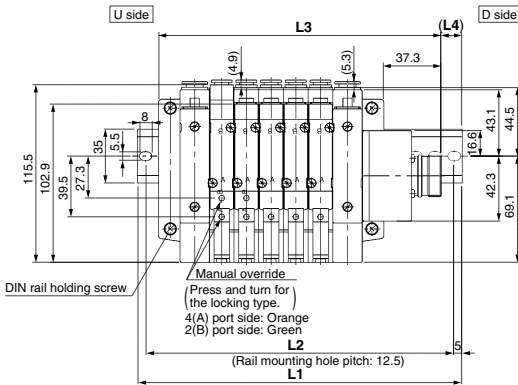
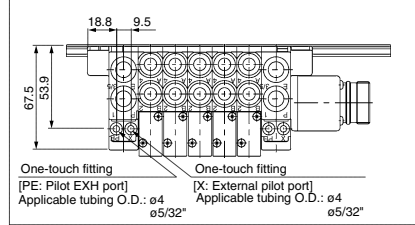

**L Dimension**

n: Stations

n	2	3	4	5	6	7	8	9	10	11	12	13	14	15	16	17	18	19	20
L1	160.5	185.5	198	210.5	223	248	260.5	273	298	310.5	323	335.5	360.5	373	385.5	410.5	423	435.5	448
L2	150	175	187.5	200	212.5	237.5	250	262.5	287.5	300	312.5	325	350	362.5	375	400	412.5	425	437.5
L3	135.3	151.3	167.3	183.3	199.3	215.3	231.3	247.3	263.3	279.3	295.3	311.3	327.3	343.3	359.3	375.3	391.3	407.3	423.3
L4	12.5	17	15.5	13.5	12	16.5	14.5	13	17.5	15.5	14	12	16.5	15	13	17.5	16	14	12.5



**Dimensions: Series 10-SV2000 for Circular Connector**

• Tie-rod base manifold: 10-SS5V2-W10CD-**Stations**  $\begin{matrix} U \\ D \end{matrix}$  (R) -  $\begin{matrix} C4, N3 \\ C6, N7 \\ C8, N9 \end{matrix}$  (-D)

• When P, E port outlets are indicated on the U side or D side, the P, E ports on the opposite side are plugged.  
 • External pilot port positions are the same as P, E port outlet positions.

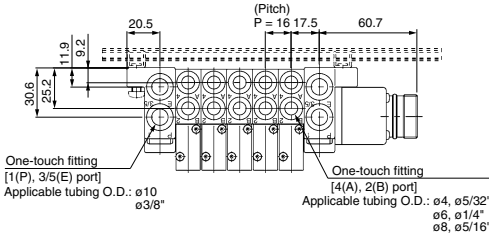

**With external pilot specifications**

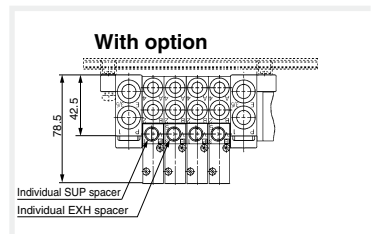
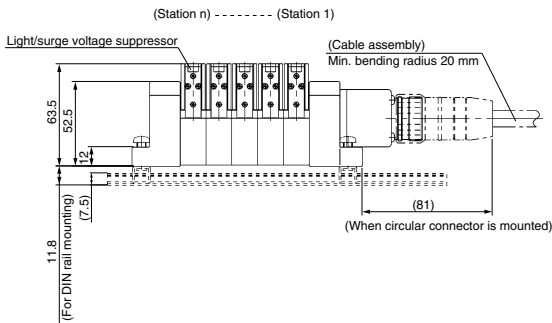
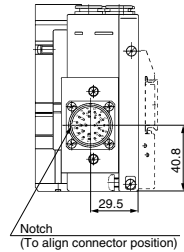
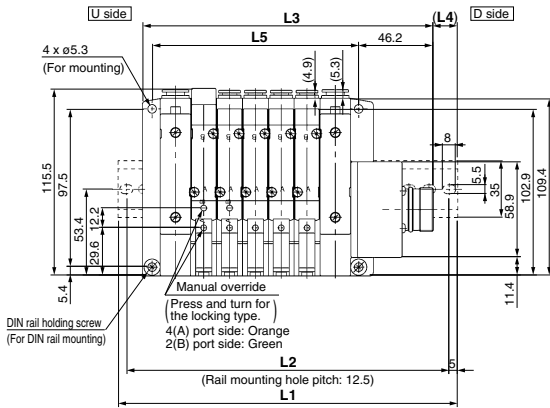
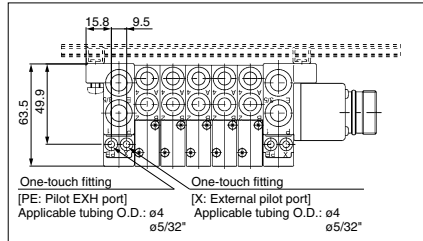

**L Dimension**

n: Stations

n	2	3	4	5	6	7	8	9	10	11	12	13	14	15	16	17	18	19	20
L1	160.5	173	198	210.5	223	235.5	260.5	273	285.5	310.5	323	335.5	348	373	385.5	398	423	435.5	448
L2	150	162.5	187.5	200	212.5	225	250	262.5	275	300	312.5	325	337.5	362.5	375	387.5	412.5	425	437.5
L3	132.2	148.2	164.2	180.2	196.2	212.2	228.2	244.2	260.2	276.2	292.2	308.2	324.2	340.2	356.2	372.2	388.2	404.2	420.2
L4	14	12.5	17	15	13.5	11.5	16	14.5	12.5	17	15.5	13.5	12	16.5	14.5	13	17.5	15.5	14
L5	80	96	112	128	144	160	176	192	208	224	240	256	272	288	304	320	336	352	368

## Dimensions: Series 10-SV3000 for Circular Connector

### • Tie-rod base manifold: 10-SS5V3-W10CD- $\begin{matrix} \text{U} \\ \text{D} \end{matrix}$ (R) - $\begin{matrix} \text{C6, N7} \\ \text{C8, N9} \\ \text{C10, N11} \end{matrix}$ (-D)

• When P, E port outlets are indicated on the U side or D side, the P, E ports on the opposite side are plugged.  
 • External pilot port positions are the same as P, E port outlet positions.

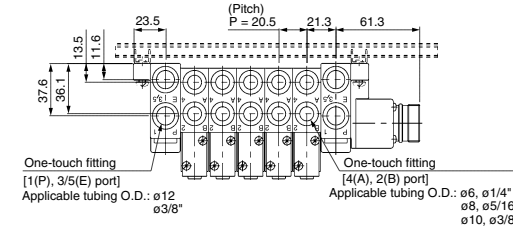

#### With external pilot specifications

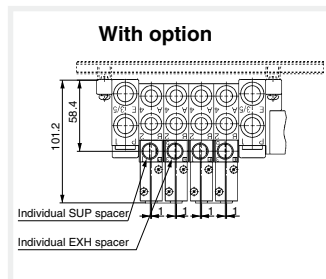
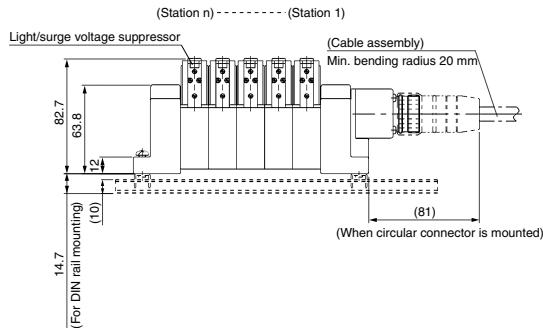
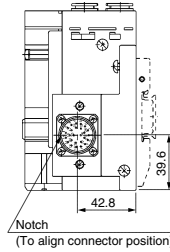
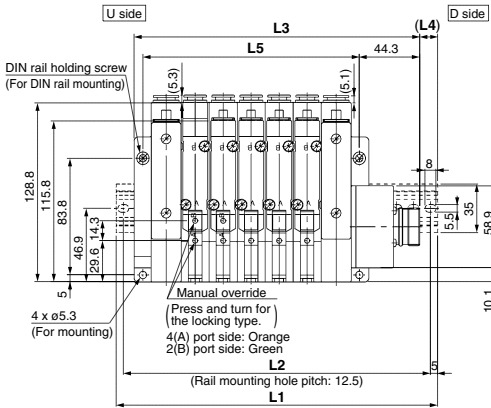
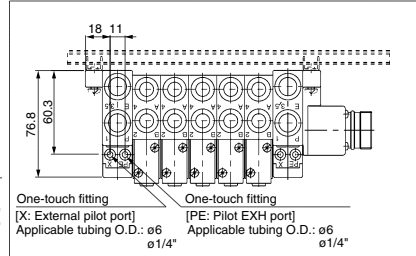

#### L Dimension

n: Stations

n	2	3	4	5	6	7	8	9	10	11	12	13	14	15	16	17	18	19	20
L1	173	198	223	235.5	260.5	285.5	298	323	335.5	360.5	385.5	398	423	448	460.5	485.5	510.5	523	548
L2	162.5	187.5	212.5	225	250	275	287.5	312.5	325	350	375	387.5	412.5	437.5	450	475	500	512.5	537.5
L3	147.8	168.3	188.8	209.3	229.8	250.3	270.8	291.3	311.8	332.3	352.8	373.3	393.8	414.3	434.8	455.3	475.8	496.3	516.8
L4	12.5	15	17	13	15.5	17.5	13.5	16	12	14	16.5	12.5	14.5	17	13	15	17.5	13.5	15.5
L5	97	117.5	138	158.5	179	199.5	220	240.5	261	281.5	302	322.5	343	363.5	384	404.5	425	445.5	466

Directional Control Valves  
 Air Cylinders  
 Rotary Actuators  
 Air Grippers  
 Air Preparation Equipment  
 Modular F. R.  
 Pressure Control Equipment  
 Fittings & Tubing  
 Flow Control Equipment  
 Pressure Switches/ Pressure Sensors

**Dimensions: Series 10-SV4000 for Circular Connector**

• Tie-rod base manifold: 10-SS5V4-W10CD- **Stations**  $\frac{U}{D}$  (R) -  $\frac{02}{03}$   $\frac{C8, N9}{C10, N11}$  (-D)

When P, E port outlets are indicated on the U side or D side, the P, E ports on the opposite side are plugged.  
External pilot port positions are the same as P, E port outlet positions.

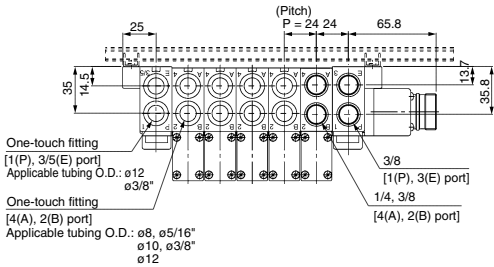

**With external pilot specifications**

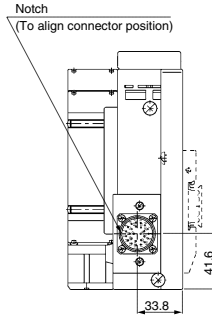
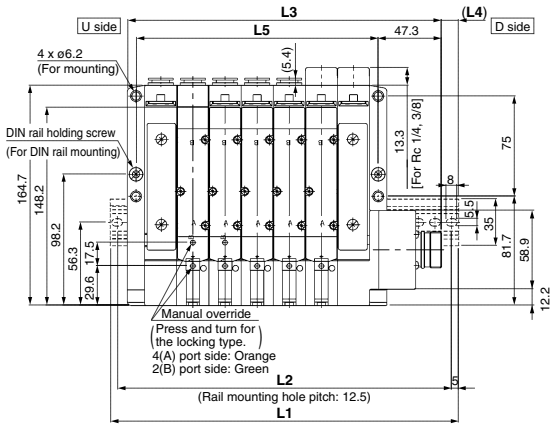
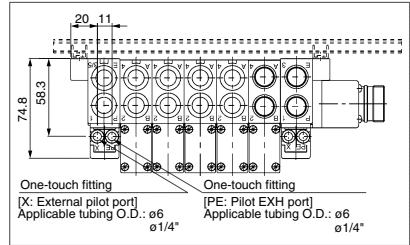

(Station n) ----- (Station 1)

Light/surge voltage suppressor

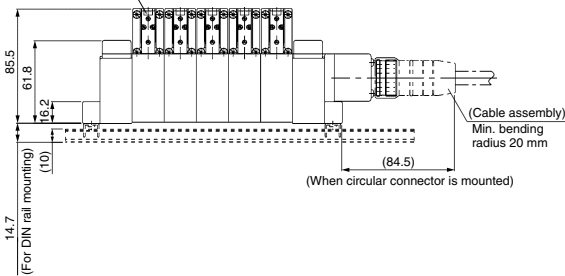

**With option**

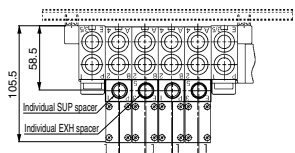

**L Dimension**

n: Stations

n	2	3	4	5	6	7	8	9	10	11	12	13	14	15	16	17	18	19	20
L1	198	210.5	235.5	260.5	285.5	310.5	335.5	360.5	385.5	410.5	435.5	460.5	485.5	498	523	548	573	598	623
L2	187.5	200	225	250	275	300	325	350	375	400	425	450	475	487.5	512.5	537.5	562.5	587.5	612.5
L3	162.8	186.8	210.8	234.8	258.8	282.8	306.8	330.8	354.8	378.8	402.8	426.8	450.8	474.8	498.8	522.8	546.8	570.8	594.8
L4	17.5	12	12.5	13	13.5	14	14.5	15	15.5	16	16.5	17	17.5	11.5	12	12.5	13	13.5	14
L5	109	133	157	181	205	229	253	277	301	325	349	373	397	421	445	469	493	517	541

# D-sub Connector

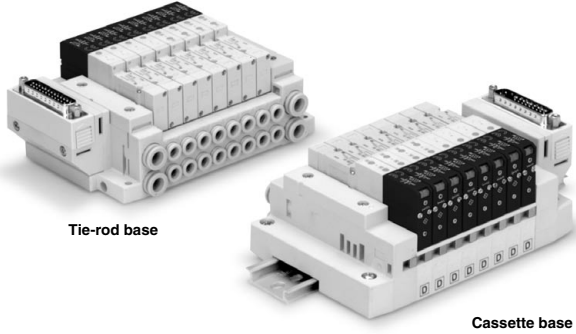

Tie-rod base

Cassette base

Applicable series	Cassette base manifold <b>10-SV1000/10-SV2000</b>
	Tie-rod base manifold <b>10-SV1000/10-SV2000/10-SV3000/10-SV4000</b>
<ul style="list-style-type: none"> <li>· Number of connectors: 25 pins</li> <li>· MIL-C-24308</li> <li>· Conforming to JIS-X-5101</li> </ul>	

Directional Control Valves

Air Cylinders

Rotary Actuators

Air Grippers

Air Preparation Equipment

Modular F. R.

Pressure Control Equipment

Fittings & Tubing

Flow Control Equipment

Pressure Switches/ Pressure Sensors



# Series 10-SV

D-sub Connector



## How to Order

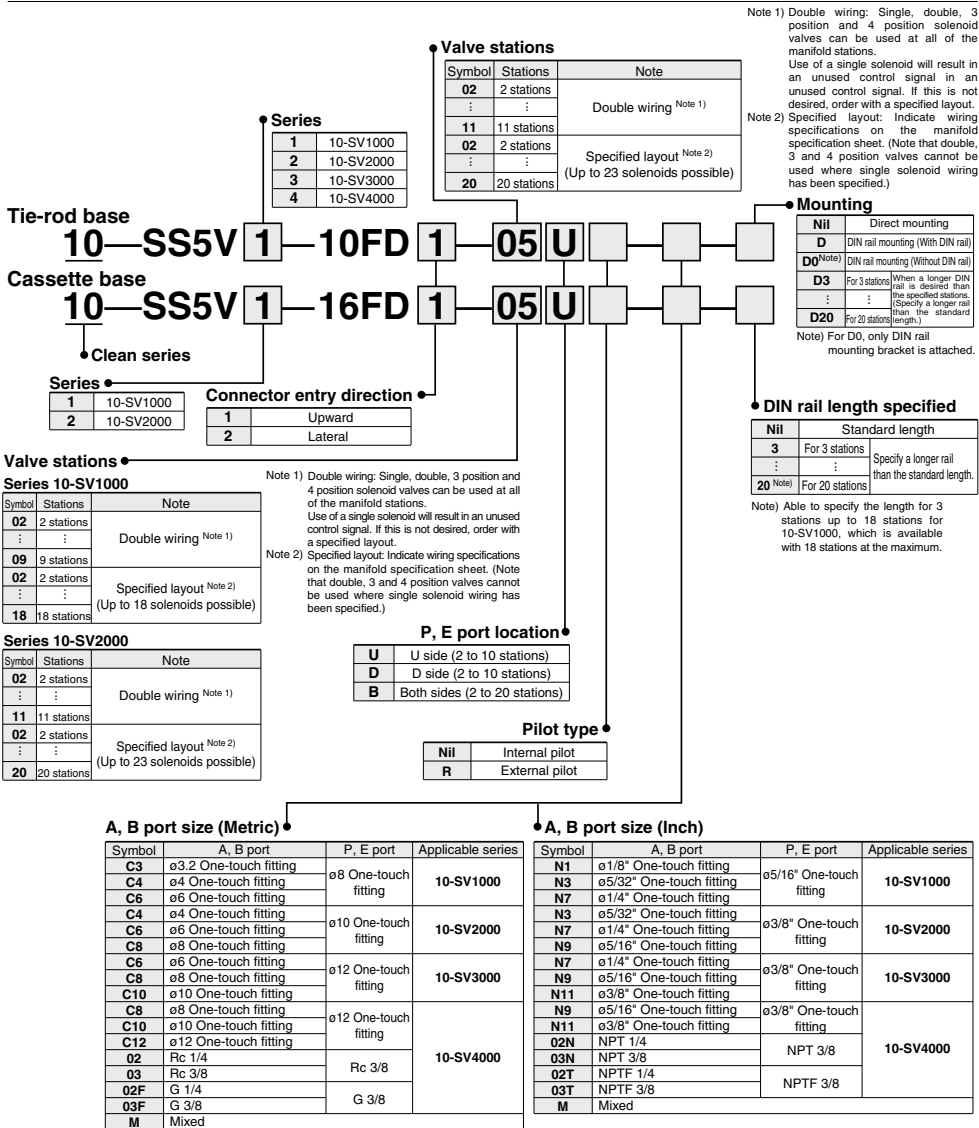

## How to Order Manifold Assembly

### Ordering example (10-SV1000)

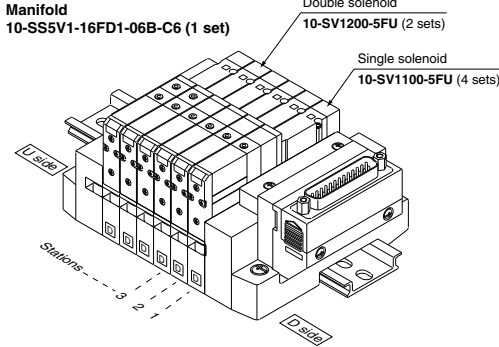

10-SS5V1-16FD1-06B-C6.....1 set (Manifold part no.)  
 \* 10-SV1100-5FU.....4 sets (Single solenoid part no.)  
 \* 10-SV1200-5FU.....2 sets (Double solenoid part no.)

## How to Order Solenoid Valve

**10 - SV 1 1 00 - 5 F -** (Note)

**Clean series**

1	10-SV1000
2	10-SV2000
3	10-SV3000
4	10-SV4000

**Series**

**Actuation type**

1	2 position single solenoid
2	2 position double solenoid
3	3 position closed center
4	3 position exhaust center
5	3 position pressure center
A	4 position dual 3 port valve: N.C./N.C.
B	4 position dual 3 port valve: N.O./N.O.
C	4 position dual 3 port valve: N.C./N.O.

\* 4 position dual 3 port valves are applicable to the 10-SV1000 and 10-SV2000 series only.

**Pilot type**

Nil	Internal pilot
R	External pilot

\* External pilot specifications are not available for 4 position dual 3 port valves.

**Note**) Available with manifold block for station additions. Refer to the **WEB catalog**.

**Made to Order**

Nil	—
X90	Main valve fluororubber (Refer to page 272.)

**Manual override**

Nil: Non-locking push type	D: Push-turn locking slotted type
----------------------------	-----------------------------------

**Light/surge voltage suppressor**

U	With light/surge voltage suppressor
R	With surge voltage suppressor

**Rated voltage**

5	24 VDC
6	12 VDC

**Back pressure check valve**

Nil	None
K	Built-in

\* The built-in back pressure check valve type is applicable to the 10-SV1000 series only.  
 \* The product with back pressure check valve is not available for 3 position solenoid valves.  
 (Note) Refer to the Specific Product Precautions 2 on page 274.

Directional Control Valves  
 Air Cylinders  
 Rotary Actuators  
 Air Grippers  
 Air Preparation Equipment  
 Modular F. R.  
 Pressure Control Equipment  
 Fittings & Tubing  
 Flow Control Equipment  
 Pressure Switches/ Pressure Sensors

## Manifold Electrical Wiring

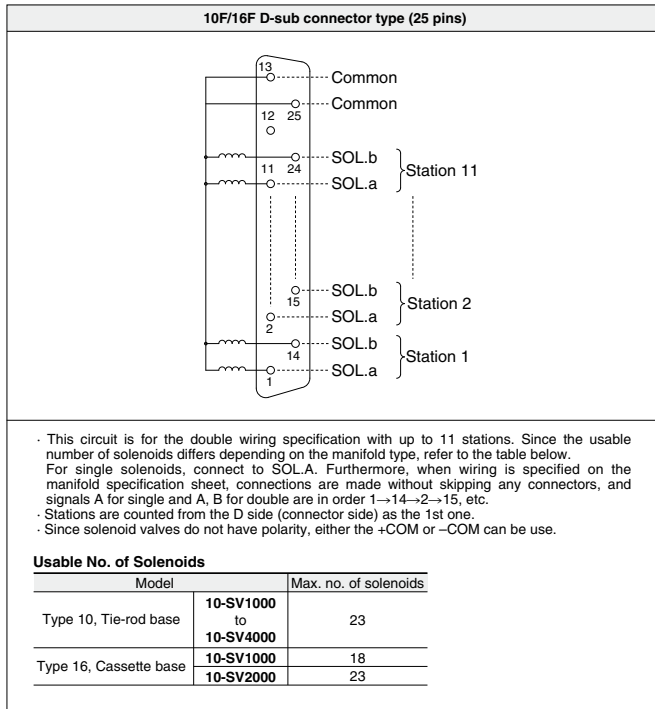

**Dimensions: Series 10-SV1000 for D-sub Connector**

• **Cassette base manifold: 10-SS5V1-16FD<sub>2</sub> - [Stations] <sup>U</sup><sub>D</sub> (R)-** C3, N1  
C4, N3  
C6, N7

• When P, E port outlets are indicated on the U side or D side, the P, E ports on the opposite side are plugged.  
• External pilot port positions are the same as P, E port outlet positions.

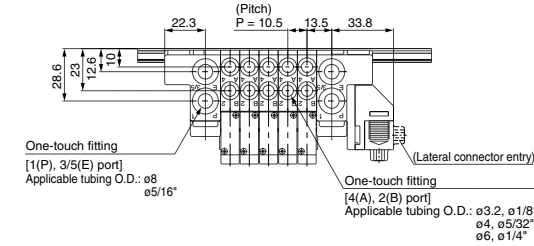

**With external pilot specifications**

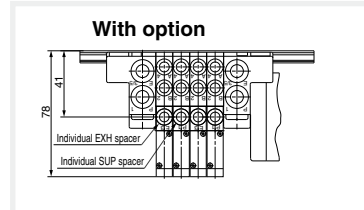
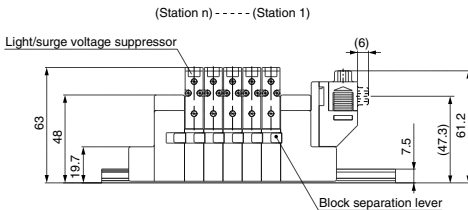
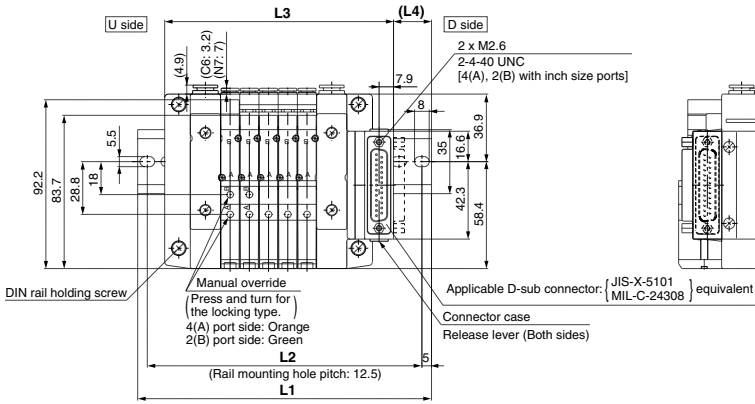
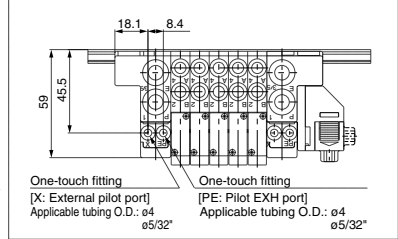

**L Dimension**

n	2	3	4	5	6	7	8	9	10	11	12	13	14	15	16	17	18
L1	123	135.5	148	160.5	173	185.5	198	198	210.5	223	235.5	248	260.5	260.5	273	285.5	298
L2	112.5	125	137.5	150	162.5	175	187.5	187.5	200	212.5	225	237.5	250	250	262.5	275	287.5
L3	93.5	104	114.5	125	135.5	146	156.5	167	177.5	188	198.5	209	219.5	230	240.5	251	261.5
L4	18	19	20	21	22	23	24	18.5	19.5	20.5	21.5	22.5	23.5	18.5	19.5	20.5	21.5

n: Stations

Directional Control Valves  
 Air Cylinders  
 Rotary Actuators  
 Air Grippers  
 Air Preparation Equipment  
 Modular F. R.  
 Pressure Control Equipment  
 Fittings & Tubing  
 Flow Control Equipment  
 Pressure Switches/ Pressure Sensors

Dimensions: Series 10-SV2000 for D-sub Connector

• Cassette base manifold: 10-SS5V2-16FD<sub>2</sub> - [Stations]  $\frac{U}{D}$  (R) C4, N3  
C6, N7  
C8, N9

When P, E port outlets are indicated on the U side or D side, the P, E ports on the opposite side are plugged.  
External pilot port positions are the same as P, E port outlet positions.

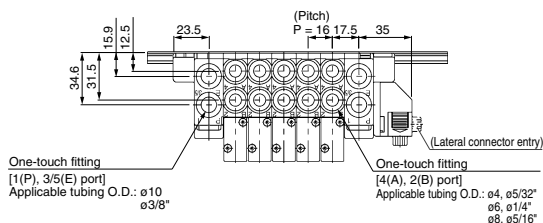

With external pilot specifications

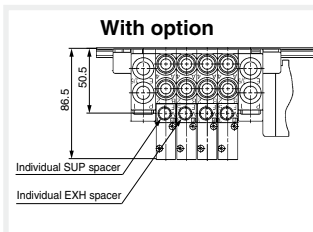
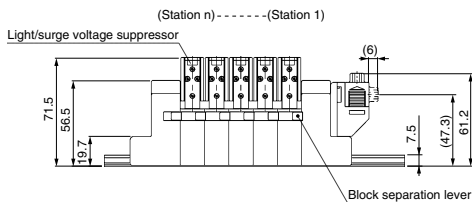
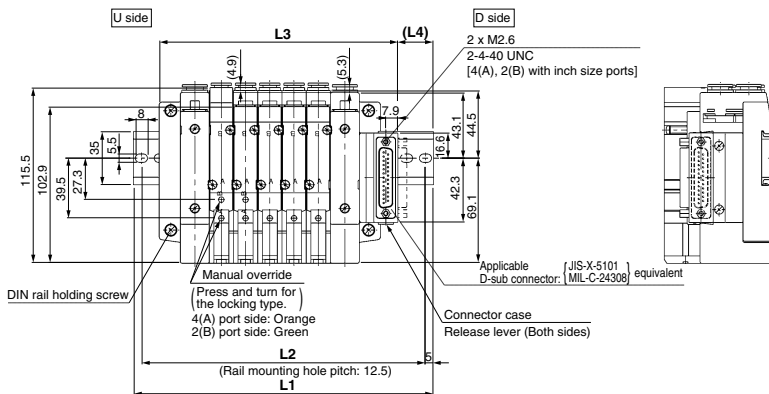
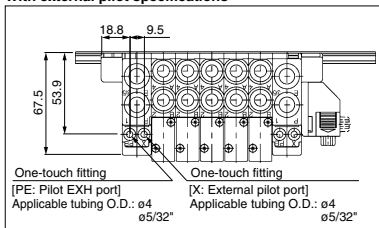

L Dimension

n	2	3	4	5	6	7	8	9	10	11	12	13	14	15	16	17	18	19	20
L1	148	160.5	173	198	210.5	223	235.5	260.5	273	285.5	310.5	323	335.5	348	373	385.5	398	423	435.5
L2	137.5	150	162.5	187.5	200	212.5	225	250	262.5	275	300	312.5	325	337.5	362.5	375	387.5	412.5	425
L3	109.5	125.5	141.5	157.5	173.5	189.5	205.5	221.5	237.5	253.5	269.5	285.5	301.5	317.5	333.5	349.5	365.5	381.5	397.5
L4	22.5	20.5	19	23.5	21.5	20	18	22.5	21	19	23.5	22	20	18.5	23	21	19.5	24	22

n: Stations

**Dimensions: Series 10-SV1000 for D-sub Connector**

• Tie-rod base manifold: 10-SS5V1-10FD<sub>2</sub> - [Stations] <sup>U</sup><sub>B</sub> (R)- C3, N1 C4, N3 C6, N7 (-D)

• When P, E port outlets are indicated on the U side or D side, the P, E ports on the opposite side are plugged.  
 • External pilot port positions are the same as P, E port outlet positions.

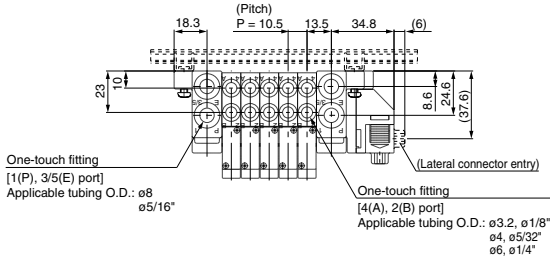

With external pilot specifications

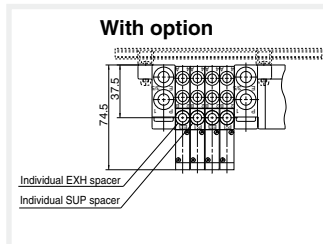
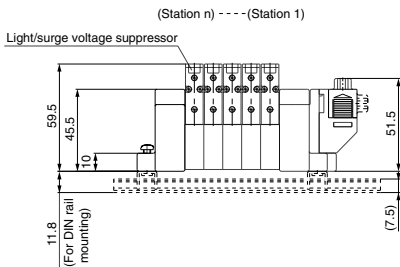
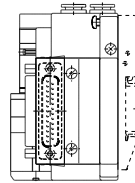
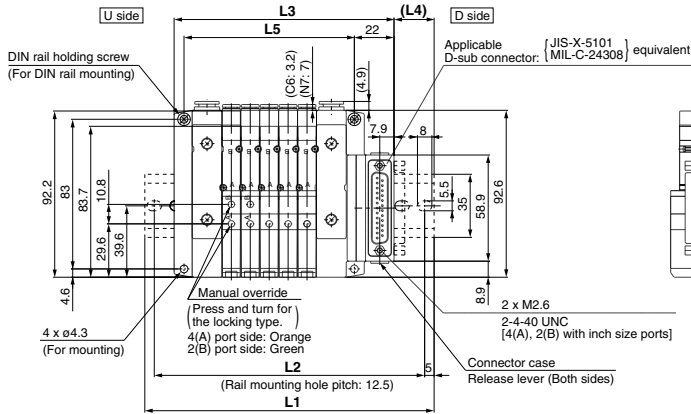
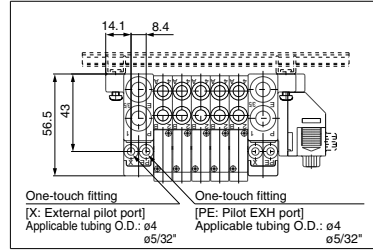

**L Dimension**

L	n	2	3	4	5	6	7	8	9	10	11	12	13	14	15	16	17	18	19	20
L1	123	135.5	148	160.5	173	173	185.5	198	210.5	223	235.5	235.5	248	260.5	273	285.5	298	310.5	310.5	
L2	112.5	125	137.5	150	162.5	162.5	175	187.5	200	212.5	225	225	237.5	250	262.5	275	287.5	300	300	
L3	90.5	101	111.5	122	132.5	143	153.5	164	174.5	185	195.5	206	216.5	227	237.5	248	258.5	269	279.5	
L4	19.5	20.5	21.5	22.5	23.5	18	19	20	21	22	23	18	19	20	21	22	23	24	18.5	
L5	63	73.5	84	94.5	105	115.5	126	136.5	147	157.5	168	178.9	189	199.5	210	220.5	231	241.5	252	

n: Stations

- Directional Control Valves
- Air Cylinders
- Rotary Actuators
- Air Grippers
- Air Preparation Equipment
- Modular F. R.
- Pressure Control Equipment
- Fittings & Tubing
- Flow Control Equipment
- Pressure Switches/ Pressure Sensors

Dimensions: Series 10-SV2000 for D-sub Connector

• Tie-rod base manifold: 10-SS5V2-10FD<sub>2</sub> - Stations U<sub>D</sub> (R) - C4, N3 C6, N7 C8, N9 (-D)

• When P, E port outlets are indicated on the U side or D side, the P, E ports on the opposite side are plugged.  
 • External pilot port positions are the same as P, E port outlet positions.

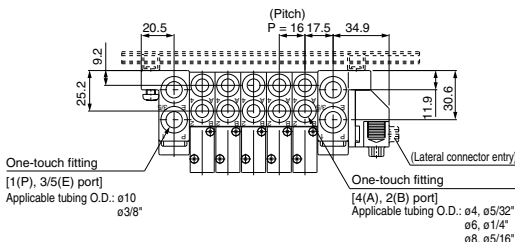

With external pilot specifications

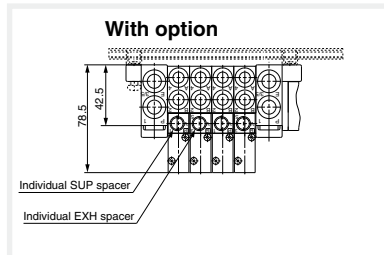
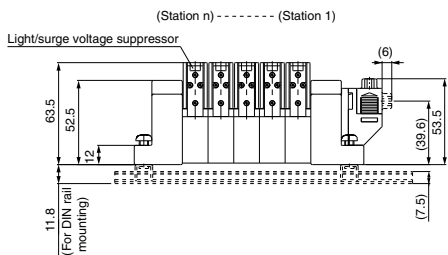
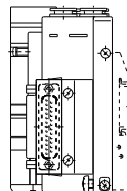
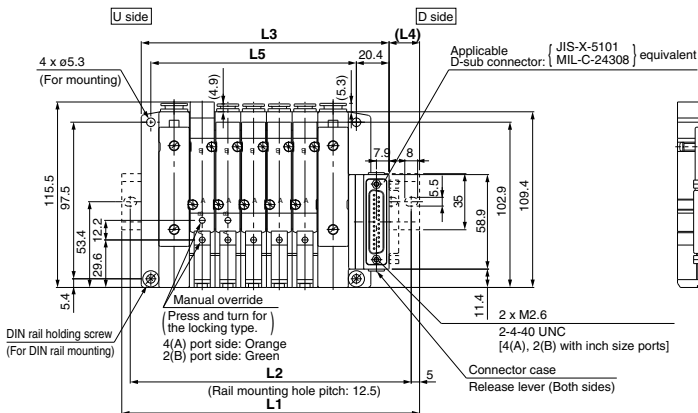
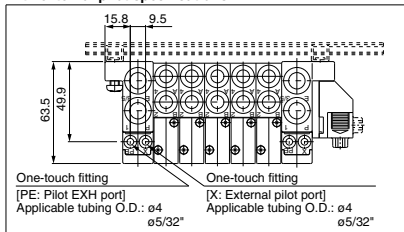

L Dimension

n	2	3	4	5	6	7	8	9	10	11	12	13	14	15	16	17	18	19	20
L1	135.5	160.5	173	185.5	210.5	223	235.5	248	273	285.5	298	323	335.5	348	360.5	385.5	398	410.5	435.5
L2	125	150	162.5	175	200	212.5	225	237.5	262.5	275	287.5	312.5	325	337.5	350	375	387.5	400	425
L3	106.4	122.4	138.4	154.4	170.4	186.4	202.4	218.4	234.4	250.4	266.4	282.4	298.4	314.4	330.4	346.4	362.4	378.4	394.4
L4	17.5	22	20.5	18.5	23	21.5	19.5	18	22.5	20.5	19	23.5	21.5	20	18	22.5	21	19	23.5
L5	80	96	112	128	144	160	176	192	208	224	240	256	272	288	304	320	336	352	368

**Dimensions: Series 10-SV3000 for D-sub Connector**

• Tie-rod base manifold: 10-SS5V3-10FD $\frac{1}{2}$ - [Stations]  $\frac{U}{B}$  (R)- C6, N7  
C8, N9  
C10, N11 (-D)

• When P, E port outlets are indicated on the U side or D side, the P, E ports on the opposite side are plugged.  
• External pilot port positions are the same as P, E port outlet positions.

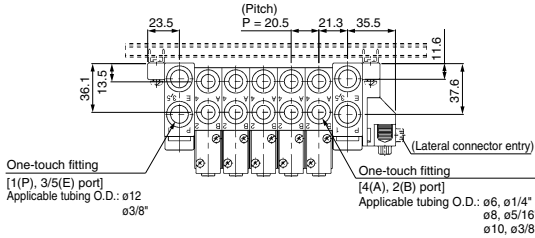

With external pilot specifications

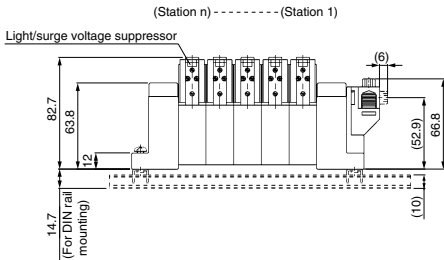
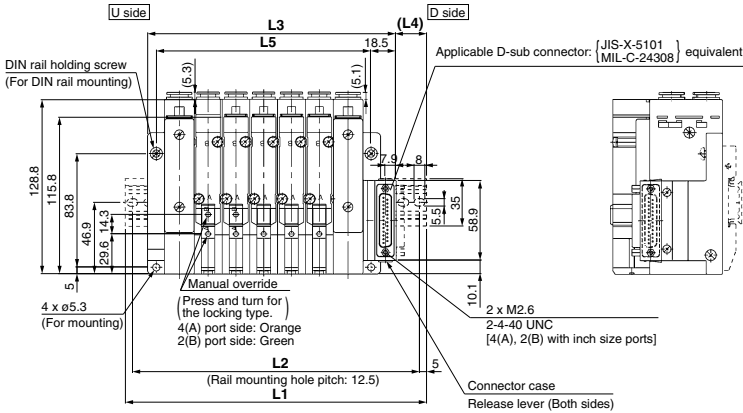
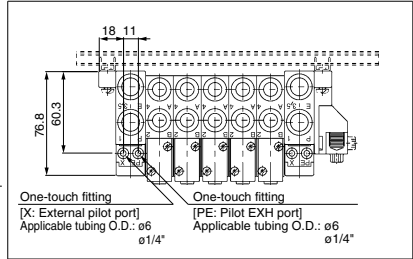

With option

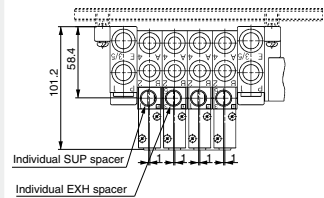

**L Dimension**

n	2	3	4	5	6	7	8	9	10	11	12	13	14	15	16	17	18	19	20
L1	160.5	173	198	223	235.5	260.5	285.5	298	323	348	360.5	385.5	398	423	448	460.5	485.5	510.5	523
L2	150	162.5	187.5	212.5	225	250	275	287.5	312.5	337.5	350	375	387.5	412.5	437.5	450	475	500	512.5
L3	122	142.5	163	183.5	204	224.5	245	265.5	286	306.5	327	347.5	368	388.5	409	429.5	450	470.5	491
L4	22.5	18.5	20.5	23	19	21	23.5	19.5	21.5	24	20	22	18	20.5	22.5	18.5	21	23	19
L5	97	117.5	138	158.5	179	199.5	220	240.5	261	281.5	302	322.5	343	363.5	384	404.5	425	445.5	466

Directional Control Valves  
Air Cylinders  
Rotary Actuators  
Air Grippers  
Air Preparation Equipment  
Modular F. R.  
Pressure Control Equipment  
Fittings & Tubing  
Flow Control Equipment  
Pressure Switches/ Pressure Sensors





# Flat Ribbon Cable Connector

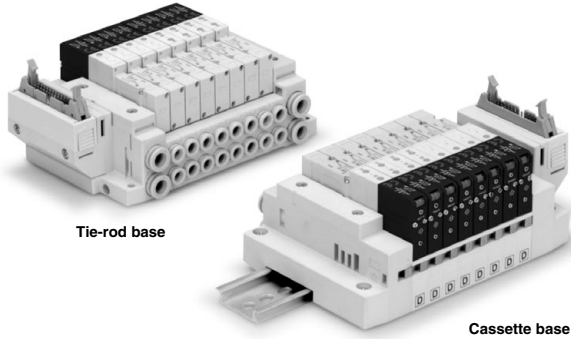

Tie-rod base

Cassette base

Applicable series	Cassette base manifold <b>10-SV1000/10-SV2000</b>
	Tie-rod base manifold <b>10-SV1000/10-SV2000/10-SV3000/10-SV4000</b>
<ul style="list-style-type: none"> <li>· Number of connectors: 26, 20, 10 pins</li> <li>· With strain relief</li> <li>· Conforming to MIL-C-83503</li> </ul>	

Directional  
Control Valves

Air Cylinders

Rotary Actuators

Air Grippers

Air Preparation  
Equipment

Modular F. R.

Pressure Control  
Equipment

Fittings & Tubing

Flow Control  
Equipment

Pressure Switches/  
Pressure Sensors

# Series 10-SV

Flat Ribbon Cable Connector



## How to Order

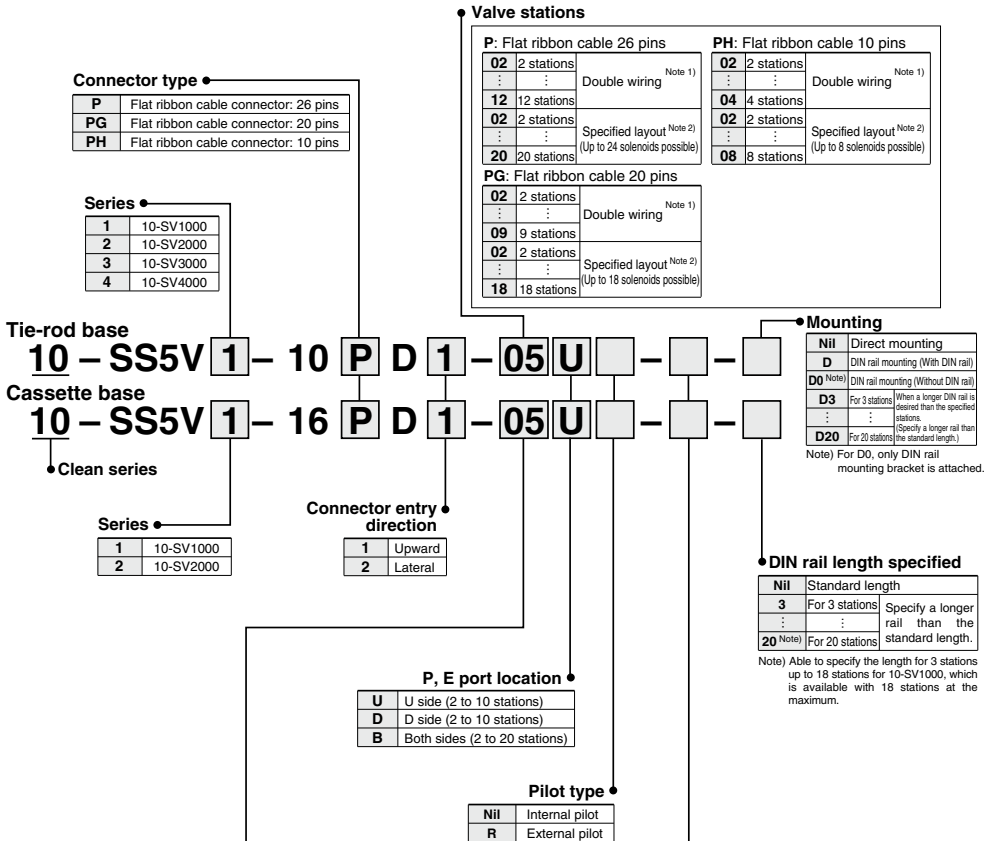

### Valve stations

Series 10-SV1000

<b>P: Flat ribbon cable 26 pins</b>			<b>PH: Flat ribbon cable 10 pins</b>		
<b>02</b>	2 stations	Double wiring <small>Note 1)</small>	<b>02</b>	2 stations	Double wiring <small>Note 1)</small>
...	...		...	...	
<b>09</b>	9 stations	Specified layout <small>Note 2)</small> (Up to 18 solenoids possible)	<b>04</b>	4 stations	Specified layout <small>Note 2)</small> (Up to 8 solenoids possible)
...	...		...	...	
<b>18</b>	18 stations	Specified layout <small>Note 2)</small> (Up to 18 solenoids possible)	<b>08</b>	8 stations	Specified layout <small>Note 2)</small> (Up to 8 solenoids possible)
...	...		...	...	
<b>PG: Flat ribbon cable 20 pins</b>					
<b>02</b>	2 stations	Double wiring <small>Note 1)</small>			
...	...				
<b>09</b>	9 stations	Specified layout <small>Note 2)</small> (Up to 18 solenoids possible)			
...	...				
<b>18</b>	18 stations	Specified layout <small>Note 2)</small> (Up to 18 solenoids possible)			
...	...				

Note 1) Double wiring: Single, double, 3 position and 4 position solenoid valves can be used on all manifold stations. Use of a single solenoid will result in an unused control signal. If this is not desired, order with a specified layout.

### Series 10-SV2000

<b>P: Flat ribbon cable 26 pins</b>			<b>PH: Flat ribbon cable 10 pins</b>		
<b>02</b>	2 stations	Double wiring <small>Note 1)</small>	<b>02</b>	2 stations	Double wiring <small>Note 1)</small>
...	...		...	...	
<b>12</b>	12 stations	Specified layout <small>Note 2)</small> (Up to 24 solenoids possible)	<b>04</b>	4 stations	Specified layout <small>Note 2)</small> (Up to 8 solenoids possible)
...	...		...	...	
<b>20</b>	20 stations	Specified layout <small>Note 2)</small> (Up to 24 solenoids possible)	<b>08</b>	8 stations	Specified layout <small>Note 2)</small> (Up to 8 solenoids possible)
...	...		...	...	
<b>PG: Flat ribbon cable 20 pins</b>					
<b>02</b>	2 stations	Double wiring <small>Note 1)</small>			
...	...				
<b>09</b>	9 stations	Specified layout <small>Note 2)</small> (Up to 18 solenoids possible)			
...	...				
<b>18</b>	18 stations	Specified layout <small>Note 2)</small> (Up to 18 solenoids possible)			
...	...				

Note 2) Specified layout: Indicate wiring specifications on the manifold specification sheet. (Note that double, 3 and 4 position valves cannot be used where single solenoid wiring has been specified.)

## How to Order Valve Manifold Assembly

### Ordering example (10-SV1000)

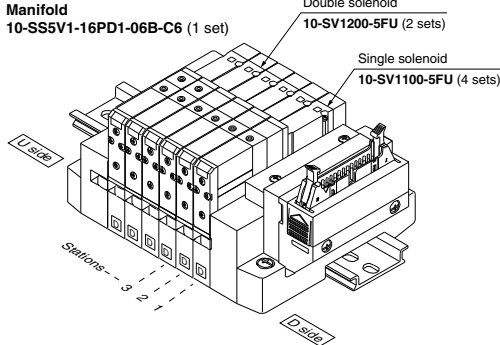

10-SS5V1-16PD1-06B-C6.....1 set (Manifold part no.)  
 \* 10-SV1100-5FU.....4 sets (Single solenoid part no.)  
 \* 10-SV1200-5FU.....2 sets (Double solenoid part no.)

## How to Order Solenoid Valve

**10 - SV 1 1 0 0** - **5 F** - (Note)

### Clean series

#### Series

1	10-SV1000
2	10-SV2000
3	10-SV3000
4	10-SV4000

#### Actuation type

1	2 position single solenoid
2	2 position double solenoid
3	3 position closed center
4	3 position exhaust center
5	3 position pressure center
A	4 position dual 3 port valve: N.C./N.C.
B	4 position dual 3 port valve: N.O./N.O.
C	4 position dual 3 port valve: N.C./N.O.

\* 4 position dual 3 port valves are applicable to the 10-SV1000 and 10-SV2000 series only.

#### Pilot type

Nil	Internal pilot
R	External pilot

\* External pilot specifications are not available for 4 position dual 3 port valves.

#### Rated voltage

5	24 VDC
6	12 VDC

#### Back pressure check valve

Nil	None
K	Built-in

\* The built-in back pressure check valve type is applicable to the 10-SV1000 series only.  
 \* The product with back pressure check valve is not available for 3 position solenoid valves.  
 (Note) Refer to the Specific Product Precautions 2 on page 274.

(Note) Available with manifold block for station additions. Refer to the WEB catalog.

#### Made to Order

Nil	—
X90	Main valve fluororubber (Refer to page 272.)

#### Manual override

Nil: Non-locking push type

D: Push-turn locking slotted type

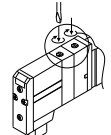
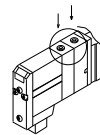

#### Light/surge voltage suppressor

U	With light/surge voltage suppressor
R	With surge voltage suppressor

### A, B port size (Metric)

Symbol	A, B port	P, E port	Applicable series
C3	ø3.2 One-touch fitting	ø8 One-touch fitting	10-SV1000
C4	ø4 One-touch fitting		
C6	ø6 One-touch fitting		
C4	ø4 One-touch fitting	ø10 One-touch fitting	10-SV2000
C6	ø6 One-touch fitting		
C8	ø8 One-touch fitting		
C6	ø6 One-touch fitting	ø12 One-touch fitting	10-SV3000
C8	ø8 One-touch fitting		
C10	ø10 One-touch fitting		
C8	ø8 One-touch fitting	ø12 One-touch fitting	10-SV4000
C10	ø10 One-touch fitting		
C12	ø12 One-touch fitting		
O2	Rc 1/4	Rc 3/8	10-SV4000
O3	Rc 3/8		
O2F	G 1/4		
O3F	G 3/8	G 3/8	
M	Mixed		

### A, B port size (Inch)

Symbol	A, B port	P, E port	Applicable series
N1	ø1/8" One-touch fitting	ø5/16" One-touch fitting	10-SV1000
N3	ø5/32" One-touch fitting		
N7	ø1/4" One-touch fitting		
N3	ø5/32" One-touch fitting	ø3/8" One-touch fitting	10-SV2000
N7	ø1/4" One-touch fitting		
N9	ø5/16" One-touch fitting		
N7	ø1/4" One-touch fitting	ø3/8" One-touch fitting	10-SV3000
N9	ø5/16" One-touch fitting		
N11	ø3/8" One-touch fitting		
N9	ø5/16" One-touch fitting	ø3/8" One-touch fitting	10-SV4000
N11	ø3/8" One-touch fitting		
O2N	NPT 1/4		
O3N	NPT 3/8	NPTF 3/8	10-SV4000
O2T	NPTF 1/4		
O3T	NPTF 3/8		
M	Mixed		

\* For mixed specifications (M), indicate separately on the manifold specification sheet.

\* External pilot type (R) X, PE port sizes are ø4 (metric), ø5/32" (inch) for the 10-SV1000/2000 series and ø6 (metric), ø1/4" (inch) for the 10-SV3000/4000 series.

Directional Control Valves  
 Air Cylinders  
 Rotary Actuators  
 Air Grippers  
 Air Preparation Equipment  
 Modular F. R.  
 Pressure Control Equipment  
 Fittings & Tubing  
 Flow Control Equipment  
 Pressure Switches/Pressure Sensors

## Manifold Electrical Wiring

**10P/16P flat ribbon cable type (26 pins)**

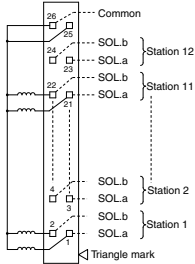

-This circuit is for the double wiring specification with up to 12 stations. Since the usable number of solenoids differs depending on the manifold type, refer to the table below. For single solenoids, connect to SOL.A. Furthermore, when wiring is specified on the manifold specification sheet, connections are made without skipping any connectors, and signals A for single and A, B for double are in order 1 → 2 → 3 → 4, etc.  
 -Stations are counted from the D side (connector side) as the 1st one.  
 -Since terminal numbers are not indicated on the flat ribbon cable, use the triangle mark as a reference for wiring.  
 -Since solenoid valves do not have polarity, either the +COM or -COM can be used.

**Usable no. of solenoids**

Model	Max. no. of solenoids
Type 10, Tie-rod base	24
10-SV1000 to 10-SV4000	
Type 16, Cassette base	18
10-SV1000 to 10-SV2000	

**10PG/16PG flat ribbon cable type (20 pins)**

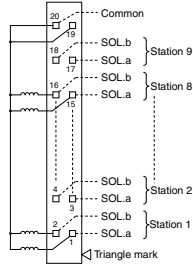

-This circuit is for the double wiring specification with up to 9 stations. Since the usable number of solenoids differs depending on the manifold type, refer to the table below. For single solenoids, connect to SOL.A. Furthermore, when wiring is specified on the manifold specification sheet, connections are made without skipping any connectors, and signals A for single and A, B for double are in order 1 → 2 → 3 → 4, etc.  
 -Stations are counted from the D side (connector side) as the 1st one.  
 -Since terminal numbers are not indicated on the flat ribbon cable, use the triangle mark as a reference for wiring.  
 -Since solenoid valves do not have polarity, either the +COM or -COM can be used.

**Usable no. of solenoids**

Model	Max. no. of solenoids
Type 10, Tie-rod base	18
10-SV1000 to 10-SV4000	
Type 16, Cassette base	18
10-SV1000 to 10-SV2000	

**10PH/16PH flat ribbon cable type (10 pins)**

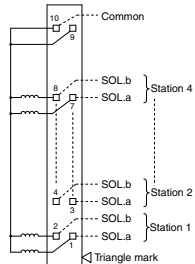

-This circuit is for the double wiring specification with up to 4 stations. Since the usable number of solenoids differs depending on the manifold type, refer to the table below. For single solenoids, connect to SOL.A. Furthermore, when wiring is specified on the manifold specification sheet, connections are made without skipping any connectors, and signals A for single and A, B for double are in order 1 → 2 → 3 → 4, etc.  
 -Stations are counted from the D side (connector side) as the 1st one.  
 -Since terminal numbers are not indicated on the flat ribbon cable, use the triangle mark as a reference for wiring.  
 -Since solenoid valves do not have polarity, either the +COM or -COM can be used.

**Usable no. of solenoids**

Model	Max. no. of solenoids
Type 10, Tie-rod base	8
10-SV1000 to 10-SV4000	
Type 16, Cassette base	8
10-SV1000 to 10-SV2000	

**Dimensions: Series 10-SV1000 for Flat Ribbon Cable**

- **Cassette base manifold: 10-SS5V1-16<sup>P</sup><sub>PH</sub> D<sub>1</sub> - [Stations] U<sub>D</sub> (R) - C3, N1  
C4, N3  
C6, N7**

• When P, E port outlets are indicated on the U side or D side, the P, E ports on the opposite side are plugged.  
• External pilot port positions are the same as P, E port outlet positions.

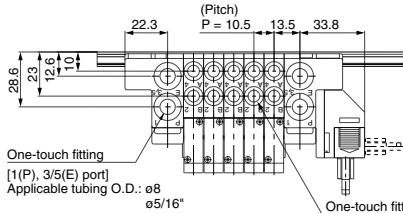

**With external pilot specifications**

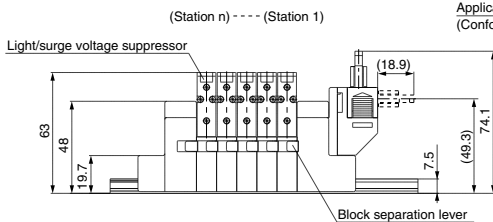
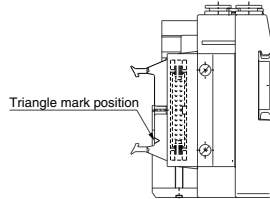
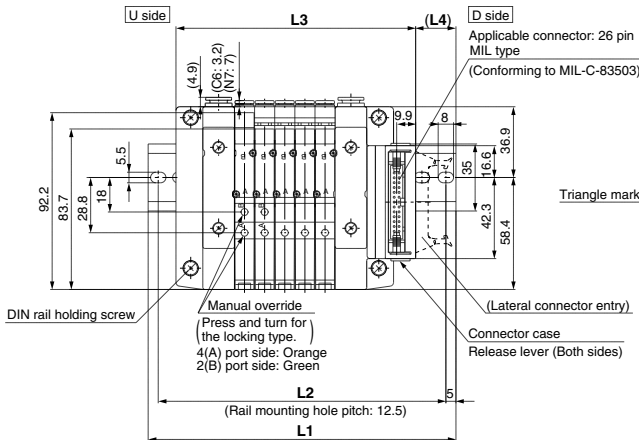
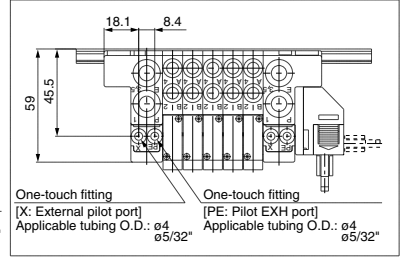

Applicable connector: 20 pin MIL type (Conforming to MIL-C-83503)

Applicable connector: 10 pin MIL type (Conforming to MIL-C-83503)

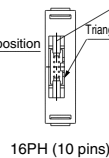
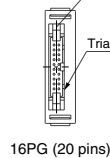

Refer to page 244 (for D-sub connector) for dimensions with individual SUP/EXH spacer.

**L Dimension**

n	2	3	4	5	6	7	8	9	10	11	12	13	14	15	16	17	18
L1	135.5	135.5	148	160.5	173	185.5	198	198	210.5	223	235.5	248	260.5	260.5	273	285.5	298
L2	125	125	137.5	150	162.5	175	187.5	187.5	200	212.5	225	237.5	250	250	262.5	275	287.5
L3	93.5	104	114.5	125	135.5	146	156.5	167	177.5	188	198.5	209	219.5	230	240.5	251	261.5
L4	24.5	19	20	21	22	23	24	19	20	21	22	23	24	18.5	19.5	20.5	21.5

n: Stations

**Dimensions: Series 10-SV2000 for Flat Ribbon Cable**

- **Cassette base manifold: 10-SS5V2-16<sup>P</sup><sub>PH</sub> D<sub>2</sub> - [Stations] U<sub>D</sub> (R) - C4, N3  
C6, N7  
C8, N9**

When P, E port outlets are indicated on the U side or D side, the P, E ports on the opposite side are plugged.  
External pilot port positions are the same as P, E port outlet positions.

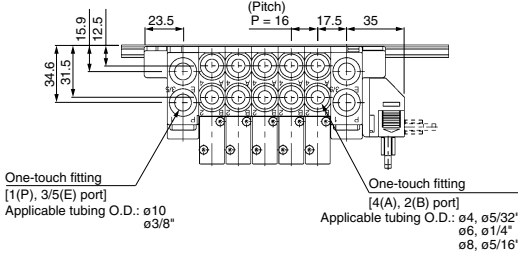

**With external pilot specifications**

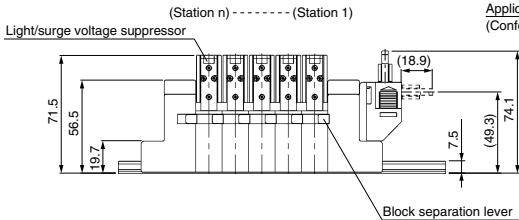
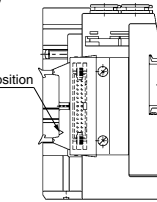
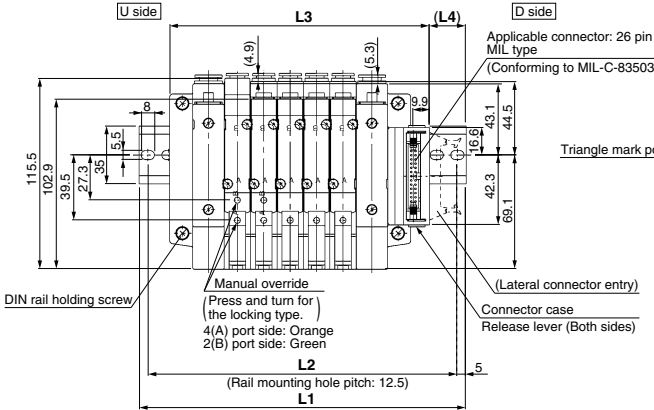
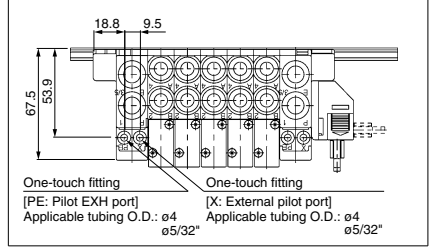

Applicable connector: 20 pin MIL type (Conforming to MIL-C-83503)      Applicable connector: 10 pin MIL type (Conforming to MIL-C-83503)

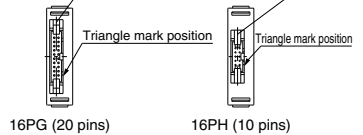

Refer to page 245 (for D-sub connector) for dimensions with individual SUP/EXH spacer.

**L Dimension**

n	2	3	4	5	6	7	8	9	10	11	12	13	14	15	16	17	18	19	20
L1	148	160.5	173	198	210.5	223	235.5	260.5	273	285.5	310.5	323	335.5	348	373	385.5	398	423	435.5
L2	137.5	150	162.5	187.5	200	212.5	225	250	262.5	275	300	312.5	325	337.5	362.5	375	387.5	412.5	425
L3	109.5	125.5	141.5	157.5	173.5	189.5	205.5	221.5	237.5	253.5	269.5	285.5	301.5	317.5	333.5	349.5	365.5	381.5	397.5
L4	22.5	21	19	23.5	22	20	18.5	23	21	19.5	24	22	20.5	18.5	23	21.5	19.5	24	22.5







**Dimensions: Series 10-SV3000 for Flat Ribbon Cable**

• Tie-rod base manifold: 10-SS5V3-10<sup>P</sup><sub>PH</sub> D<sub>2</sub>- Stations<sub>B</sub> U (R) - C6, N7  
C8, N9  
C10, N11 (-D)

• When P, E port outlets are indicated on the U side or D side, the P, E ports on the opposite side are plugged.  
• External pilot port positions are the same as P, E port outlet positions.

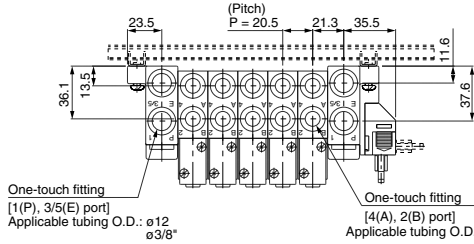

With external pilot specifications

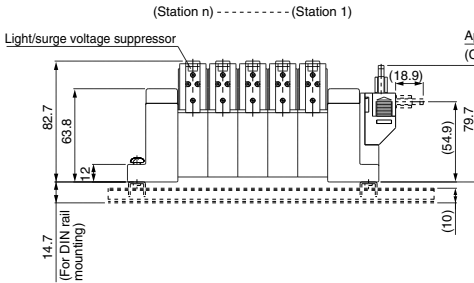
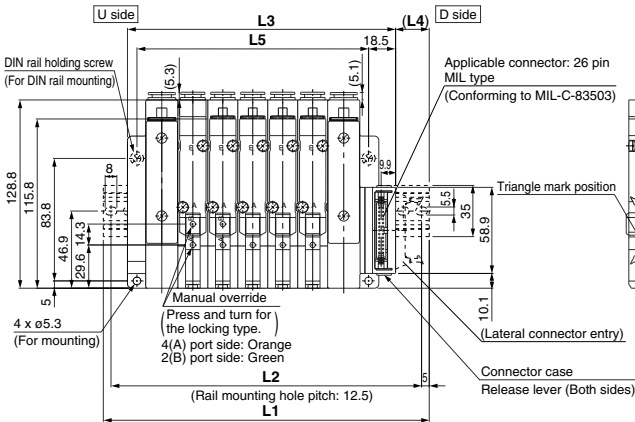
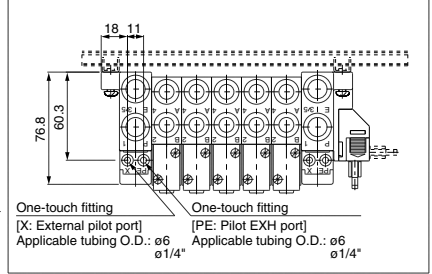

Applicable connector: 20 pin MIL type (Conforming to MIL-C-83503)

Applicable connector: 10 pin MIL type (Conforming to MIL-C-83503)

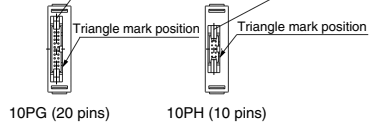

Refer to page 248 (for D-sub connector) for dimensions with individual SUP/EXH spacer.

**L Dimension**

n	2	3	4	5	6	7	8	9	10	11	12	13	14	15	16	17	18	19	20
L1	160.5	173	198	223	235.5	260.5	285.5	298	323	348	360.5	385.5	398	423	448	460.5	485.5	510.5	523
L2	150	162.5	187.5	212.5	225	250	275	287.5	312.5	337.5	350	375	387.5	412.5	437.5	450	475	500	512.5
L3	122	142.5	163	183.5	204	224.5	245	265.5	286	306.5	327	347.5	368	388.5	409	429.5	450	470.5	491
L4	22.5	18.5	21	23	19	21.5	23.5	19.5	22	24	20	22.5	18.5	20.5	23	19	21	23.5	19.5
L5	97	117.5	138	158.5	179	199.5	220	240.5	261	281.5	302	322.5	343	363.5	384	404.5	425	445.5	466

n: Stations

Directional Control Valves  
Air Cylinders  
Rotary Actuators  
Air Grippers  
Air Preparation Equipment  
Modular F. R.  
Pressure Control Equipment  
Fittings & Tubing  
Flow Control Equipment  
Pressure Switches/ Pressure Sensors



# Series 10-SV

# Manifold Option (Common for Type 16 and 10)

## Relay output module

By adding a relay output module to the 10-SV series manifold, devices up to 110 VAC, 3 A (large type solenoid valves, etc.) can be controlled together with 10-SV series valves.

### How to Order

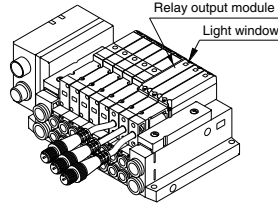
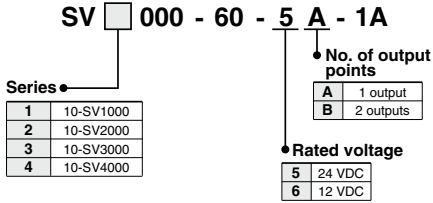

### Relay output module specifications

Item	Specifications			
No. of output points	1 output [connector with lead wire (M12)]		2 outputs [connector with lead wire (M12)]	
Output type	<p>Contact type ("a" contact)</p>		<p>Contact type ("a" contact)</p>	
Load voltage	110 VAC	30 VDC	110 VAC	30 VDC
Load current	3 A	3 A	0.3 A	1 A
Indicator light	Red		A side: Red B side: Green	
Enclosure	Based on IP67 (IEC60529)			
Current consumption	20 mA or less			
Polarity	Non-polar			
Weight (g)	48			

## Y type connector

Used to branch a two output relay output module to two separate systems.

### How to Order

**EX500 - ACY00 - S**

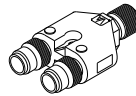

### Relay output module and Y type connector wiring example

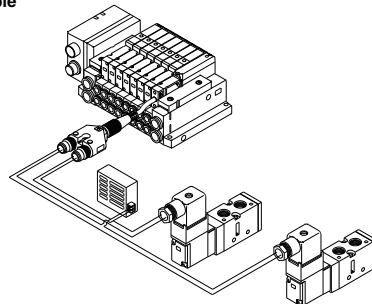
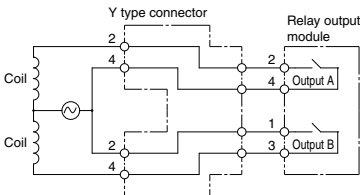

## Manifold Option

### ■ Blanking plate assembly

Used in situations where valves will be added in the future.

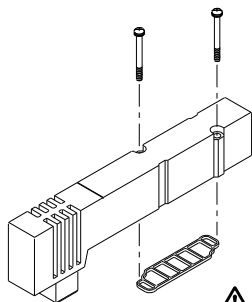

### ⚠ Caution

Mounting screw tightening torques

Series	Blanking plate assembly part no.
10-SV1000	SV1000-67-1A
10-SV2000	SV2000-67-1A
10-SV3000	SV3000-67-1A
10-SV4000	SV4000-67-1A

M2: 0.15 N·m

M3: 0.6 N·m

M4: 1.4 N·m

### ■ SUP/EXH block disk

[SUP block disk]

By placing a SUP block disk in a manifold valve's pressure supply passage, two different high and low pressures can be supplied to one manifold.

[EXH block disk]

By installing an EXH block disk in a manifold valve's exhaust passage, the valve's exhaust can be separated so that it will not affect other valves. It can also be used on a manifold with mixed positive pressure and vacuum. (Two pieces are required to block EXH on both sides. However, the 10-SV1000 and 2000 series type 10 manifolds require only one piece.)

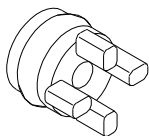

Type 16, Cassette base

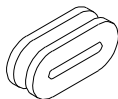

Type 10, Tie-rod base

Series	Manifold type	SUP block disk	EXH block disk
10-SV1000	10	SV1000-59-1A	SV1000-59-2A
	16	SX3000-77-1A	SX3000-77-1A
10-SV2000	10	SV2000-59-1A	SV2000-59-2A
	16	SV2000-59-3A	SV2000-59-3A
10-SV3000	10	SV3000-59-1A	SV3000-59-1A
10-SV4000	10	SY9000-57-1A	SY9000-57-1A

### ■ Label for block disk

These labels are attached to manifolds in which SUP and EXH block disks have been installed, in order to identify the installed locations. (Three sheets each included.)

#### SV1000 - 74 - 1A

Label for SUP block disk



Label for EXH block disk



Label for SUP/EXH block disk



\* When a block disk is concurrently ordered by specifying on the manifold specification sheet, etc., a label will be stuck on the position where block disk is mounted.

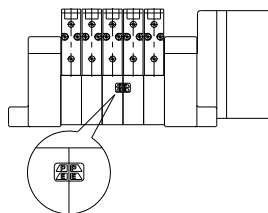

### ■ Plug

These are inserted in unused cylinder ports and P, E ports.

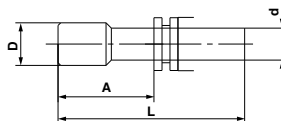

Applicable fitting size $d$	Model	A	L	D
$\phi 4$	10-KQP-04	16	32	$\phi 6$
$\phi 6$	10-KQP-06	18	35	$\phi 8$
$\phi 8$	10-KQP-08	20.5	39	$\phi 10$
$\phi 10$	10-KQP-10	22	43	$\phi 12$
$\phi 12$	10-KQP-12	24	44.5	$\phi 14$
$\phi 1/8"$	10-KQP-01	16	31.5	$\phi 5$
$\phi 5/32"$	10-KQP-03	16	32	$\phi 6$
$\phi 1/4"$	10-KQP-07	18	35	$\phi 8.5$
$\phi 5/16"$	10-KQP-09	20.5	39	$\phi 10$
$\phi 3/8"$	10-KQP-11	22	43	$\phi 11.5$

## Manifold Option

### ■Circular connector / Cable assembly (26 pins)

AXT100 – MC26 – □

Lead wire length

Part no.	L dimension
AXT100-MC26-015	1.5 m
AXT100-MC26-030	3 m
AXT100-MC26-050	5 m

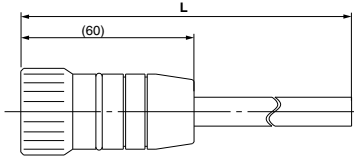

Plug terminal no.  
(Arrangement as seen from lead wire side)

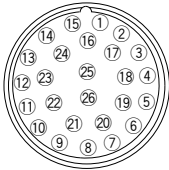

#### Circular connector cable assembly

Terminal no.

Terminal no.	Lead wire color	Dot marking
1	Black	None
2	Brown	None
3	Red	None
4	Orange	None
5	Yellow	None
6	Pink	None
7	Blue	None
8	Purple	White
9	Gray	Black
10	White	Black
11	White	Red
12	Yellow	Red
13	Orange	Red
14	Yellow	Black
15	Pink	Black
16	Blue	White
17	Purple	None
18	Gray	None
19	Orange	Black
20	Red	White
21	Brown	White
22	Pink	Red
23	Gray	Red
24	Black	White
25	White	None

Note) Terminal no. 26 is connected to 25 inside the connector.

### ■D-sub connector / Cable assembly (25 pins)

AXT100 – DS25 – □

Lead wire length

Part no.	L dimension
AXT100-DS25-015	1.5 m
AXT100-DS25-030	3 m
AXT100-DS25-050	5 m

When a commercially available connector is required, use a 25 pin female connector conforming to MIL-C-24308.

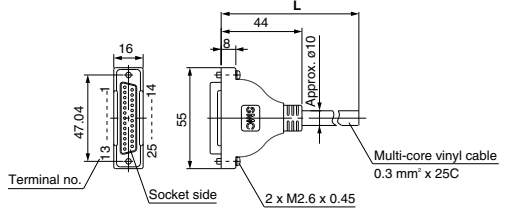

#### D-sub connector cable assembly

Terminal no.

Terminal no.	Lead wire color	Dot marking
1	Black	None
2	Brown	None
3	Red	None
4	Orange	None
5	Yellow	None
6	Pink	None
7	Blue	None
8	Purple	White
9	Gray	Black
10	White	Black
11	White	Red
12	Yellow	Red
13	Orange	Red
14	Yellow	Black
15	Pink	Black
16	Blue	White
17	Purple	None
18	Gray	None
19	Orange	Black
20	Red	White
21	Brown	White
22	Pink	Red
23	Gray	Red
24	Black	White
25	White	None

#### Circular connector, D-sub connector cable assembly

Electric characteristics

Item	Characteristics
Conductor resistance Ω/km, 20°C	65 or less
Withstand voltage VAC, 1 minute	1000
Insulation resistance MΩkm, 20°C	5 or less

Note) The minimum bending radius of each cable is 20 mm.

Directional Control Valves  
 Air Cylinders  
 Rotary Actuators  
 Air Grippers  
 Air Preparation Equipment  
 Modular F. R.  
 Pressure Control Equipment  
 Fittings & Tubing  
 Flow Control Equipment  
 Pressure Switches/ Pressure Sensors

## Manifold Option

### ■ Flat ribbon cable / Cable assembly

#### AXT100 – FC□ – □

Cable length (L)	10 pins	20 pins	26 pins
1.5 m	AXT100-FC10-1	AXT100-FC20-1	AXT100-FC26-1
3 m	AXT100-FC10-2	AXT100-FC20-2	AXT100-FC26-2
5 m	AXT100-FC10-3	AXT100-FC20-3	AXT100-FC26-3
Connector width (W)	17.2	30	37.5

\* For other commercial connectors, use a type with strain relief conforming to MIL-C-83503.

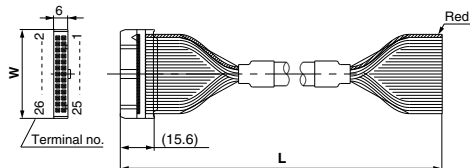

#### Example of connector manufacturers

- HIROSE ELECTRIC CO., LTD.
- Japan Aviation Electronics Industry, Limited
- 3M Japan Limited
- J.S.T. Mfg. Co., Ltd.
- Fujitsu Limited

### ■ 10-SV1000/2000 and EX500 series input unit

#### DIN rail dimensions and weights

#### VZ1000 – 11 – 1 – □

\* As for □, enter the number from the DIN rail dimensions table.

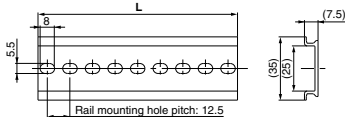

No.	0	1	2	3	4	5	6	7	8	9
L dimension	98	110.5	123	135.5	148	160.5	173	185.5	198	210.5
Weight (g)	17.6	19.9	22.1	24.4	26.6	28.9	31.1	33.4	35.6	37.9
No.	10	11	12	13	14	15	16	17	18	19
L dimension	223	235.5	248	260.5	273	285.5	298	310.5	323	335.5
Weight (g)	40.1	42.4	44.6	46.9	49.1	51.4	53.6	55.9	58.1	60.4
No.	20	21	22	23	24	25	26	27	28	29
L dimension	348	360.5	373	385.5	398	410.5	423	435.5	448	460.5
Weight (g)	62.5	64.9	67.1	69.4	71.6	73.9	76.1	78.4	80.6	82.9
No.	30	31	32	33	34	35	36	37	38	39
L dimension	473	485.5	498	510.5	523	535.5	548	560.5	573	585.5
Weight (g)	85.1	87.4	89.6	91.9	94.1	96.4	98.6	100.9	103.1	105.4
No.	40	41	42	43	44	45	46	47	48	49
L dimension	598	610.5	623	635.5	648	660.5	673	685.5	698	710.5
Weight (g)	107.6	109.9	112.1	114.4	116.6	118.9	121.1	123.4	125.6	127.9
No.	50	51	52	53	54	55	56	57	58	59
L dimension	723	735.5	748	760.5	773	785.5	798	810.5	823	835.5
Weight (g)	130.1	132.4	134.6	136.9	139.1	141.4	143.6	145.9	148.1	150.4
No.	60	61	62	63	64	65	66	67	68	69
L dimension	848	860.5	873	885.5	898	910.5	923	935.5	948	960.5
Weight (g)	152.6	154.9	157.1	159.4	161.6	163.9	166.1	168.4	170.6	172.9
No.	70	71								
L dimension	973	985.5								
Weight (g)	175.1	177.4								

### ■ 10-SV3000/4000 DIN rail dimensions and weights

#### VZ1000 – 11 – 4 – □

\* As for □, enter the number from the DIN rail dimensions table.

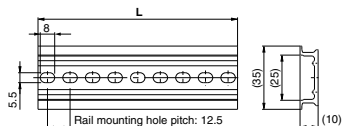

No.	0	1	2	3	4	5	6	7	8	9	10	11	12	13	14	15	16	17	18	19	20
L dimension	98	110.5	123	135.5	148	160.5	173	185.5	198	210.5	223	235.5	248	260.5	273	285.5	298	310.5	323	335.5	348
Weight (g)	24.8	28	31.1	34.3	37.4	40.6	43.8	46.9	50.1	53.3	56.4	59.6	62.7	65.9	69.1	72.2	75.4	78.6	81.7	84.9	88
No.	21	22	23	24	25	26	27	28	29	30	31	32	33	34	35	36	37	38	39	40	41
L dimension	360.5	373	385.5	398	410.5	423	435.5	448	460.5	473	485.5	498	510.5	523	535.5	548	560.5	573	585.5	598	610.5
Weight (g)	91.2	94.4	97.5	100.7	103.9	107	110.2	113.3	116.5	119.7	122.8	126	129.2	132.3	135.5	138.6	141.8	145	148.1	151.3	154.5
No.	42	43	44	45	46	47	48	49	50	51	52	53	54	55	56	57	58	59	60	61	62
L dimension	623	635.5	648	660.5	673	685.5	698	710.5	723	735.5	748	760.5	773	785.5	798	810.5	823	835.5	848	860.5	873
Weight (g)	157.6	160.8	163.9	167.1	170.3	173.4	176.6	179.8	182.9	186.1	189.2	192.4	195.6	198.7	201.9	205.1	208.2	211.4	214.5	217.7	220.9
No.	63	64	65	66	67	68	69	70	71												
L dimension	885.5	898	910.5	923	935.5	948	960.5	973	985.5												
Weight (g)	224	227.2	230.4	233.5	236.7	239.8	243	246.2	249.3												

## Manifold Option

### ■ Individual SUP spacer assembly

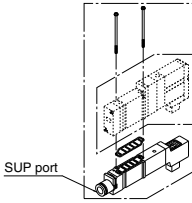

### ■ Individual EXH spacer assembly

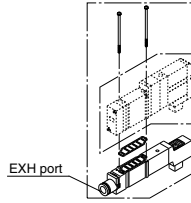

### How to order individual SUP/EXH spacer assembly

Series 10-SV1000

**SV1000** — **38** — **1A** — **C6**

● **Port size**

<b>C3</b>	ø3.2 One-touch fitting
<b>C4</b>	ø4 One-touch fitting
<b>C6</b>	ø6 One-touch fitting
<b>N1</b>	ø1/8" One-touch fitting
<b>N3</b>	ø5/32" One-touch fitting
<b>N7</b>	ø1/4" One-touch fitting

● **Spacer type**

<b>38</b>	Individual SUP spacer
<b>39</b>	Individual EXH spacer

Series 10-SV2000/10-SV3000/10-SV4000

**SV** **2** **000** — **38** — **1** **A**

● **Series**

<b>2</b>	10-SV2000
<b>3</b>	10-SV3000
<b>4</b>	10-SV4000

● **Thread type** (Note)

<b>Nil</b>	Rc
<b>F</b>	G
<b>N</b>	NPT
<b>T</b>	NPTF

Note) 10-SV2000/3000/4000 port size

Series	Port size
10-SV2000	1/8
10-SV3000	1/4
10-SV4000	

### Accessory

Series	Round head combination screw	Gasket
10-SV1000	SX3000-22-9 (M2 x 39.5)	SX3000-57-4
10-SV2000	SV2000-21-6 (M3 x 46)	SY5000-11-15
10-SV3000	SV3000-21-3 (M4 x 53)	SY7000-11-11
10-SV4000	SV2000-21-5 (M3 x 60)	SY9000-11-2

Directional Control Valves

Air Cylinders

Rotary Actuators

Air Grippers

Air Preparation Equipment

Modular F. R.

Pressure Control Equipment

Fittings & Tubing

Flow Control Equipment

Pressure Switches/ Pressure Sensors



# Series 10-SV1000/2000/3000/4000

Single Unit/Sub-plate Type  
[IP67 Compliant]

## How to Order

**10 - SV 1 1 00** - **5 W1 U D** -  -  -

**Clean series**

**Series**

1	10-SV1000
2	10-SV2000
3	10-SV3000
4	10-SV4000

**Actuation type**

**10-SV1000/2000/3000/4000**

2 position single

1 (A)4 2(B)  
(EA)5 1 3(EB)  
(P)

2 position double

2 (A)4 2(B)  
(EA)5 1 3(EB)  
(P)

**Pilot type**

Nil	Internal pilot
R	External pilot

\* External pilot specifications are not available for 4 position dual 3 port valves.

**Rated voltage**

5	24 VDC
6	12 VDC

**Thread type**

Nil	Rc
F	G
N	NPT
T	NPTF

**Port size**

Symbol	Port size	Applicable series
Nil	Without sub-plate	
01	1/8	10-SV1000
02	1/4	10-SV2000
03	3/8	10-SV3000
04	1/2	10-SV4000

**Made to Order**

Nil	—
X90	Main valve fluororubber (Refer to page 272.)

**Manual override**

Nil	Non-locking push type
D	Push-turn locking slotted type

**Light/Surge voltage suppressor**

U	With light/surge voltage suppressor
R	With surge voltage suppressor

**M12 waterproof connector**

Symbol	Cable length (mm)
W1	300
W2	500
W3	1000
W4	2000
W7	5000

**10-SV1000/2000/3000**

3 position closed center

3 (A)4 2(B)  
(EA)5 1 3(EB)  
(P)

3 position exhaust center

4 (A)4 2(B)  
(EA)5 1 3(EB)  
(P)

3 position pressure center

5 (A)4 2(B)  
(EA)5 1 3(EB)  
(P)

**10-SV4000**

3 position closed center

3 (A)4 2(B)  
(EA)5 1 3(EB)  
(P)

3 position exhaust center

4 (A)4 2(B)  
(EA)5 1 3(EB)  
(P)

3 position pressure center

5 (A)4 2(B)  
(EA)5 1 3(EB)  
(P)

**10-SV1000**

4 position dual 3 port valve: N.C./N.C.

A 4(A) 2(B)  
5(EA) 1(P) 3(EB)

B 4(A) 2(B)  
5(EA) 1(P) 3(EB)

C 4(A) 2(B)  
5(EA) 1(P) 3(EB)

**10-SV2000**

4 position dual 3 port valve: N.C./N.C.

A 4(A) 2(B)  
5(EA) 1(P) 3(EB)

B 4(A) 2(B)  
5(EA) 1(P) 3(EB)

C 4(A) 2(B)  
5(EA) 1(P) 3(EB)

\* 10-SV3000 and 4000 are not available with 4 position dual 3 port valves.

### 10-SV Series Solenoid Valve Specifications



<b>Fluid</b>		Air
<b>Internal pilot operating pressure range (MPa)</b>	2 position single	0.15 to 0.7
	4 position dual 3 port valve	
	2 position double	
<b>External pilot operating pressure range (MPa)</b>	3 position	0.1 to 0.7
	Operating pressure range	
	2 position single, double	
<b>Ambient and fluid temperature (°C)</b>	3 position	-100 kPa to 0.7
		0.25 to 0.7
<b>Max. operating frequency (Hz)</b>		-10 to 50 (No freezing. Refer to page 680.)
<b>Manual override</b>	2 position single, double	5
	4 position dual 3 port valve	3
	3 position	
<b>Pilot exhaust method</b>		Non-locking push type
<b>Lubrication</b>	Internal pilot	Push-turn locking slotted type
	External pilot	Main/Pilot valve common exhaust
<b>Mounting orientation</b>		Pilot valve individual exhaust
<b>Lubrication</b>		Not required
<b>Mounting orientation</b>		Unrestricted
<b>Impact/Vibration resistance (m/s<sup>2</sup>)</b>		150/30 (8.3 to 2000 Hz)
<b>Enclosure</b>		IP67 (Based on IEC60529)
<b>Electrical entry</b>		M12 waterproof connector
<b>Coil rated voltage</b>		24 VDC, 12 VDC
<b>Allowable voltage fluctuation</b>		±10% of rated voltage
<b>Power consumption (W)</b>		0.6 (With light: 0.65)
<b>Surge voltage suppressor</b>		Zener diode
<b>Indicator light</b>		LED

Note) Impact resistance: No malfunction occurred when it was tested with a drop tester in the axial direction and at right angles to the main valve and armature in both energized and deenergized states once for each condition. (Default settings)  
 Vibration resistance: No malfunction occurred in a one-sweep test between 45 and 2000 Hz. Test was performed in both energized and de-energized states in the axial direction and at right angles to the main valve and armature. (Default settings)

#### Response Time

Actuation type	Response time (ms) (at the pressure of 0.5 MPa)			
	10-SV1000	10-SV2000	10-SV3000	10-SV4000
2 position single	11 or less	25 or less	28 or less	40 or less
2 position double	10 or less	17 or less	26 or less	40 or less
3 position	18 or less	29 or less	32 or less	82 or less
4 position dual 3 port valve	15 or less	33 or less	—	—

Note) Based on dynamic performance test, JIS B 8375-1981. (Coil temperature: 20°C, at rated voltage)

#### M12 Waterproof Connector Wiring Specifications

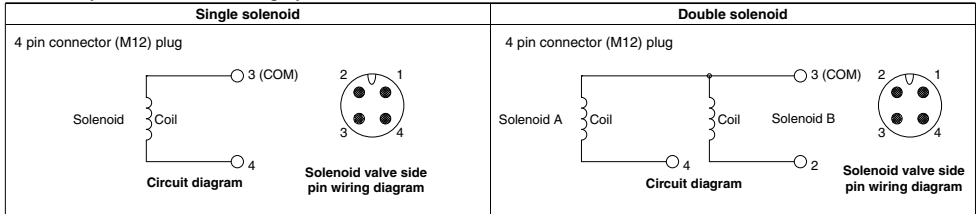

Note) Solenoid valves have no polarity.

#### Connection (Female Side) Connector Cable

As the parts are not supplied from SMC, refer to the application examples listed in the below. (For detail such as catalog availability, etc., please contact each manufacturer.)

Connector size	Number of pins	Manufacturer	Applicable series example
M12	4	Correns Corporation	VA-4D
		OMRON Corporation	XS2
		Azbil Corporation	PA5-41
		HIROSE ELECTRIC CO., LTD.	HR24
		DDK Ltd.	CM01-8DP4S

\* This connector is a female connector for ① relay output module and ② single unit/sub-plate.

Single Unit/Sub-plate Type **10-SV**

**Flow Rate Characteristics/Weight**

**10-SV1000**

Valve model	Actuation type		Port size	Flow rate characteristics <sup>Note 1)</sup>						Weight (g) <sup>Note 2)</sup>	
				1 → 4/2 (P → A/B)			4/2 → 5/3 (A/B → EA/EB)			M12 waterproof connector (Cable length 300 mm)	
				C[dm <sup>3</sup> /(s·bar)]	b	Cv	C[dm <sup>3</sup> /(s·bar)]	b	Cv		
10-SV1□00-□-01□	2 position	Single	1/8	1.0	0.30	0.24	1.1	0.30	0.26	123 (88)	
		Double								128 (93)	
	3 position	Closed center		0.77	0.28	0.18	0.85	0.30	0.19	130 (95)	
		Exhaust center		1.2 [0.51]	0.24 [0.45]	0.29 [0.14]	0.89	0.47	0.24		
		Pressure center		0.68	0.35	0.18	1.1	0.39	0.29		
	4 position dual	N.C./N.C.		1/8	0.87	0.31	0.23	0.77	0.44	0.21	128 (93)
		N.O./N.O.									

Note 1) [ ]: Denotes normal position. Note 2) ( ): Denotes without sub-plate.

**10-SV2000**

Valve model	Actuation type		Port size	Flow rate characteristics <sup>Note 1)</sup>						Weight (g) <sup>Note 2)</sup>	
				1 → 4/2 (P → A/B)			4/2 → 5/3 (A/B → EA/EB)			M12 waterproof connector (Cable length 300 mm)	
				C[dm <sup>3</sup> /(s·bar)]	b	Cv	C[dm <sup>3</sup> /(s·bar)]	b	Cv		
10-SV2□00-□-02□	2 position	Single	1/4	2.4	0.41	0.64	2.8	0.29	0.66	159 (96)	
		Double								163 (100)	
	3 position	Closed center		1.8	0.47	0.50	1.8	0.40	0.47	168 (105)	
		Exhaust center		3.3 [0.84]	0.36 [0.60]	0.85 [0.28]	3.0 [1.2]	0.33 [0.48]	0.72 [0.37]		
		Pressure center		2.2	0.40	0.55	2.6	0.31	0.60		
	4 position dual	N.C./N.C.		1/4	2.7	0.24	0.57	2.3	0.36	0.54	163 (100)
		N.O./N.O.									

Note 1) [ ]: Denotes normal position. Note 2) ( ): Denotes without sub-plate.

**10-SV3000**

Valve model	Actuation type		Port size	Flow rate characteristics <sup>Note 1)</sup>						Weight (g) <sup>Note 2)</sup>
				1 → 4/2 (P → A/B)			4/2 → 5/3 (A/B → EA/EB)			M12 waterproof connector (Cable length 300 mm)
				C[dm <sup>3</sup> /(s·bar)]	b	Cv	C[dm <sup>3</sup> /(s·bar)]	b	Cv	
10-SV3□00-□-02□	2 position	Single	1/4	4.1	0.41	1.1	4.1	0.29	1.0	250 (121)
		Double								253 (124)
	3 position	Closed center		3.0	0.43	0.80	2.6	0.41	0.72	26 (132)
		Exhaust center		2.6	0.42	0.71	4.7 [1.7]	0.35 [0.48]	1.1 [0.49]	
		Pressure center		5.3 [2.3]	0.39 [0.49]	1.3 [0.65]	2.2	0.49	0.63	
10-SV3□00-□-03□	2 position	Single	3/8	4.9	0.29	1.2	4.5	0.27	1.1	235
		Double								238
	3 position	Closed center		3.0	0.40	0.80	2.6	0.45	0.73	246
		Exhaust center		2.6	0.42	0.71	4.8 [1.7]	0.35 [0.48]	1.1 [0.34]	
		Pressure center		5.3 [2.3]	0.31 [0.51]	1.3 [0.64]	2.3	0.45	0.66	

Note 1) [ ]: Denotes normal position. Note 2) ( ): Denotes without sub-plate.

**10-SV4000**

Valve model	Actuation type		Port size	Flow rate characteristics <sup>Note 1)</sup>						Weight (g) <sup>Note 2)</sup>
				1 → 4/2 (P → A/B)			4/2 → 5/3 (A/B → EA/EB)			M12 waterproof connector (Cable length 300 mm)
				C[dm <sup>3</sup> /(s·bar)]	b	Cv	C[dm <sup>3</sup> /(s·bar)]	b	Cv	
10-SV4□00-□-03□	2 position	Single	3/8	7.9	0.34	2.0	9.6	0.43	2.5	505 (208)
		Double								509 (212)
	3 position	Closed center		7.5	0.33	1.8	7.3	0.30	1.7	530 (233)
		Exhaust center		7.2	0.34	1.7	13 [4.0]	0.23 [0.41]	2.8 [0.95]	
		Pressure center		12 [3.3]	0.26 [0.41]	2.8 [0.84]	6.7	0.40	1.9	
10-SV4□00-□-04□	2 position	Single	1/2	8.0	0.48	2.2	10	0.29	2.5	484
		Double								488
	3 position	Closed center		7.6	0.32	1.8	7.3	0.32	1.8	509
		Exhaust center		7.3	0.42	2.0	13 [4.7]	0.32 [0.54]	3.6 [1.5]	
		Pressure center		12 [3.3]	0.33 [0.51]	3.3 [0.94]	7.4	0.33	1.9	

Note 1) [ ]: Denotes normal position. Note 2) ( ): Denotes without sub-plate.

**Dimensions: Series 10-SV1000**

**2 position single/double, 4 position dual 3 port [M12 waterproof connector type]**

10-SV1□00(R)-□W□□-01□

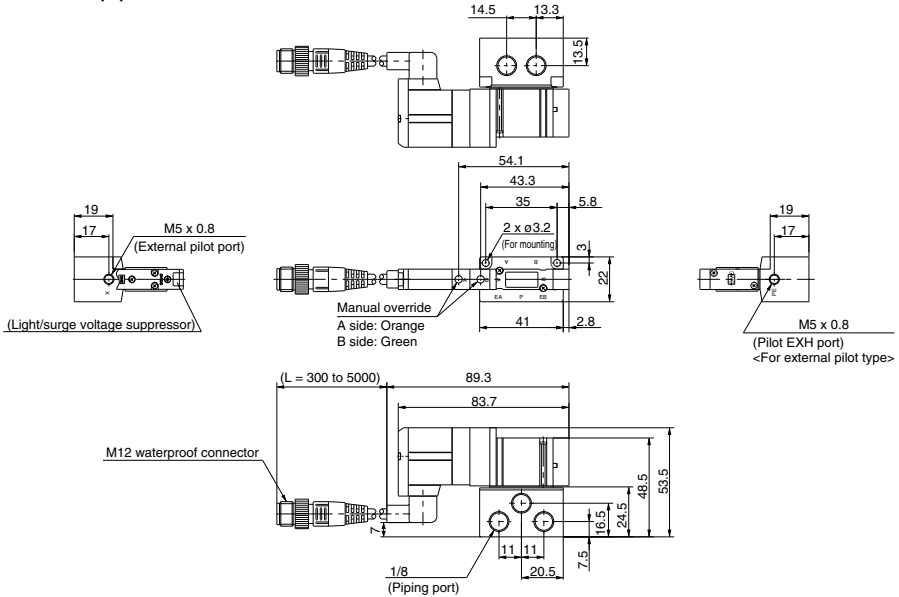

**3 position closed center / exhaust center / pressure center [M12 waterproof connector type]**

10-SV1□00(R)-□W□□-01□

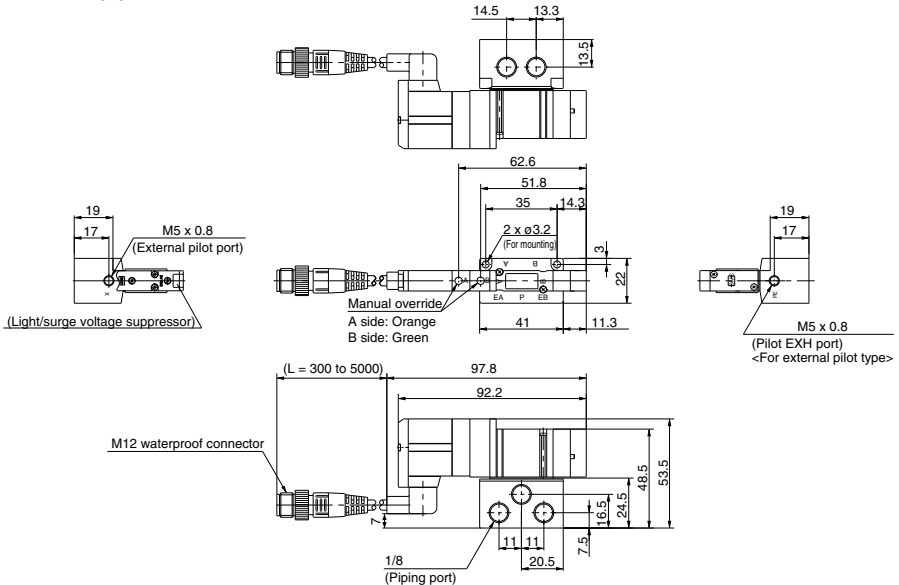

Directional Control Valves

Air Cylinders

Rotary Actuators

Air Grippers

Air Preparation Equipment

Modular F. R.

Pressure Control Equipment

Fittings & Tubing

Flow Control Equipment

Pressure Switches/ Pressure Sensors

**Dimensions: Series 10-SV2000**

**2 position single/double, 4 position dual 3 port [M12 waterproof connector type]**

**10-SV2□00(R)-□W□□-02□**

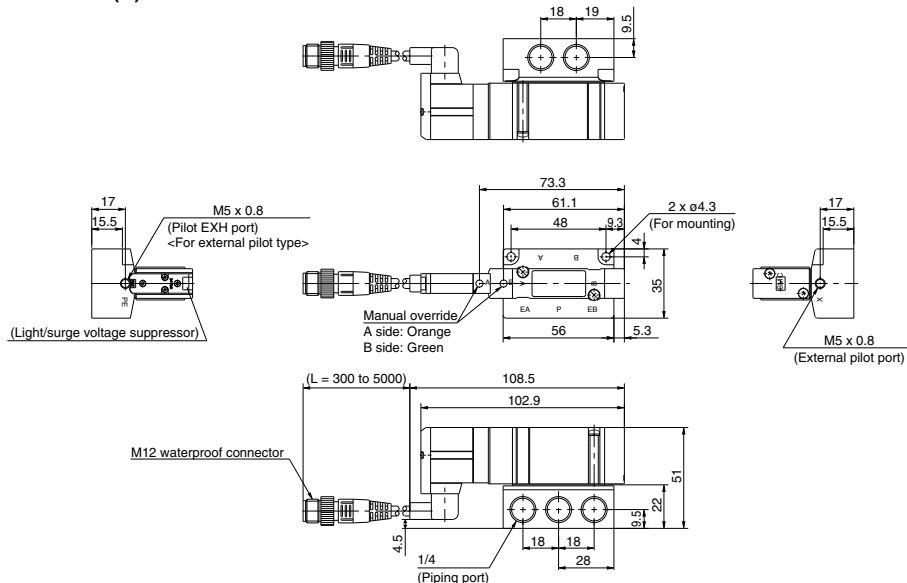

**3 position closed center / exhaust center / pressure center [M12 waterproof connector type]**

**10-SV2□00(R)-□W□□-02□**

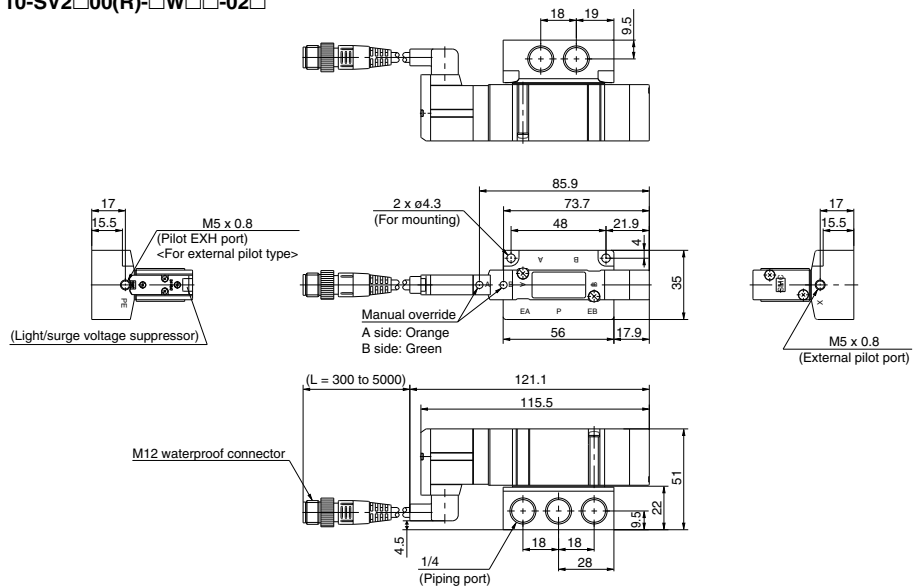



**Dimensions: Series 10-SV4000**

**2 position single/double [M12 waterproof connector type]**

10-SV4□00(R)-□W□□-03, 04□

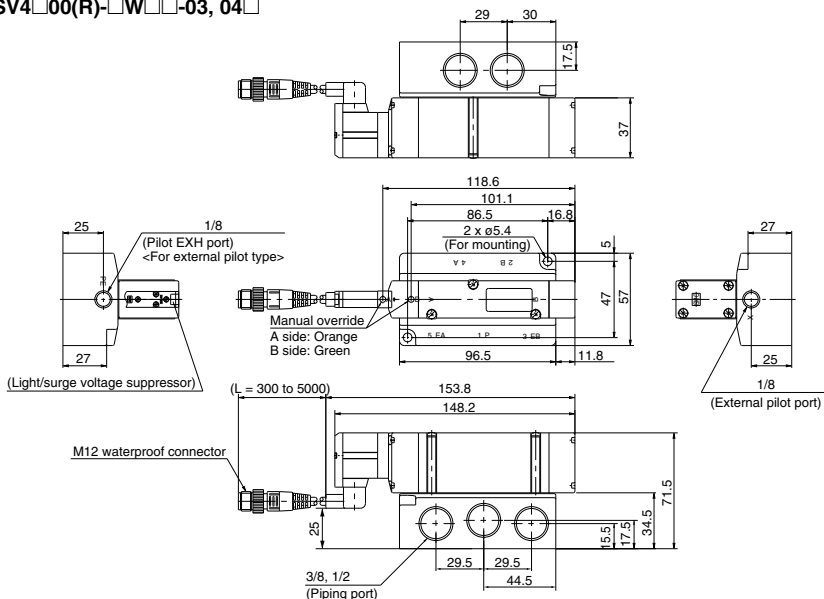

**3 position closed center / exhaust center / pressure center [M12 waterproof connector type]**

10-SV4□00(R)-□W□□-03, 04□

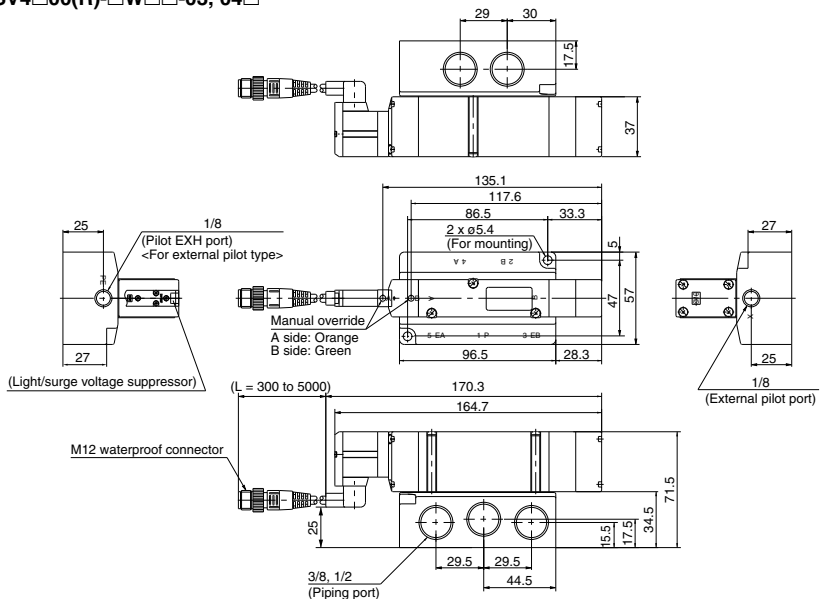





## ⚠ Specific Product Precautions 1

Be sure to read this before handling.

### ⚠ Warning

#### Operating Environment

1. Do not use valves in atmospheres of corrosive gases, chemicals, salt water, water, steam, or where there is direct contact with any of these.
2. Products compliant with IP65 and IP67 enclosures (Based on IEC529) are protected against dust and water, however, these products cannot be used in water.
3. Products compliant with IP65 and IP67 enclosures satisfy the specifications by mounting each product properly. Be sure to read the Specific Product Precautions for each product.

### ⚠ Warning

#### Manual Override Operation

Handle carefully, as connected equipment can be actuated through manual override operation.

##### ■ Non-locking push type

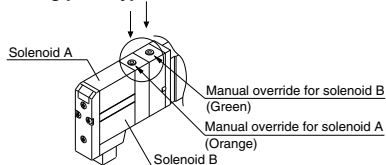

##### ■ Push-turn locking slotted type

While pressing the lock down, turn it in the direction of the arrow. If it does not turn, it can be operated the same way as the non-locking type.

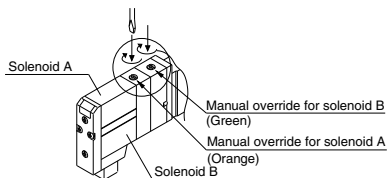

### ⚠ Caution

When locking the manual override with the push-turn locking slotted type, be sure to push the lock down before turning it. Turning without first pushing it down can cause damage to the manual override and other trouble such as air leakage, etc.

### ⚠ Caution

#### Exhaust Throttle

With the 10-SV series, pilot valve and main valve share a common exhaust inside the valve. Therefore, do not block the exhaust port when installing the piping.

### ⚠ Caution

#### Series 10-SV Used as a 3 Port Valve

##### When using a 5 port valve as a 3 port valve

The 10-SV series can be used as normally closed (N.C.) or normally open (N.O.) 3 port valves by closing one of the cylinder ports (A or B) with a plug. However, they should be used with the exhaust ports kept open. They are convenient at times when a double solenoid type 3 port valve is required.

Plug position		B port	A port
Actuation		N.C.	N.O.
Number of solenoids	Single		
	Double		

### ⚠ Caution

#### Light/Surge Voltage Suppressor

Solenoid valves have no polarity.  
Light/Surge voltage suppressor

Single solenoid

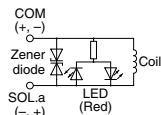

Double solenoid, 3 position type

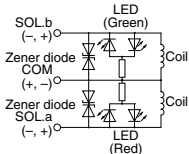

##### Surge voltage suppressor

Single solenoid

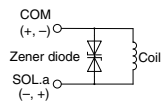

Double solenoid, 3 position type

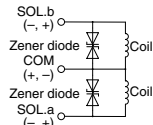

### ⚠ Caution

#### Light Indication

When equipped with light and surge voltage suppressor, the light window turns red when solenoid A is energized, and it turns green when solenoid B is energized.

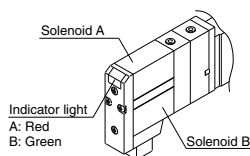

## ⚠ Specific Product Precautions 2

Be sure to read this before handling.

### ⚠ Caution

#### Valve Replacement, Adding/Removing Manifold Stations

Replacing solenoid valves and adding/removing manifold stations may cause external leakage. So, it is recommended to ask SMC for repair. When repair work is performed by the user, the user shall be responsible for the work since SMC cannot perform the inspection or check.

### ⚠ Caution

#### Connector Entry Directions

Connector entry directions for D-sub connectors and flat ribbon cables can be changed. To change the connector's entry direction, press the levers on both sides of the connector, take it off, and change the direction as shown in the drawing. Since lead wire assemblies are attached to the connector, excessive pulling or twisting can cause broken wires or other trouble. Also, take precautions so that lead wires are not caught and pinched when installing the connector.

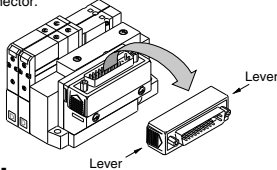

### ⚠ Caution

#### Manifold Mounting

There will be slight variations in the width of manifold blocks due to tolerance for the stacking manifold type.

As the manifold is made up of a combination of manifold blocks, there will be an error due to accumulated tolerance between the actual pitch dimensions of the mounting holes used to secure the manifold and the values stated in the catalog. Keep this in mind when increasing the number of stations.

#### Manifold Block Width Tolerance Chart

Series	Block width tolerance
SS5V1-(W)10□ series	±0.15 mm
SS5V2-(W)10□ series	±0.2 mm
SS5V3-(W)10□ series	±0.15 mm
SS5V4-(W)10□ series	±0.15 mm

### ⚠ Caution

#### How to Order Manifold

The letter "S" or "D" is indicated on manifold blocks for the 10-SV series as shown below. This indication refers to the type of substrate assembly (single wiring or double wiring) inside the manifold blocks.

When the manifold specification sheet does not include wiring specifications, all stations will be double wiring specification (D). In this case, single and double solenoid valves can be mounted in any position, but when a single valve is used, there will be an unused control signal. To avoid this, indicate positions of manifold blocks for single wiring specification (S) and double wiring specification (D) on the manifold specification sheet. (Note that double, 3 or 4 position valves cannot be used for manifolds blocks with single wiring specification (S).)

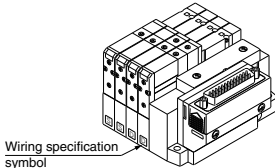

### ⚠ Caution

#### Substrate Assemblies inside Manifolds

Substrate assemblies inside of manifolds cannot be taken apart. Attempting to do so may damage parts.

### ⚠ Caution

#### One-touch Fittings

##### 1. Tubing attachment/detachment for One-touch fittings

###### (1) Attaching tubing

(1) Take a tubing with no flaws on its periphery and cut it off at a right angle. When cutting the tubing, use tube cutters TK-1, 2 or 3. Do not use pinchers, nippers or scissors, etc. If cutting is done with tools other than tube cutters, the tubing may be cut diagonally or become flattened, etc., making a secure installation impossible, and causing problems such as the tubing coming out after installation or air leakage.

Allow some extra length in the tubing.

(2) Grasp the tubing, slowly push it straight (0 to 5°) into the One-touch fitting until it comes to a stop.

(3) After inserting the tubing, pull on it lightly to confirm that it will not come out. If it is not installed securely all the way into the fitting, this can cause problems such as air leakage or the tubing coming out.

###### (2) Detaching tubing

(1) Push in the release button sufficiently, pushing its collar equally around the circumference.

(2) Pull out the tubing while holding down the release button so that it does not come out. If the release button is not pressed down sufficiently, there will be increased bite on the tubing and it will become more difficult to pull it out.

(3) When the removed tubing is to be used again, cut off the portion which had been secured before reusing it. If the some portion of the tubing is reused, this can cause trouble such as air leakage or difficulty in removing the tubing.

### ⚠ Caution

#### Other Tubing Brands

##### 1. When using tubing other than SMC brand tubing, confirm that the following specifications are satisfied with respect to the outside diameter tolerance of the tubing.

- 1) Nylon tubing within  $\pm 0.1$  mm
- 2) Soft nylon tubing within  $\pm 0.1$  mm
- 3) Polyurethane tubing within  $+0.15$  mm  
within  $-0.2$  mm

Do not use tubing which do not meet these outside diameter tolerances. It may not be possible to connect them, or they may cause other trouble, such as air leakage or the tubing coming out after connection.

### ⚠ Caution

#### Built-in Back Pressure Check Valve Type

1. Valves with built-in back pressure check valve are to protect the back pressure inside a valve. For this reason, use caution the valves with external pilot specifications cannot be pressurized from exhaust port [3/5(E)]. As compared with the types which do not integrate the back pressure check valve, C value of the flow rate characteristics goes down. For details, please contact SMC.

2. Do not switch valves when A or B port is open to the atmosphere, or while the actuators and air operated equipment are in operation. The back pressure prevention seal may be peeled off, which may cause air leakage or malfunctions. Use caution especially when performing a trial operation or maintenance work.

## ⚠ Specific Product Precautions 3

Be sure to read this before handling.

**EX500/EX250/EX260/EX120**

### ⚠ Warning

1. **These products are intended for use in general factory automation equipment.**  
Avoid using these products in machinery/equipment which affects human safety, and in cases where malfunction or failure can result in extensive damage.
2. **Do not use in an explosive atmosphere, environment with inflammable gases, or corrosive atmosphere.**  
This can cause injury or fire, etc.
3. **Work such as transporting, installing, piping, wiring, operation, control and maintenance should be performed by personnel with specialized knowledge.**  
There is a danger of electrocution, injury or fire, etc.
4. **Install an external emergency stop circuit that can promptly stop operation and shut off the power supply.**
5. **Do not remodel these products, as there is a danger of injury and damage.**
6. **Do not wipe the product with chemicals, etc.**

### ⚠ Caution

1. **Read the operation manual carefully, strictly observe the precautions and operate within the range of the specifications.**
2. **Do not drop these products or submit them to strong impacts. This can cause damage, failure or malfunction, etc.**
3. **In locations with poor electrical conditions, take steps to ensure a steady flow of the rated power supply. Use of a voltage outside of the specifications can cause malfunction, damage to the unit, electrocution or fire, etc.**
4. **Do not touch connector terminals or internal substrates when current is being supplied. There is a danger of malfunction, damage to the unit or electrocution if connector terminals or internal substrates are touched when current is being supplied.**  
Be sure that the power supply is OFF when adding or removing manifold valves or input blocks, etc., or when connecting or disconnecting connectors.
5. **Operate at an ambient temperature that is within the specifications. Even when the ambient temperature range is within the specifications, do not use in locations where there are rapid temperature changes.**
6. **Keep wire scraps and other extraneous material from getting inside these products. This can cause fire, failure or malfunction, etc.**
7. **Give consideration to the operating environment depending on the type of enclosure being used.**  
To achieve IP65 or IP67 protection, provide appropriate wiring between all units using electrical wiring cables, communication connectors and cables with M12 connectors. Also, provide waterproof caps when there are unused ports, and perform proper mounting of input units, input blocks, SI units and manifold valves, etc. Provide a cover or other protection for applications in which there is constant exposure to water.
8. **Obey the proper tightening torque.**  
There is a possibility of damaging threads if tightening exceeds the tightening torque range.
9. **Provide adequate protection when operating in locations such as the following:**
  - Where noise is generated by static electricity, etc.
  - Where there is a strong electric field
  - Where there is a danger of exposure to radiation
  - When in close proximity to power supply lines

### ⚠ Caution

10. **When these products are installed in equipment, provide adequate protection against noise by using noise filters, etc.**
11. **Since these products are components that are used after installation in other equipment, the customer should confirm conformity to EMC directives for the finished product.**
12. **Do not remove the name plate.**
13. **Perform periodic inspections and confirm normal operation. It may otherwise be impossible to guarantee safety due to unexpected malfunction or erroneous operation.**
14. **Do not use in places where there are cyclic temperature changes.**  
In case that the cyclic temperature is beyond normal temperature changes, the inside the product is likely to be adversely affected.
15. **Do not use in direct sunlight.**  
Do not use in direct sunlight. It may cause malfunction or damage.
16. **Do not use in places where there is radiated heat around it.**  
Such a place is likely to cause malfunction.

### Safety Instructions for Power Supply

#### ⚠ Caution

1. **Operation is possible with a single power supply or a separate power supply. However, be sure to provide two wiring systems (one for solenoid valves, and one for input and control units).**
2. **Use the following UL approved products for DC power supply combinations.**
  - 1) **Controlled voltage current circuit conforming to UL508**  
Circuit uses the secondary coil of an isolated transformer as the power supply, satisfying the following conditions.
    - Max. voltage (with no load): 30 Vrms (42.4 V peak) or less
    - Max. current: (1) 8 A or less (including shorts), and (2) When controlled by a circuit protector (fuse, etc.) with the following rating

No-load voltage (V peak)	Max. current rating
0 to 20 [V]	5.0
Over 20 [V] to 30 [V]	100
	Peak voltage value
  - 2) **A circuit (class 2 circuit) with maximum 30 Vrms (42.4 V peak) or less, and a power supply consisting of a class 2 power supply unit conforming to UL1310, or a class 2 transformer conforming to UL1585**

### Safety Instructions for Cable

#### ⚠ Caution

1. **Be careful of miswiring. This can cause malfunction, damage and fire in the unit.**
2. **To prevent noise and surge in signal lines, keep all wiring separate from power lines and high voltage lines. Otherwise, this can cause malfunction.**
3. **Check wiring insulation, as defective insulation can cause damage to the unit due to excessive voltage or current.**
4. **Do not bend or pull cables repeatedly, and do not place heavy objects on them or allow them to be pinched. This can cause broken lines.**

## ⚠ Specific Product Precautions 4

Be sure to read this before handling.

EX600

### Design/Selection

#### ⚠ Warning

- Use this product within the specification range.**  
Using beyond the specified range can cause fire, malfunction, or damage to the system.  
Confirm the specifications when operating.
- When using for an interlock circuit:**
  - Provide a multiple interlock system which is operated by another system (such as mechanical protection function).
  - Perform an inspection to check that it is working properly.

This may cause possible injury due to malfunction.

#### ⚠ Caution

- When applicable to UL, use a Class 2 power supply unit conforming to UL1310 for direct current power supply.**
- Use this product within the specified voltage range.**  
Using beyond the specified voltage range is likely to cause the units and connecting devices to be damaged or to malfunction.
- The power supply for the unit should be 0 V as the standard for both power supply for output as well as power supply for control/input.**

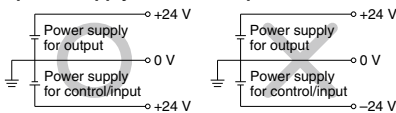

- Do not install a unit in a place where it can be used as a foothold.**  
Applying any excessive load such as stepping on the unit by mistake or placing a foot on it, will cause it to break.
- Keep the surrounding space free for maintenance.**  
When designing a system, take into consideration the amount of free space needed for performing maintenance.
- Do not remove the name plate.**  
Improper maintenance or incorrect use of operation manual can cause failure and malfunction. Also, there is a risk of losing conformity with safety standards.
- Beware of inrush current when the power supply is turned on.**  
Some connected loads can apply an initial charge current which will trigger the over current protection function, causing the unit to malfunction.

### Mounting

#### ⚠ Caution

- When handling and assembling units:**
  - Do not touch the sharp metal parts of the connector or plug.
  - Do not apply excessive force to the unit when disassembling.  
The connecting portions of the unit are firmly joined with seals.
  - When joining units, take care not to get fingers caught between units.  
Injury can result.
- Do not drop, bump, or apply excessive impact.**  
Otherwise, the unit can become damaged, malfunction, or fail to function.
- Observe the tightening torque range.**  
Tightening outside of the allowable torque range will likely damage the screw.  
IP67 cannot be guaranteed if the screws are not tightened to the specified torque.
- When lifting a large size manifold solenoid valve unit, take care to avoid causing stress to the valve connection joint.**  
The connection parts of the unit may be damaged.  
Because the unit may be heavy, carrying and installation should be performed by more than one operator to avoid strain or injury.
- When placing a manifold, mount it on a flat surface.**  
Torsion in the whole manifold can lead to trouble such as air leakage or defective insulation.

### Wiring

#### ⚠ Caution

- Confirm grounding to maintain the safety of the reduced wiring system and for anti-noise performance.**  
Provide a specific grounding as close to the unit as possible to minimize the distance to grounding.
- Avoid repeatedly bending or stretching the cable and applying a heavy object or force to it.**  
Wiring applying repeated bending and tensile stress to the cable can break the circuit.
- Avoid miswiring.**  
If miswired, there is a danger of malfunction or damage to the reduced wiring system.
- Do not wire while energizing the product.**  
There is a danger of malfunction or damage to the reduced wiring system or input/output equipment.
- Avoid wiring the power line and high pressure line in parallel.**  
Noise or surge produced by signal line resulting from the power line or high pressure line could cause malfunction.  
Wiring of the reduced wiring system or input/output device and the power line or high pressure line should be separated from each other.

Directional Control Valves

Air Cylinders

Rotary Actuators

Air Grippers

Air Preparation Equipment

Modular F. R.

Pressure Control Equipment

Fittings & Tubing

Flow Control Equipment

Pressure Switches/ Pressure Sensors

## ⚠ Specific Product Precautions 5

Be sure to read this before handling.

### EX600

#### Wiring

### ⚠ Caution

#### 6. Confirm the wiring insulation.

Defective insulation (contact with other circuits, improper insulation between terminals, etc.) may cause damage to the reduced wiring system or input/output device due to excessive voltage or current.

#### 7. When a reduced wiring system is installed in machinery/equipment, provide adequate protection against noise by using noise filters, etc.

Noise in signal lines may cause malfunction.

#### 8. When connecting wires of input/output device or Handheld Terminal, prevent water, solvent or oil from entering inside from the connector section.

This can cause damage, equipment failure or malfunction.

#### 9. Avoid wiring patterns in which excessive stress is applied to the connector.

This may cause malfunction or damage to the unit due to contact failure.

#### Operating Environment

### ⚠ Warning

#### 1. Do not use in an atmosphere containing an inflammable gas or explosive gas.

Use in such an atmosphere is likely to cause a fire or explosion. This system is not explosion-proof.

### ⚠ Caution

#### 1. Select the proper type of enclosure according to the environment of operation.

IP65/67 is achieved when the following conditions are met.

1) Provide appropriate wiring between all units using electrical wiring cables, communication connectors and cables with M12 connectors.

2) Suitable mounting of each unit and manifold valve.

3) Be sure to mount a seal cap on any unused connectors.

If using in an environment that is exposed to water splashes, please take measures such as using a cover.

When the enclosure is IP40, do not use in an operating environment or atmosphere where it may come in contact with corrosive gas, chemical agents, seawater, water, or water vapor. When connected to EX600-D□□E or EX600-D□□F, manifold enclosure is IP40.

Also, the Handheld Terminal conforms to IP20, so prevent foreign matter from entering inside, and water, solvent or oil from coming in direct contact with it.

#### 2. Provide adequate protection when operating in locations such as the following.

Failure to do so may cause damage or malfunction.

The effect of countermeasures should be checked in individual equipment and machine.

1) Where noise is generated by static electricity, etc.

2) Where there is a strong electric field

3) Where there is a danger of exposure to radiation

4) When in close proximity to power supply lines

#### Operating Environment

### ⚠ Caution

#### 3. Do not use in an environment where oil and chemicals are used.

Operating in environments with coolants, cleaning solvents, various oils or chemicals may cause adverse effects (damage, malfunction) to the unit even in a short period of time.

#### 4. Do not use in an environment where the product could be exposed to corrosive gas or liquid.

This may damage the unit and cause it to malfunction.

#### 5. Do not use in locations with sources of surge generation.

Installation of the unit in an area around the equipment (electromagnetic lifters, high frequency induction furnaces, welding machine, motors, etc.), which generates the large surge voltage could cause to deteriorate an internal circuitry element of the unit or result in damage. Implement countermeasures against the surge from the generating source, and avoid touching the lines with each other.

#### 6. Use the product type that has an integrated surge absorption element when directly driving a load which generates surge voltage by relay, solenoid valves or lamp.

When a surge generating load is directly driven, the unit may be damaged.

#### 7. The product is CE marked, but not immune to lightning strikes. Take measures against lightning strikes in your system.

#### 8. Keep dust, wire scraps and other extraneous material from getting inside the product.

This may cause malfunction or damage.

#### 9. Mount the unit in such locations, where no vibration or shock is affected.

This may cause malfunction or damage.

#### 10. Do not use in places where there are cyclic temperature changes.

In case that the cyclic temperature is beyond normal temperature changes, the internal unit is likely to be adversely effected.

#### 11. Do not use in direct sunlight.

Do not use in direct sunlight. It may cause malfunction or damage.

#### 12. Use this product within the specified ambient temperature range.

This may cause malfunction.

#### 13. Do not use in places where there is radiated heat around it.

Such a place is likely to cause malfunction.

#### Adjustment/Operation

### ⚠ Warning

#### 1. Do not perform operation or setting with wet hands.

There is a risk of electrical shock.

## ⚠ Specific Product Precautions 6

Be sure to read this before handling.

EX600

### Adjustment/Operation

#### ⚠ Warning

<Handheld Terminal>

- Do not apply pressure to the LCD.  
There is a possibility of the crack of LCD and injuring.
- The forced input/output function is used to change the signal status forcibly. When operating this function, be sure to check the safety of the surroundings and installation.  
Otherwise, injury or equipment damage could result.
- Incorrect setting of parameters can cause malfunction. Be sure to check the settings before use.  
This may cause injury or equipment damage.

#### ⚠ Caution

- Use a watchmaker's screwdriver with thin blade for the setting of each switch of the SI Unit.  
When setting the switch, do not touch other unrelated parts.  
This may cause parts damage or malfunction due to a short circuit.
- Provide adequate setting for the operating conditions.  
Failure to do so could result in malfunction.  
Refer to the operation manual for setting of the switches.
- For the details of programming and address setting, refer to the manual from the PLC manufacturer.  
The content of programming related to protocol is designed by the manufacturer of the PLC used.

<Handheld Terminal>

- Do not press the setting buttons with a sharp pointed object.  
This may cause damage or malfunction.
- Do not apply excessive load and impact to the setting buttons.  
This may cause damage, equipment failure or malfunction.

When the order does not include the SI Unit, the valve plate to connect the manifold and SI Unit is not mounted. Use attached valve holding screws and mount the valve plate.  
(Tightening torque: 0.6 to 0.7 N·m)

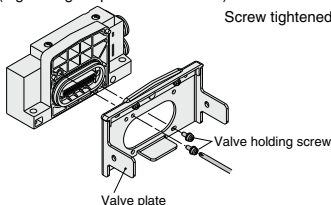

### Maintenance

#### ⚠ Warning

- Do not disassemble, modify (including circuit board replacement) or repair this product.  
Such actions are likely to cause injuries or breakage.
- When an inspection is performed,
  - Turn off the power supply.
  - Stop the air supply, exhaust the residual pressure in piping and verify that the air is released before performing maintenance work.  
Unexpected malfunction of system components and injury can result.

#### ⚠ Caution

- When handling and replacing the unit:
  - Do not touch the sharp metal parts of the connector or plug.
  - Do not apply excessive force to the unit when disassembling.  
The connecting portions of the unit are firmly joined with seals.
  - When joining units, take care not to get fingers caught between units.  
Injury can result.
- Perform periodic inspection.  
Unexpected malfunction in the system composition devices is likely to occur due to malfunction of machinery or equipment.
- After maintenance, make sure to perform an appropriate functionality inspection.  
In cases of abnormality such as faulty operation, stop operation. Unexpected malfunction in the system composition devices is likely to occur.
- Do not use benzene and thinner for cleaning units.  
Damage to the surface or erasure of the display can result. Wipe off any stains with a soft cloth.  
If the stain is persistent, wipe off with a cloth soaked in a dilute solution of neutral detergent and wrung out tightly, and then finish with a dry cloth.

### Other

#### ⚠ Caution

- Refer to the catalog of each series for Common Precautions and Specific Product Precautions on manifold solenoid valves.

#### ■ Trademark

DeviceNet® is a registered trademark of ODVA, Inc. EtherNet/IP® is a registered trademark of ODVA, Inc. CompoNet® is a registered trademark of ODVA, Inc. EtherCAT® is registered trademark and patented technology, licensed by Beckhoff Automation GmbH, Germany.