

Vacuum Filter

New

RoHS

Prevents vacuum equipment trouble

Nominal filtration rating **5, 40, 80 μm**

Large flow capacity **max. 660 L/min (ANR)**

* Large flow type ($\Delta P =$ at 4 kPa)

2 types are available for different applications.

Large flow type **Dust removal**



Air coming from the IN side is filtered by the element after passing through the deflector.

Water drop removal type **Water drop removal + Dust removal**



Air coming from the IN side is rotated when passing through the fans in the deflector. Moisture is separated by centrifugal force.

Elements can be reused by washing them.

* For 40 μm and 80 μm

Water drops can be removed.*1

*1 Water drop removal ratio: 80%.

At recommended flow rate (representative values).

*1 For water drop removal type



Model	Port size				Flow rate [L/min (ANR)]						
	1/8	1/4	3/8	1/2	100	200	300	400	500	600	700
AFJ20-D	●	●			Max. 180						
AFJ30-D		●	●		Max. 380						
AFJ40-D		●	●	●	Max. 660						

* Large flow type ($\Delta P =$ at 4 kPa)

AFJ-D Series



CAT.ES100-165A

Selectable filtration rating



5 µm
White
(Non-woven fabric)

40 µm
Washable
Black

80 µm
Washable
White

Better visibility & environmental resistance



The bowl is covered with a transparent bowl guard!

* Body sizes 30 and larger

- The inside is visible from 360°.
- The inner bowl is protected from the environment, allowing for improved safety

Inner bowl
Material: Polycarbonate

Transparent bowl guard
Material: Polycarbonate

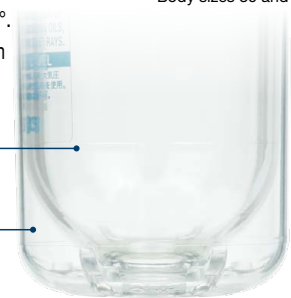

Easy to handle

The element and the bowl are in one piece. Replacement can be done in hand.



Metal related corrosion does not occur.

Resin body does not rust.



Application Examples

- Collect particles before the ejector to lengthen the ejector life.
- To prevent cleaning water left on the workpiece from entering into the ejector when the pad picks up the workpiece.

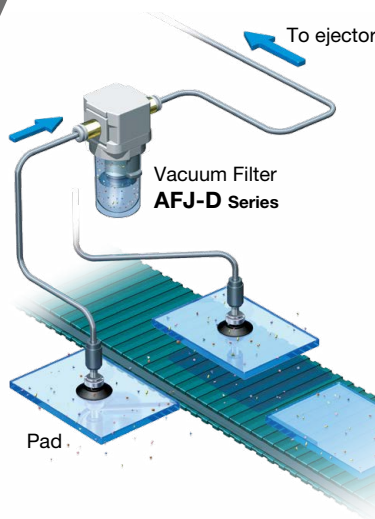

Application to ejector system

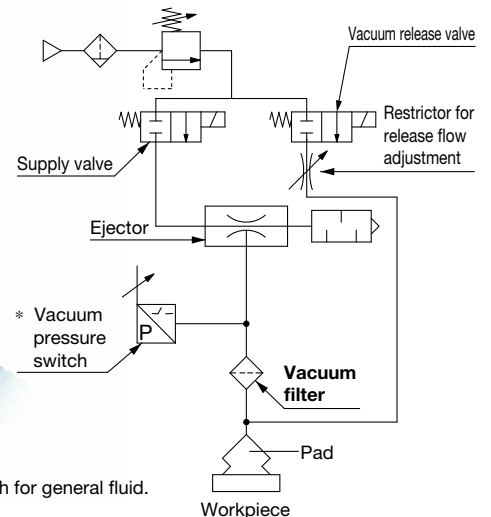

* If water droplets enter to the vacuum pressure switch, use a vacuum pressure switch for general fluid. For handling, refer to Common Precautions and the Operation Manual.

Vacuum Filter

AFJ20-D to AFJ40-D

Symbol
Vacuum filter

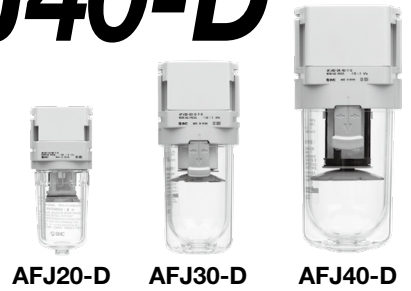
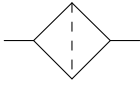

How to Order

AFJ **30** - **03** **B** - **80** - **T** - **D**

① ② ③ ④ ⑤ ⑥ ⑦

Option and Semi-standard Symbol Selection

- Select one each for a to c.
 - When more than one specification is required, indicate in alphanumeric order.
- Example) AFJ30-F03B-80-T-6R-D

	Symbol	Description	① Body size			
			20	30	40	
② Pipe thread type	Nil	Rc	●	●	●	
	N	NPT	●	●	●	
	F	G	●	●	●	
+						
③ Port size	01	1/8	●	—	—	
	02	1/4	●	●	●	
	03	3/8	—	●	●	
	04	1/2	—	—	●	
+						
④ Bracket	Nil	None	●	●	●	
	B*1	With bracket	●	●	●	
+						
⑤ Nominal filtration degree	5	5 μm	●	●	●	
	40	40 μm	●	●	●	
	80	80 μm	●	●	●	
+						
⑥ Type	S	Water drop removal type	●	●	●	
	T	Large flow type	●	●	●	
+						
⑦ Semi-standard	a Bowl*2	Nil	Polycarbonate bowl	●	●	●
		6	Nylon bowl	●	●	●
	+					
	b Flow direction	Nil	Flow direction: Left to right	●	●	●
		R	Flow direction: Right to left	●	●	●
	+					
c Pressure unit	Nil	Unit on product label: kPa, °C	●	●	●	
	Z*3	Unit on product label: psi, °F	○*4	○*4	○*4	

*1 Option B is not assembled and supplied loose at the time of shipment. The assembly consists of 2 types of the bracket and 2 mounting screws.

*2 Refer to Chemical data on page 6 for chemical resistance of the bowl.

*3 For pipe thread type NPT. This product is for overseas use only according to the new Measurement Law. (The SI unit type is provided for use in Japan.)

*4 ○: For pipe thread type NPT only

AFJ20-D to AFJ40-D Series

Standard Specifications

Model			AFJ20-D		AFJ30-D		AFJ40-D		
Port size			1/8	1/4	1/4	3/8	1/4	3/8	1/2
Fluid			Air						
Ambient and fluid temperature			-5 to 60°C (No freezing)						
Proof pressure			0.5 MPa						
Operating pressure range			-100 to 0 kPa						
Vacuum release pressure			0.5 MPa or less						
Nominal filtration rating *1 to *4			5 μm, 40 μm, 80 μm						
Drain capacity			8 cm ³		25 cm ³		45 cm ³		
Bowl material			Polycarbonate						
Bowl guard			—		Standard (Polycarbonate)				
Recommended flow rate *5 [L/min (ANR)]	Water drop removal type (-S)	5 μm	80	100	180	230	200	310	370
		40 μm	100	130	210	340	230	390	500
		80 μm							
	Large flow type (-T)	5 μm	100	140	190	250	210	350	440
		40 μm	120	180	230	380	250	480	660
		80 μm							
Weight [kg]			0.09 kg		0.17 kg		0.35 kg		

*1 5 μm elements use fiber type element which filtrate 5 μm.

*2 The element for 40 μm uses a resin mesh with openings of 40 μm in height and width.

*3 The element for 80 μm uses a resin mesh with openings of 80 μm in height and width.

*4 The size of solid particles collectable by the element 40 μm (80 μm) shall be 40 μm (80 μm) or more in depth x height x width.

*5 The amount of processed air when the initial pressure loss is 4 kPa.

Vacuum Filter **AFJ20-D to AFJ40-D Series**

Flow Rate Characteristics (Representative values)

Water Drop Removal Type

5 μm

AFJ20-02-5-S-D/AFJ30-03-5-S-D/AFJ40-04-5-S-D

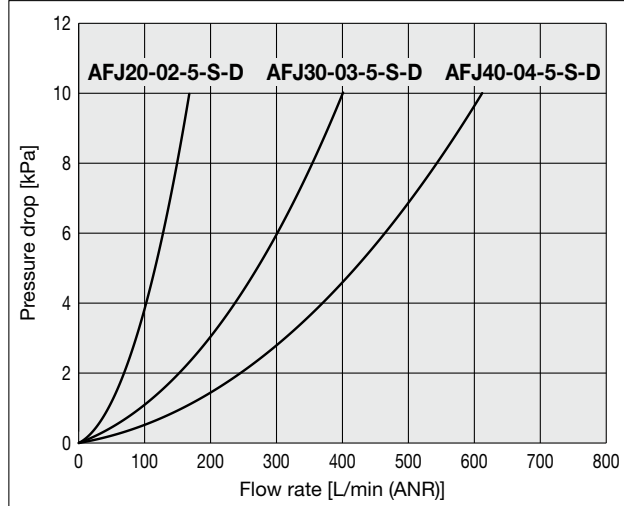

40 μm

AFJ20-02-40-S-D/AFJ30-03-40-S-D/AFJ40-04-40-S-D

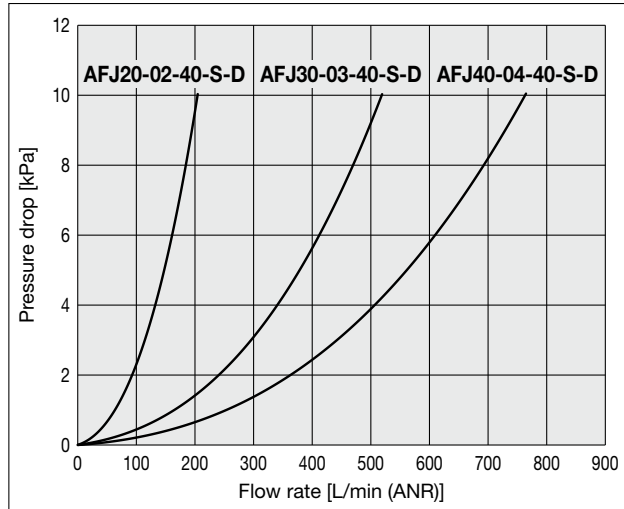

80 μm

AFJ20-02-80-S-D/AFJ30-03-80-S-D/AFJ40-04-80-S-D

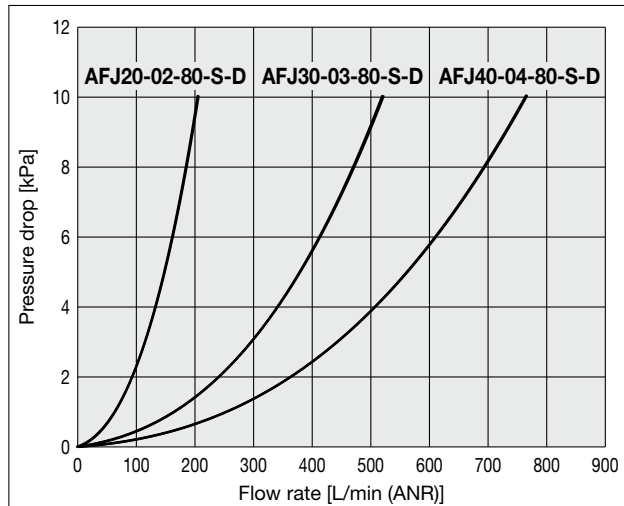

Large Flow Type

5 μm

AFJ20-02-5-T-D/AFJ30-03-5-T-D/AFJ40-04-5-T-D

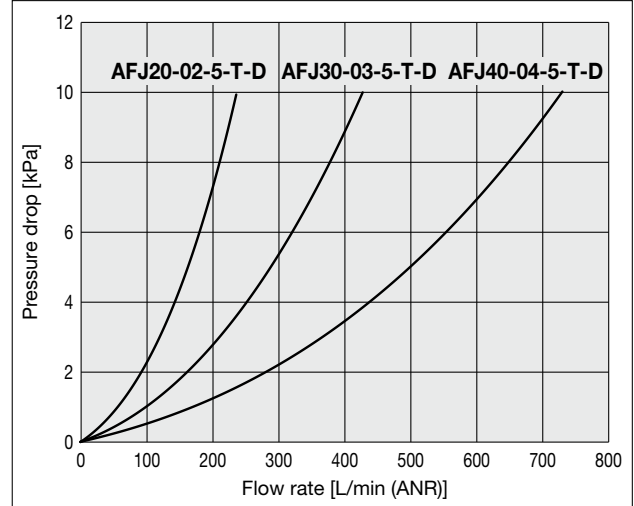

40 μm

AFJ20-02-40-T-D/AFJ30-03-40-T-D/AFJ40-04-40-T-D

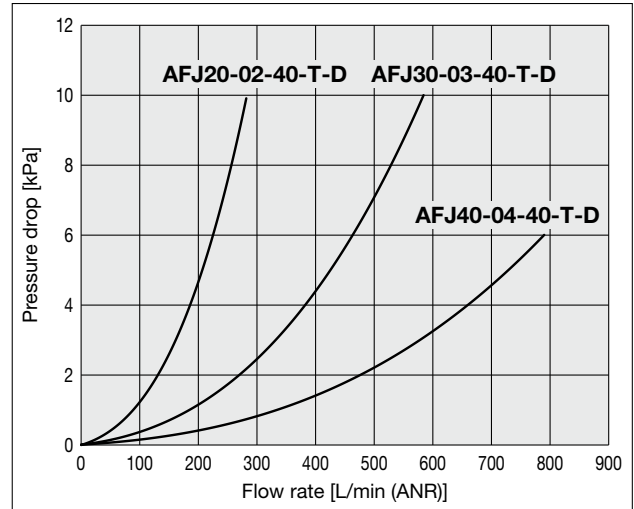

80 μm

AFJ20-02-80-T-D/AFJ30-03-80-T-D/AFJ40-04-80-T-D

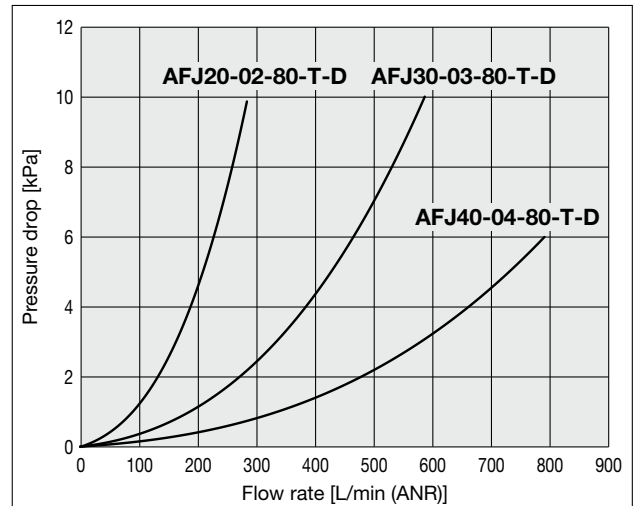

AFJ20-D to AFJ40-D Series

Dimensions

AFJ20-D

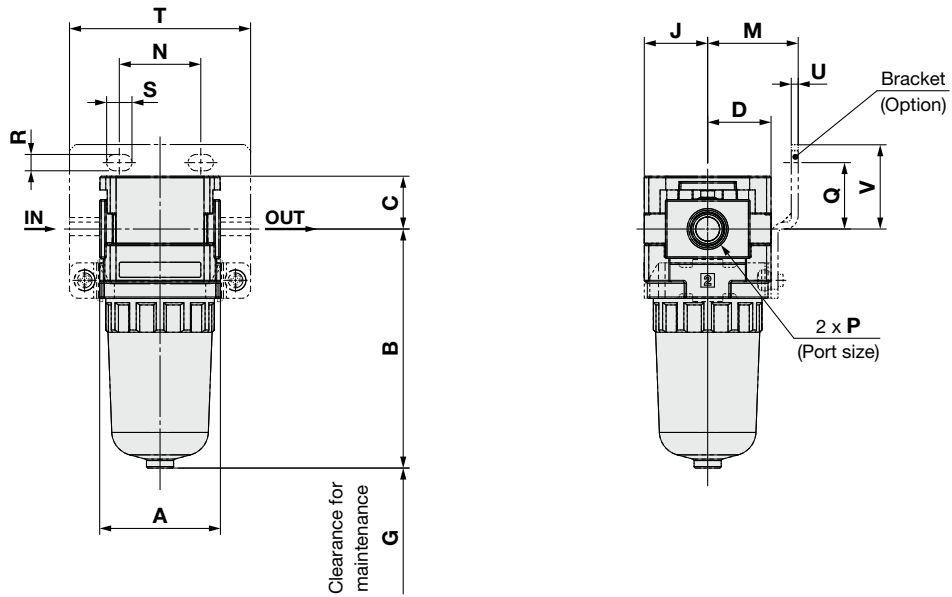

AFJ30-D, AFJ40-D

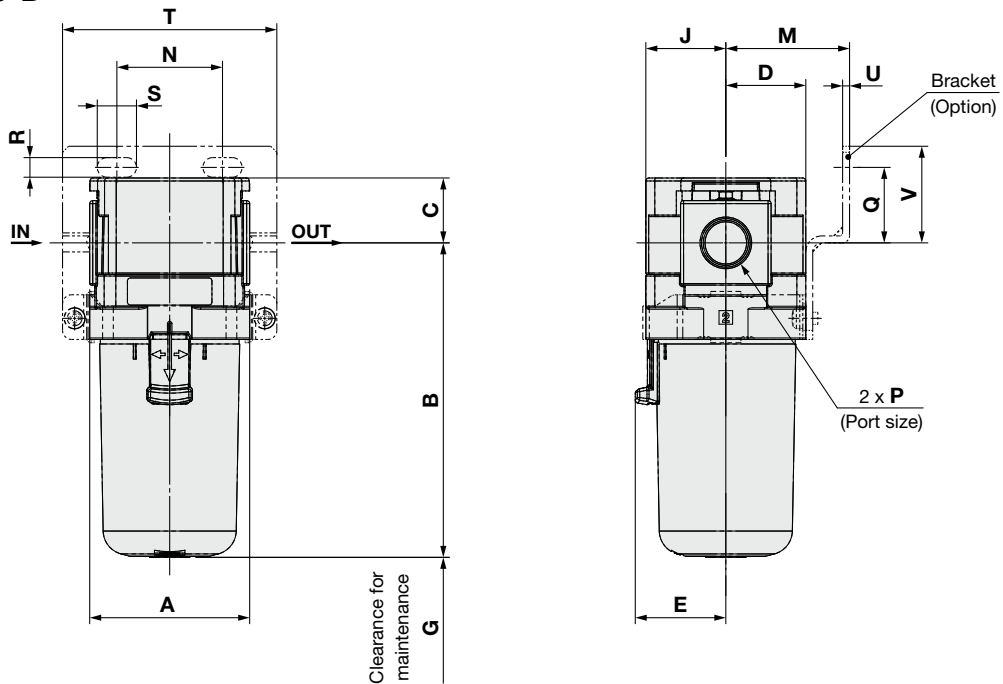

Model	Standard specifications								Optional specifications							
	P	A	B	C	D	E	G	J	M	N	Q	R	S	T	U	V
AFJ20-D	1/8, 1/4	40	79.3	17.5	21	—	25	21	30	27	22	5.4	8.4	60	2.3	28
AFJ30-D	1/4, 3/8	53	104.3	21.5	26.5	30	35	26.5	41	35	25	6.5	13	71	2.3	32
AFJ40-D	1/4, 3/8, 1/2	70	136.1	25.5	35.5	38.4	40	35.5	50	52	30	8.5	12.5	88	2.3	39

AFJ20-D to AFJ40-D Series Accessories (Optional Parts)

Bracket Assembly

AF 24 P - 070AS

● Body size

24	Size 20
34	Size 30
44	Size 40

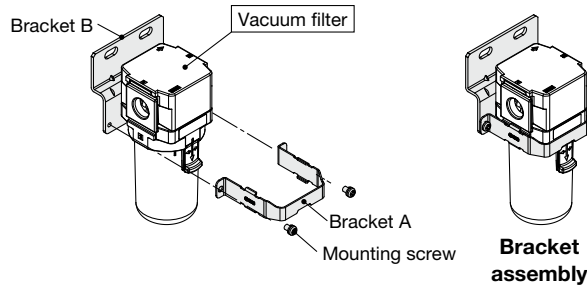

* The assembly consists of a bracket A/B and 2 mounting screws.

Element

5 μm

AF 20 P - 060S

● Body size

20	Size 20
30	Size 30
40	Size 40



40 μm

AF 22 P - 820S

● Body size

22	Size 20
32	Size 30
42	Size 40



80 μm

AF 22 P - 830S

● Body size

22	Size 20
32	Size 30
42	Size 40



⚠ Precautions

Be sure to read this before handling the products. Refer to the back cover for safety instructions. For F.R.L. units precautions, refer to the "Handling Precautions for SMC Products" and the "Operation Manual" on the SMC website: <https://www.smcworld.com>

Design / Selection

⚠ Warning

- The standard bowl for the vacuum filter is made of polycarbonate. Do not use in an environment where they are exposed to or come in contact with organic solvents, chemicals, cutting oil, synthetic oil, alkali, and thread lock solutions.

Chemical resistance of polycarbonate or nylon bowl

Type	Chemical name	Application examples	Material	
			Polycarbonate	Nylon
Acid	Hydrochloric acid Sulfuric acid, Phosphoric acid Chromic acid	Acid washing liquid for metals	△	×
Alkaline	Sodium hydroxide (Caustic soda) Potash Calcium hydroxide (Slack lime) Ammonia water Carbonate of soda	Degreasing of metals Industrial salts Water-soluble cutting oil	×	○
Inorganic salts	Sodium sulfide Sulfate of potash Sulfate of soda	—	×	△
Chlorine solvents	Carbon tetrachloride Chloroform Ethylene chloride Methylene chloride	Cleansing liquid for metals Printing ink Dilution	×	△
Aromatic series	Benzene Toluene Paint thinner	Coatings Dry cleaning	×	△

○: Essentially safe △: Some effects may occur. ×: Effects will occur.

Type	Chemical name	Application examples	Material	
			Polycarbonate	Nylon
Ketone	Acetone Methyl ethyl ketone Cyclohexane	Photographic film Dry cleaning Textile industries	×	×
Alcohol	Ethyl alcohol IPA Methyl alcohol	Antifreeze Adhesives	△	×
Oil	Gasoline Kerosene	—	×	○
Ester	Phthalic acid dimethyl Phthalic acid diethyl Acetic acid	Synthetic oil Anti-rust additives	×	○
Ether	Methyl ether Ethyl ether	Brake oil additives	×	○
Amino	Methyl amino	Cutting oil Brake oil additives Rubber accelerator	×	×
Others	Thread-lock fluid Sea water Leak tester	—	×	△

○: Essentially safe △: Some effects may occur. ×: Effects will occur.

- Oil included in air cannot be separated.

Safety Instructions

These safety instructions are intended to prevent hazardous situations and/or equipment damage. These instructions indicate the level of potential hazard with the labels of “**Caution**,” “**Warning**” or “**Danger**.” They are all important notes for safety and must be followed in addition to International Standards (ISO/IEC)*1), and other safety regulations.

 **Danger :** **Danger** indicates a hazard with a high level of risk which, if not avoided, will result in death or serious injury.

 **Warning:** **Warning** indicates a hazard with a medium level of risk which, if not avoided, could result in death or serious injury.

 **Caution:** **Caution** indicates a hazard with a low level of risk which, if not avoided, could result in minor or moderate injury.

*1) ISO 4414: Pneumatic fluid power - General rules and safety requirements for systems and their components
ISO 4413: Hydraulic fluid power - General rules and safety requirements for systems and their components
IEC 60204-1: Safety of machinery - Electrical equipment of machines - Part 1: General requirements
ISO 10218-1: Robots and robotic devices - Safety requirements for industrial robots - Part 1: Robots etc.

Warning

1. The compatibility of the product is the responsibility of the person who designs the equipment or decides its specifications.

Since the product specified here is used under various operating conditions, its compatibility with specific equipment must be decided by the person who designs the equipment or decides its specifications based on necessary analysis and test results. The expected performance and safety assurance of the equipment will be the responsibility of the person who has determined its compatibility with the product. This person should also continuously review all specifications of the product referring to its latest catalog information, with a view to giving due consideration to any possibility of equipment failure when configuring the equipment.

2. Only personnel with appropriate training should operate machinery and equipment.

The product specified here may become unsafe if handled incorrectly. The assembly, operation and maintenance of machines or equipment including our products must be performed by an operator who is appropriately trained and experienced.

3. Do not service or attempt to remove product and machinery/equipment until safety is confirmed.

1. The inspection and maintenance of machinery/equipment should only be performed after measures to prevent falling or runaway of the driven objects have been confirmed.
2. When the product is to be removed, confirm that the safety measures as mentioned above are implemented and the power from any appropriate source is cut, and read and understand the specific product precautions of all relevant products carefully.
3. Before machinery/equipment is restarted, take measures to prevent unexpected operation and malfunction.

4. Our products cannot be used beyond their specifications. Our products are not developed, designed, and manufactured to be used under the following conditions or environments. Use under such conditions or environments is not covered.

1. Conditions and environments outside of the given specifications, or use outdoors or in a place exposed to direct sunlight.
2. Use for nuclear power, railways, aviation, space equipment, ships, vehicles, military application, equipment affecting human life, body, and property, fuel equipment, entertainment equipment, emergency shut-off circuits, press clutches, brake circuits, safety equipment, etc., and use for applications that do not conform to standard specifications such as catalogs and operation manuals.
3. Use for interlock circuits, except for use with double interlock such as installing a mechanical protection function in case of failure. Please periodically inspect the product to confirm that the product is operating properly.

Caution

We develop, design, and manufacture our products to be used for automatic control equipment, and provide them for peaceful use in manufacturing industries.

Use in non-manufacturing industries is not covered.

Products we manufacture and sell cannot be used for the purpose of transactions or certification specified in the Measurement Act.

The new Measurement Act prohibits use of any unit other than SI units in Japan.

Limited warranty and Disclaimer/ Compliance Requirements

The product used is subject to the following “Limited warranty and Disclaimer” and “Compliance Requirements”.

Read and accept them before using the product.

Limited warranty and Disclaimer

1. The warranty period of the product is 1 year in service or 1.5 years after the product is delivered, whichever is first.*2)
Also, the product may have specified durability, running distance or replacement parts. Please consult your nearest sales branch.
2. For any failure or damage reported within the warranty period which is clearly our responsibility, a replacement product or necessary parts will be provided. This limited warranty applies only to our product independently, and not to any other damage incurred due to the failure of the product.
3. Prior to using SMC products, please read and understand the warranty terms and disclaimers noted in the specified catalog for the particular products.

*2) **Vacuum pads are excluded from this 1 year warranty.**

A vacuum pad is a consumable part, so it is warranted for a year after it is delivered.

Also, even within the warranty period, the wear of a product due to the use of the vacuum pad or failure due to the deterioration of rubber material are not covered by the limited warranty.

Compliance Requirements

1. The use of SMC products with production equipment for the manufacture of weapons of mass destruction (WMD) or any other weapon is strictly prohibited.
2. The exports of SMC products or technology from one country to another are governed by the relevant security laws and regulations of the countries involved in the transaction. Prior to the shipment of a SMC product to another country, assure that all local rules governing that export are known and followed.

Safety Instructions

Be sure to read the “Handling Precautions for SMC Products” (M-E03-3) and “Operation Manual” before use.

SMC Corporation

Akihabara UDX 15F,
4-14-1, Sotokanda, Chiyoda-ku, Tokyo 101-0021, JAPAN
Phone: 03-5207-8249 Fax: 03-5298-5362
<https://www.smcworld.com>
© 2024 SMC Corporation All Rights Reserved

Specifications are subject to change without prior notice and any obligation on the part of the manufacturer.

D-G