

Pads for Special Applications **ZP2/ZP3/ZP3P Series**

ø0.8 to ø125

Mark-free, Static Neutralization, For Film Adsorption, Multistage, Flat, Nozzle, Sponge, For Disk Adsorption, For Panel Holding, Ball Spline Buffer

Mark-free ø4 to ø125

For use where adsorption marks must not be left on workpieces **p. 251**

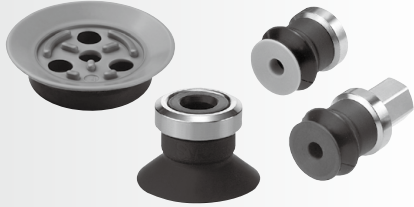

Static Neutralization ø4 to ø16

Discharge static electricity gently. Prevent damage to electronic parts. **Web Catalog**



For Film Adsorption ø20 to ø50

Good for film packaging applications **ZP3P-PT p. 266**
ZP3P-JT Web Catalog



Multistage ø6 to ø46

For spherical workpieces or workpieces with inclined surfaces **p. 276**



Flat ø10 to ø30

For flexible sheets or vinyl **p. 286**



Nozzle ø0.8/ø1.1

Compact, Space saving **p. 289**



Sponge ø4 to ø15

For workpieces with bumps **p. 290**



For Disk Adsorption

• For the adsorption of circular components like CDs and DVDs **p. 294**
• The bellows mechanism in the pad helps to dampen the impact to workpieces.



For Panel Holding

• For the adsorption and holding of the stage of panels, glass circuit boards, etc. **p. 295**
• The bellows mechanism allows for complete contact with curved work surfaces.

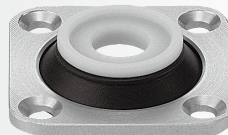

Ball Spline Buffer ø2 to ø8

The ball spline guide is used for buffers. **p. 297**



Pad Material: ZP2 Series

Material	NBR (Nitrile rubber)	Silicone rubber *1*2	Urethane rubber	FKM (Fluoro rubber)	Conductive NBR (Nitrile rubber)	Conductive silicone rubber	Mark-free NBR pad
Color of rubber	Black	White	Brown	Black			
Rubber hardness (Shore A: ±5°)	50	40 to 60	55 to 60	60 to 70	60 to 70	50 to 60	60

Material	Conductive EPDM sponge
Color of rubber	Black
Hardness [Asker-C]	25

*1 Compliant with the FDA (USA Food and Drug Administration) regulation 21CFR§177.2600 for "Rubber articles intended for repeated use"













*2 Compliant with the standards for "Rubber apparatus (excluding baby drinking apparatus) and containers/packaging" (D3) (Partial revision: Ministry of Health, Labour, and Welfare Notification No. 595, 2012) in Section 3 "Apparatus and Containers/Packaging" of the Japan Food Sanitation Act, Article 18 "Specifications and Standards for Food and Food Additives, etc." (Ministry of Health and Welfare Notification No. 370, 1959).

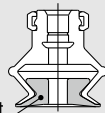

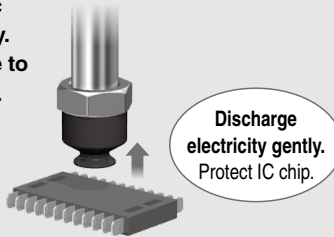

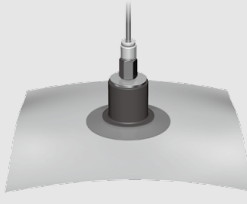

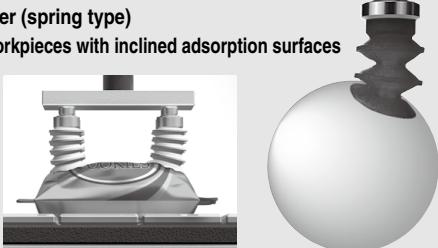
Pad Material: ZP3P Series

Material	Silicone rubber*1
Color of rubber	Blue
Rubber hardness (Shore A: ±5°)	40

*1 Compliant with the FDA (USA Food and Drug Administration) regulation 21CFR§177.2600 for "Rubber articles intended for repeated use"

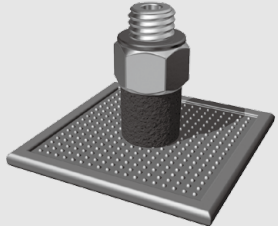
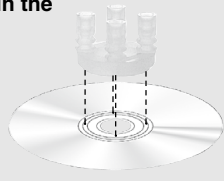
Model Selection
 For Special Applications
 Mark-free
 For Film Adsorption
 Multistage
 Flat
 Nozzle
 Sponge
 For Disk Adsorption
 For Panel Holding
 Ball Spline Buffer
 Construction
 Mounting Bracket Assembly
 Precautions

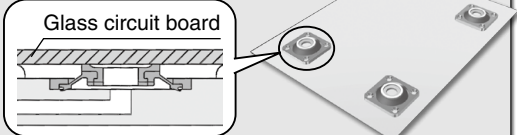
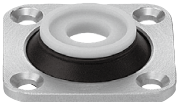
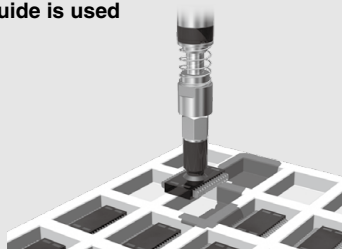
	Application	Symbol	Pad		Page	
			Form	Diameter		
Mark-free	<p>Mark-free Pad For use where adsorption marks must not be left on workpieces</p> <div style="display: flex; justify-content: space-around;"> <div style="text-align: center;"> <p>Standard pad</p>  <p>Clear trace of the pad</p> </div> <div style="text-align: center;"> <p>Mark-free pad</p>  <p>No trace of the pad</p> </div> </div> <p> <input type="checkbox"/> Mark-free NBR pad <input type="checkbox"/> Fluororesin-coated pad </p> 	 Single unit	U	Flat type	ø4, ø6, ø8 ø10, ø16 ø25, ø32 ø40, ø50	253
		 Single unit	H	High rigidity (Flat type with ribs)	ø40, ø50 ø63, ø80 ø100, ø125	254
	<p>Resin Attachment Mark-free, Prevents the rubber from sticking to workpieces</p>  <p>Attachment</p>	 Single unit With pad	—	Bellows type	ø6, ø8 ø10, ø13 ø16, ø20 ø25, ø32	264
Static Neutralization	<p>Static Neutralization Pad Discharge static electricity gently. Prevent damage to electronic parts.</p>  <p style="border: 1px solid black; border-radius: 50%; padding: 5px; display: inline-block;">Discharge electricity gently. Protect IC chip.</p>	 Single unit With pad	T	Flat type with groove	ø4, ø6, ø8 ø10, ø13 ø16	Web Catalog
For Film Adsorption	<p>For Film Adsorption Good for film packaging applications</p> 	 Single unit	PT		ø20, ø25 ø35, ø50	267
		 Single unit	JT		ø20, ø25 ø32, ø40 ø50	Web Catalog
Multistage	<p>Bellows Pad For use where there is no space for a buffer (spring type) For workpieces with inclined adsorption surfaces</p> 	 Single unit With adapter	ZJ	Bellows type (Multistage type)	ø15, ø20 ø30, ø40 ø46	276
		 Single unit With adapter	J	Bellows type (Multistage type)	ø6, ø9, ø10 ø14, ø15 ø16, ø25 ø30	282

	Application	Symbol	Pad		Page
			Form	Diameter	
Flat	Flat Pad For the adsorption of flexible sheets or film Reduced deformation of flat surfaces during adsorption	 Single unit With adapter	MT Thin flat type (With groove)	$\varnothing 10, \varnothing 15$ $\varnothing 20, \varnothing 25$ $\varnothing 30$	286
Nozzle	Nozzle Pad For the adsorption of small components such as IC chips	 Single unit With adapter	AN Nozzle type	$\varnothing 0.8, \varnothing 1.1$	289
Sponge	Sponge Pad For the adsorption of workpieces with bumps	 Single unit With adapter	S Sponge	$\varnothing 4, \varnothing 6, \varnothing 8$ $\varnothing 10, \varnothing 15$	290
					291
For Disk Adsorption	Vacuum Pad for Disk Adsorption <ul style="list-style-type: none"> For the adsorption of circular components like CDs and DVDs The bellows mechanism in the pad helps to dampen the impact to workpieces. 	 	20 x 25 (ID x OD: PCD 22.5)		294
For Panel Holding	Vacuum Pad for Panel Holding <ul style="list-style-type: none"> For the adsorption and holding of the stage of panels, glass circuit boards, etc. The bellows mechanism allows for complete contact with curved work surfaces. 	 	—		295
Ball Spline Buffer	Pad with Ball Spline Buffer The ball spline guide is used for buffers.	 	U Flat type	$\varnothing 2, \varnothing 4$ $\varnothing 6, \varnothing 8$	297

Model Selection
For Special Applications
Mark-free
For Film Adsorption
Multistage
Flat
Nozzle
Sponge
For Disk Adsorption
For Panel Holding
Ball Spline Buffer
Construction
Mounting Bracket Assembly
Precautions

Mark-free Pad Series ZP2/ZP3E Series

Minimizes the transfer of rubber constituents to workpieces

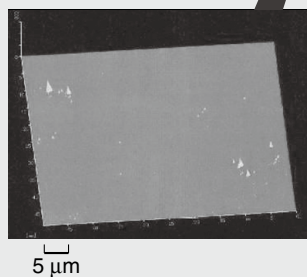
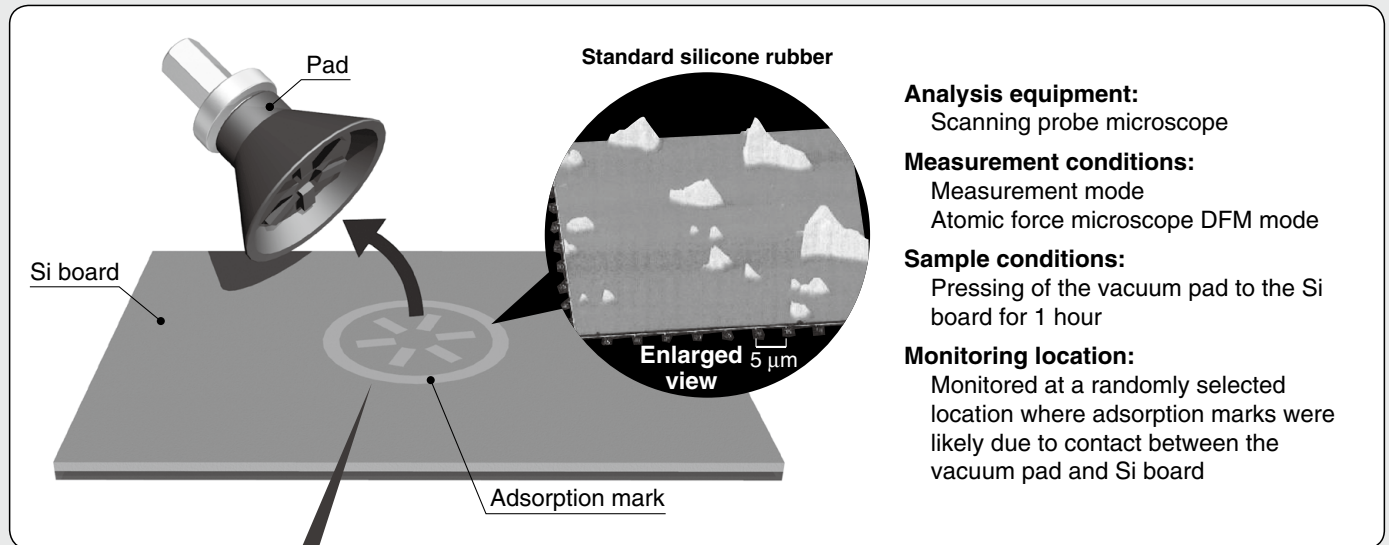

1 Mark-free NBR Pad

Minimizes the transfer of rubber constituents which are said to be the cause of adsorption marks

Pad diameter: ϕ 4 to ϕ 125

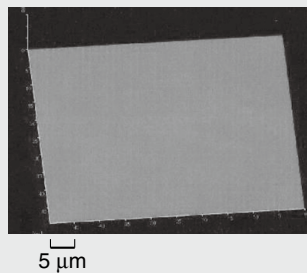
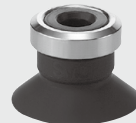

2 Fluoro-resin-coated Pad

A fluoro-resin sheet is baked onto the pad adsorption surface. Prevents the transfer of rubber constituents

Pad diameter: ϕ 40 to ϕ 125

Pad material: NBR, FKM

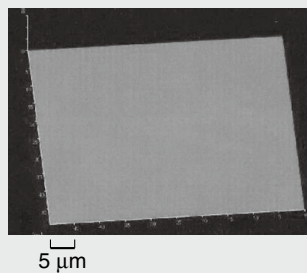

3 Resin Attachment



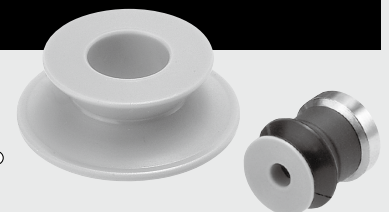
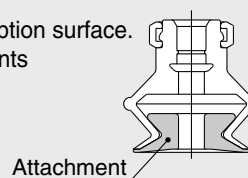

PEEK material is used for the pad adsorption surface. Prevents the transfer of rubber constituents

Applicable pad diameter: ϕ 6 to ϕ 32



The above images of adsorption marks are sample data. Actual results will depend on the actual conditions.

Mark-free Pad Series ZP2/ZP3E Series

	Pad type	Series	Pad form	Material of the adsorption part (Part in contact with workpieces)	Adsorption mark* ¹		Operating temperature range (°C)	Static friction ratio* ⁵
					Condition* ² (Initial value)			
					Visual checking	Vapor method* ³		
Mark-free Pad Series	 Mark-free NBR 	ZP2 ZP3E	Flat type Flat type with groove Bellows type with ribs and groove	Mark-free NBR (Specially treated* ⁴)	●	●	5 to 40	0.15 to 0.2
	 Fluororesin-coated 	ZP2	Flat type with ribs	NBR + Fluororesin coating	●	●	5 to 60	0.1
				FKM + Fluororesin coating	●	●	5 to 100	
Resin attachment		ZP2	Applicable for the bellows type	PEEK	●	●	5 to 40	0.15 to 0.2
				Conductive PEEK (Volume resistivity: 1×10 ⁶ Ωcm)	●	●		
Standard	ZP Series (Standard material)			NBR FKM Conductive NBR/ Silicone rubber	×	×	—	—
				Silicone rubber Urethane rubber	○	×		

Adsorption mark characteristics [●: Little or no influence ○: Can be used depending on the conditions ×: Not suitable]

- *¹ **Adsorption mark** ——— Indicates the transfer of rubber constituents from the pad
- *² **Condition** ——— Visual evaluation of the adsorption mark
- *³ **Vapor method** ——— Method of applying vapor to workpieces to visually check for adsorption marks
- *⁴ **Specially treated** ——— The NBR is specially treated to modify and reduce the transfer of rubber constituents.
- *⁵ **Static friction ratio** ——— Static friction ratio when a workpiece (glass) is adsorbed by the pad (NBR = 1 as a benchmark)
When a cyclone pad is used, the pad does not come into contact with workpieces (glass).
The customer needs to install a guide for holding.

* The above table is only for reference when selecting a pad.
Values and evaluation are reference data only. Preparatory testing under actual operating conditions is recommended.

Cleaning method [Mark-free NBR pad/Fluororesin-coated pad/Resin attachment]

- Always clean the product before operation and when carrying out regular maintenance.
- 1) Hold a part other than the adsorption surface.
 - * Non particle-generating vinyl gloves are recommended.
- 2) Soak a non particle-generating cloth in 2-propanol (isopropyl alcohol) (purity > 99.5%).
 - * Please use the solution recommended above.
- 3) Wipe the adsorption surface (pad/resin attachment) and the part that comes into contact with workpieces.
- 4) Dry with clean air blow. (Or, wipe again with a dry, non particle-generating cloth.)

Model Selection

For Special Applications

Mark-free

For Film Adsorption

Multistage

Flat

Nozzle

Sponge

For Disk Adsorption

For Panel Holding

Ball Spine Buffer

Construction

Mounting Bracket Assembly

Precautions



Mark-free Pad

Symbol/Form

Pad diameter $\varnothing 4, \varnothing 6, \varnothing 8, \varnothing 10, \varnothing 16, \varnothing 25, \varnothing 32, \varnothing 40, \varnothing 50$

U: Flat type

- Pad which reduces the number of adsorption marks left on workpieces by the rubber
- The pad is made from mark-free NBR, and the NBR is then specially treated to minimize the transfer of rubber constituents to workpieces.

The mounting bracket assembly (adapter, buffer) is the same as that of the ZP series. Refer to the following pages and order it separately.

Mounting Bracket Part Nos.

Adapter Assembly	p. 121 to 123
Buffer Assembly	p. 124 to 126
Lock Ring Unit	p. 31

How to Order

Pad unit **ZP2-04 U CL-X19**



Pad diameter

Symbol	Pad diameter
04	$\varnothing 4$
06	$\varnothing 6$
08	$\varnothing 8$
10	$\varnothing 10$
16	$\varnothing 16$
25	$\varnothing 25$
32	$\varnothing 32$
40	$\varnothing 40$
50	$\varnothing 50$

With/Without lock ring

Nil	With lock ring
X19	Without lock ring *1

*1 $\varnothing 10$ or larger

Pad material

Symbol	Material
CL	Mark-free NBR

Pad form

Symbol	Form
U	Flat type

* The lock ring is shipped together but does not come assembled.

Dimensions: Pad Unit

* The dimensions of the model with a mounting bracket are the same as those of the ZP series. Refer to the following pages.

With Adapter	p. 33 to 42
With Buffer	p. 43 to 49

ZP2-04 to 08UCL

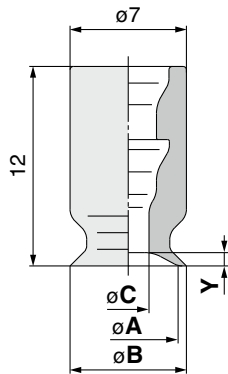

Dimensions

Model	A	B	C	Y
ZP2-04UCL	4	4.8	1.6	0.8
ZP2-06UCL	6	7	2.5	
ZP2-08UCL	8	9		1

ZP2-10 to 50UCL

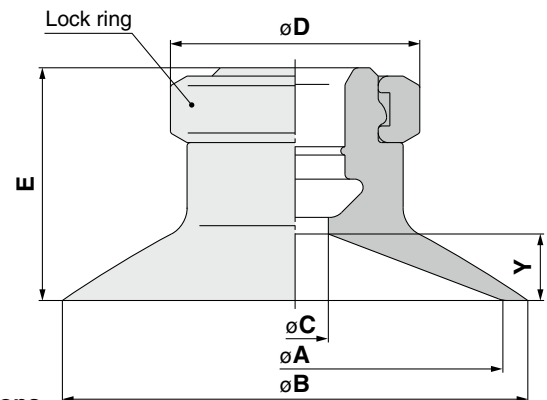

Dimensions

Model	A	B	C	D	E	Y
ZP2-10UCL	10	12	4	13	12	3
ZP2-16UCL	16	18		12.5	3.5	
ZP2-25UCL	25	28	7	15	14	4
ZP2-32UCL	32	35		14.5	4.5	
ZP2-40UCL	40	43	18	18.5	6.5	
ZP2-50UCL	50	53	19.5	7.5		

Adapter Mounting Dimensions

If an adapter will be made by the customer, design the adapter with the dimensions shown below.

Applicable pad 04U/06U/08U

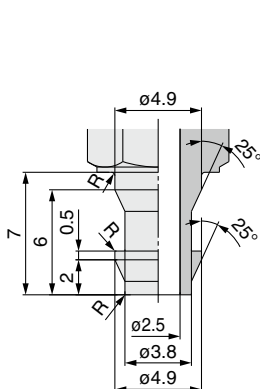

Applicable pad 10U/16U

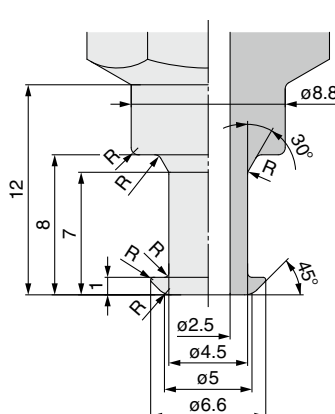

Applicable pad 25U/32U

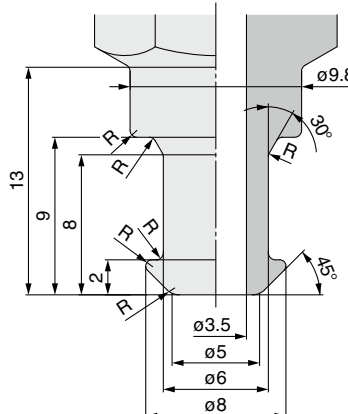

Applicable pad 40U/50U

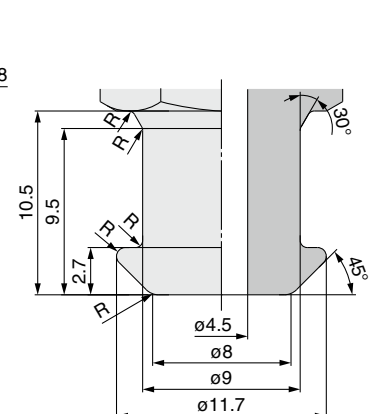

* The R part has to be smooth with no corners.

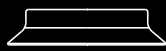

Mark-free Pad/High Rigidity

Symbol/Form

H: Flat type with ribs

Pad diameter $\varnothing 40, \varnothing 50, \varnothing 63, \varnothing 80, \varnothing 100, \varnothing 125$

- Pad which reduces the number of adsorption marks left on workpieces by the rubber
- The pad is made from mark-free NBR, and the NBR is then specially treated to minimize the transfer of rubber constituents to workpieces.
- Prevents the rubber constituents of the pad from transferring to workpieces by baking a fluororesin sheet to the adsorption surface

How to Order

Pad unit **ZP2-40 H CL**

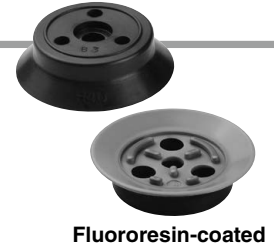

Fluororesin-coated

Pad diameter

Symbol	Pad diameter
40	$\varnothing 40$
50	$\varnothing 50$
63	$\varnothing 63$
80	$\varnothing 80$
100	$\varnothing 100$
125	$\varnothing 125$

Pad material

Symbol	Material
CL	Mark-free NBR
NT	NBR + Fluororesin coating
FT	FKM + Fluororesin coating

Pad form

Symbol	Form
H	High rigidity (Flat type with ribs)

For the mounting bracket assembly, refer to the following pages and order it separately.

Mounting Bracket Part Nos./Dimensions

Adapter Assembly	p. 255, 256
Buffer Assembly	p. 257 to 260
Ball Joint Type	p. 261 to 263

Dimensions: Pad Unit

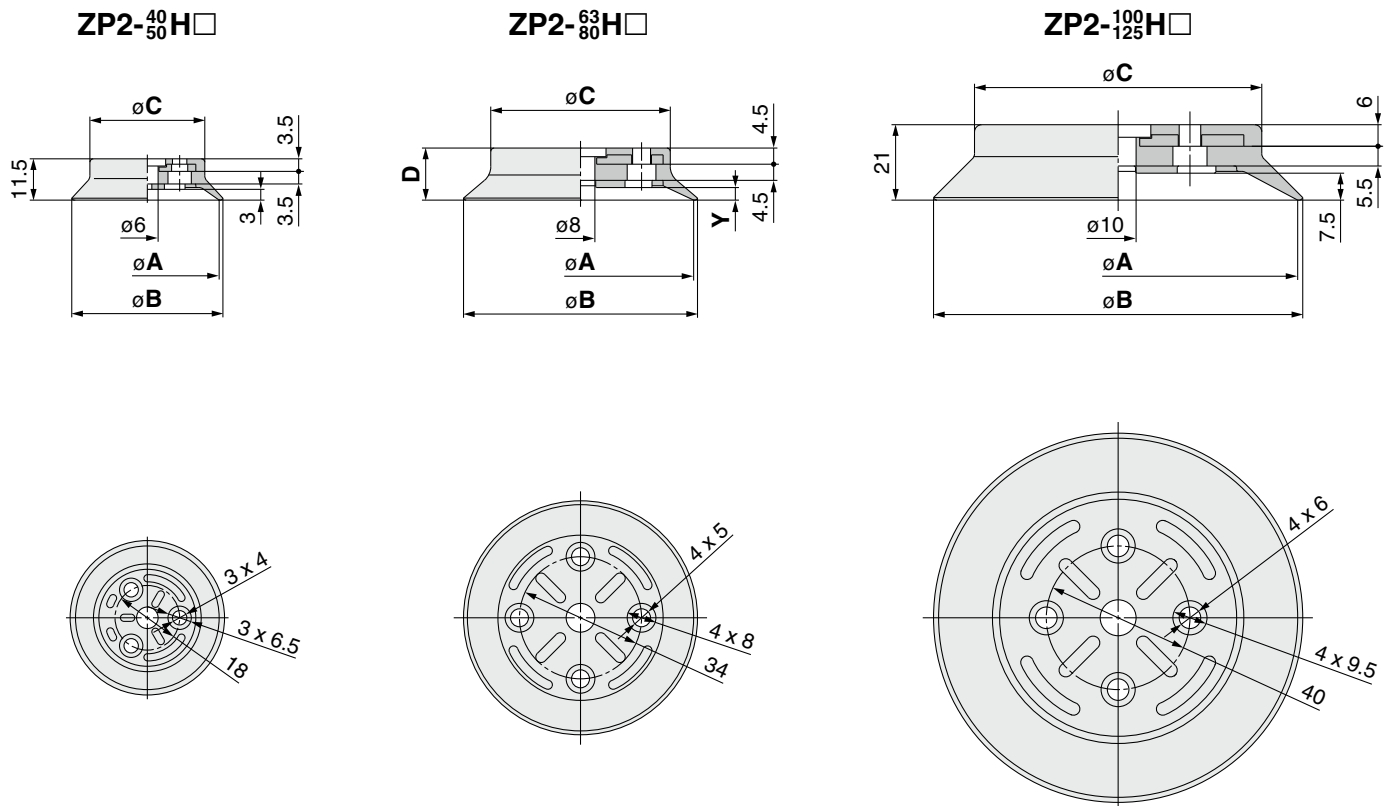

Dimensions

Model	A	B	C
ZP2-40H□	40	42	32
ZP2-50H□	50	53	42

Dimensions

Model	A	B	C	D	Y
ZP2-63H□	63	65	50	14.5	3.5
ZP2-80H□	80	82	61	16.5	4.5

Dimensions

Model	A	B	C
ZP2-100H□	100	103	80
ZP2-125H□	125	128	104

Model Selection

For Special Applications

Mark-free

For Film Adsorption

Multistage

Flat

Nozzle

Sponge

For Disk Adsorption

For Panel Holding

Ball Spine Buffer

Construction

Mounting Bracket Assembly

Precautions

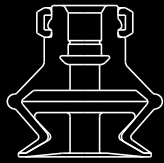

Resin Attachment

Pad diameter $\varnothing 6, \varnothing 8, \varnothing 10, \varnothing 13, \varnothing 16, \varnothing 20, \varnothing 25, \varnothing 32$

No adsorption marks (rubber constituents) are left on workpieces.

Direct contact between workpieces and the rubber can be avoided by mounting a PEEK attachment inside the bellows pad to prevent the transfer of rubber constituents.

Prevents the pad (rubber) from sticking to workpieces

Ideal for the bellows pad ZP series ($\varnothing 6$ to $\varnothing 32$)

The mounting bracket assembly (adapter) is the same as that of the ZP series. Refer to the following pages and order it separately.

Mounting Bracket Part Nos.

Adapter Assembly p. 121 to 123



How to Order

ZP2-06K P

Pad diameter

Symbol	Applicable pad
06	ZP06B□
08	ZP08B□
10	ZP10B□
13	ZP13B□
16	ZP16B□
20	ZP20B□
25	ZP25B□
32	ZP32B□

Attachment material

Symbol	Material
P	PEEK
GP	Conductive PEEK

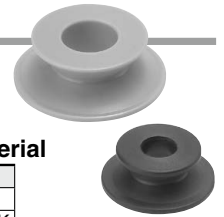

How to Order (When ordering with a pad)

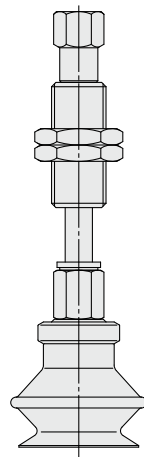
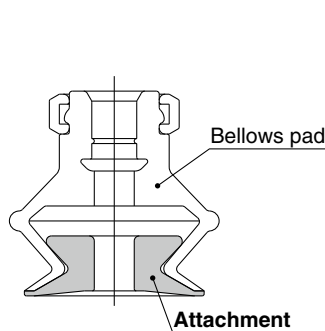

- When ordering with a pad, put "*" below the part number of the pad as shown below. Note that the pad is not delivered with the attachment assembled.
- This attachment can only be mounted inside SMC's standard bellows pads.
- When the attachment is made of conductive PEEK, use conductive material for the pad.

Ordering example ZPT10BNJ10-B5-A10 ← Bellows pad part no. *1
 * ZP2-10KP ← Resin attachment part no.

*1 For part numbers, refer to the basic pad/bellows type (ZP series) on page 67.

Dimensions/Single Unit

* The dimensions of the mounting bracket are the same as the ZP series. Refer to the mounting bracket dimensions on the following pages.

With Adapter p. 69 to 78

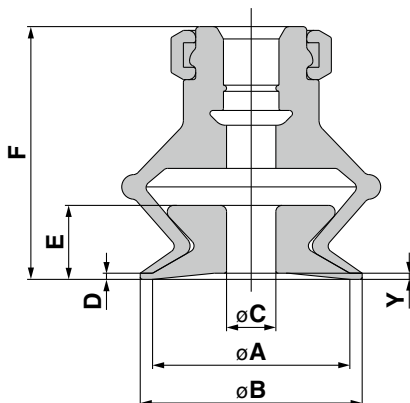

Dimensions

Model	Applicable pad	A	B	C	D	E	F	Y
ZP2-06K■	ZP06B□	6	7	1.6	0.5	3	13.5	0.5
ZP2-08K■	ZP08B□	8	9	3		3.5	16.5	
ZP2-10K■	ZP10B□	10	12	3.5		5.5	19	
ZP2-13K■	ZP13B□	13	15	4	1	6	20.5	1
ZP2-16K■	ZP16B□	16	18			8.5	24.5	
ZP2-20K■	ZP20B□	20	22	8		25	30	
ZP2-25K■	ZP25B□	25	27	10	1	11.5	30	
ZP2-32K■	ZP32B□	32	34					

* ■ in the table indicates the attachment material

* □ in the table indicates the pad material

«Precautions»

- 1) Clean the product before using the attachment.
This product is not cleaned before shipment. If the product is used in the condition in which it was shipped, residual material may be left on workpieces. Clean before use. If you have any questions, please contact SMC.
- 2) The workpiece contact part of this product is made of resin and, therefore, there may be more vacuum pressure leakage during adsorption compared to general rubber pads. Therefore, maintain as large a flow rate as possible to minimize the pressure drop due to leakage.
- 3) Cannot be used for vacuum retention
- 4) Customers are required to conduct an evaluation to judge whether or not the product should be used.

• If contact with hard material is a problem, do not use this product.



Pads for Special Applications/Mark-free Pad

Specific Product Precautions

Be sure to read this before handling the products.

Refer to page 375 for safety instructions. For vacuum equipment and vacuum pad precautions, refer to pages 376 to 379.

Design

1. Although the adsorption marks (transfer of rubber components to workpieces) left by this product have been minimized compared with the existing rubber pads, be sure to confirm whether they affect the actual workpieces in any way before use.
2. Due to the manufacturing method, a large amount of leakage from the seat portion is more likely to occur in the mark-free pad series compared with common rubber pads.
3. Note that this product cannot be used to hold vacuum.
4. Secure as high a flow rate as possible to suppress the pressure drop caused by leakage to a minimum.
5. The fluororesin-coated pad is a molded product which features an integrated fluororesin sheet and rubber (NBR, FKM) composition. Because of this, the height of the product may decrease due to the deterioration of the rubber and the elongation of the fluororesin sheet after repeated usage. This is assuming that the pads are used for the vertical adsorption of workpieces, with even force being applied to the pad skirts. However, when uneven force is applied to the pads or when an operation which causes the pads to change their shape during adsorption is conducted, such as in the following examples, the pad skirts may become deformed (wrinkled).
 - 1) When the pad contacts a workpiece from a diagonal direction
 - 2) When the pad adsorb an irregularly-shaped workpiece or a workpiece with an uneven surface
 - 3) When the pad is used in a stretched condition due to insufficient lifting force

If any of the problems above occur, please reconsider the application.

6. The resin attachment may cause damage to the vacuum pads if vacuum release air exceeding the max. release flow rate listed in the table below is supplied.

Table) Vacuum Release Air Supply Setting

Pad diameter [mm]	Max. release flow rate [L/min (ANR)]
ø6	20
ø8 to ø32	150