

Water Resistant Cylinder (Pneumatic/Hydraulic)

Pneumatic: CM2/CG1/MB/MB1/CQ2/CA2/MGP/MGG/MK/RSQ Series

Hydraulic: CHDKB/CH2F Series

Compatible with an operating environment with coolants.



Anti-coolant performance has been improved compared to the standard cylinders.

Applicable for an operating environment where water splashes.

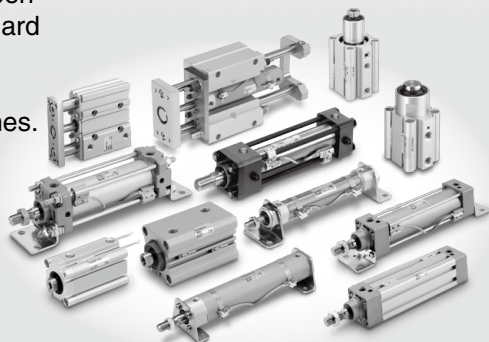

Water Resistant Air Cylinders (Pneumatic/Hydraulic)

Suitable for using under the atmosphere having coolant in the machine tools.

Also, compatible with environments where water is splashed on the food machinery, or car washing machines, etc

Special scraper

- Dramatically improved water resistance compared to standard cylinders

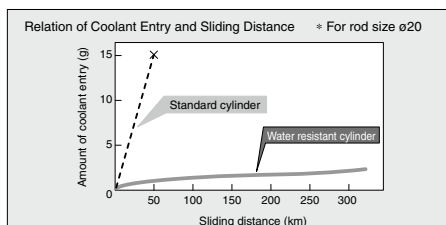

Conditions

Operating conditions..... Air
 Pressure 0.5 MPa
 Coolant Water-soluble
 Piston speed 200 mm/sec
 Operating cycle 60 cpm

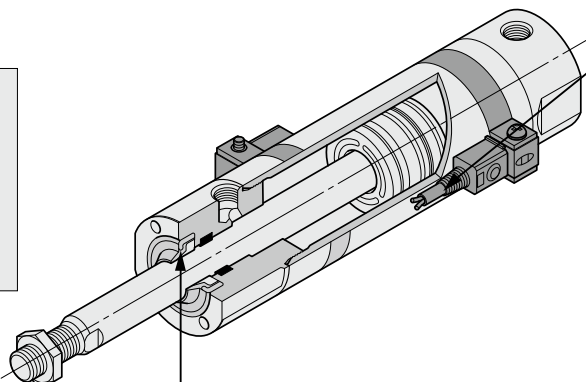
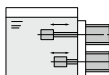

- Two types of standard seal material

Nitrile rubbers (NBR)
 Fluororubbers (FKM)

Mounting brackets, accessories, and nut material: Stainless steel

The following accessories need to be prepared separately. (Please order separately.)
 Refer to the "Accessories" page of each series for details.

Series	Bore size (mm)	Foot	Flange	Single knuckle joint	Double knuckle joint	Mounting nut	Rod end nut	Accessories page
CM2	20, 25, 32, 40	○	○	○	○	○	○	p. 254
CG1	20, 25, 32, 40, 50, 63, 80, 100	○*	○*	○	○	—	○	p. 396
CQ2	20, 25, 32, 40, 50, 63, 80, 100	—	—	○	○	—	○	p. 899

* Except bore size 20 and 25.

Applicable Cylinder

Air Cylinder

CM2 Series
 $\phi 20$ to $\phi 40$



CG1 Series
 $\phi 32$ to $\phi 100$



Air cylinder MB Series
 $\phi 32$ to $\phi 100$









Square tube type air cylinder MB1 Series
 $\phi 32$ to $\phi 100$



Compact cylinder CQ2 Series
 $\phi 20$ to $\phi 100$



Water resistant 2-color indicator solid state auto switch

Model	Applicable cylinder	Lead wire
D-F7BA(V)/L/ Rail mounting 	CQ2 (ø20 to ø100) MK (ø16 to ø63) RSQ (ø32 to ø50)	Oilproof vinyl cabtire cord: ø3.4 0.2 mm ² , 2 cores (Brown, Blue), 3 m (standard)
D-F5BAL/ Tie-rod mounting 	MB (ø32 to ø100) CA2 (ø40 to ø100) CH2F (ø32 to ø100)	Oilproof vinyl cabtire cord: ø4, 0.3 mm ² 2 cores (Brown, Blue), 3 m (standard)
D-H7BAL/ Band mounting 	CM2 (ø20 to ø40) CG1 (ø32 to ø63) MGG (ø32 to ø63)	Oilproof vinyl cabtire cord: ø3.4 0.2 mm ² , 2 cores (Brown, Blue), 3 m (standard)
D-G5BAL/ Band mounting 	CG1(ø80, ø100) MGG(ø80, ø100)	Oilproof vinyl cabtire cord: ø4, 0.3 mm ² 2 cores (Brown, Blue), 3 m (standard)
D-Y7BAL/ Direct mounting <small>Note 1)</small> 	MB (ø32 to ø100) MB1 (ø32 to ø100) CA2 (ø40 to ø100) CHKDB (ø32 to ø100)	Oilproof vinyl cabtire cord: ø3.4 0.15mm ² , 2 cores (Brown, Blue), 3 m (standard)
D-M9□A(V)L/ Direct mounting <small>Note 1)</small> 	CM2 (ø20 to ø40) CG1 (ø32 to ø63) MB (ø32 to ø100) MB1 (ø32 to ø100) CA2 (ø40 to ø100) CQ2 (ø20 to ø100) MGF (ø20 to ø100) MK (ø16 to ø63) RSQ (ø32 to ø50) CHKDB (ø20 to ø100)	Oilproof vinyl cabtire cord: 2.7 x 3.2 Elliptical shape, 0.15 mm ² , 2 cores (D-M9BA(V)), 3 cores (D-M9NA(V), D-M9PA(V))

Note 1) Tie-rod mounting for CA2 and MB

Note 2) This product is not made to be used in water.

Refer to pages 1271 to 1365 for the detailed specifications of auto switches.

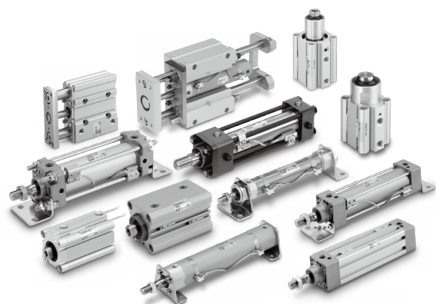

Hydraulic Cylinders

Compact hydraulic cylinder conforming to JIS/10 MPa

CHKDB Series
ø20 to ø100



Hydraulic cylinder conforming to JIS/7 MPa

CH2F Series
ø32 to ø100



CA2 Series
ø40 to ø100



Compact guide cylinder
MGP Series
ø20 to ø100



Guide cylinder
MGG Series
ø32 to ø100

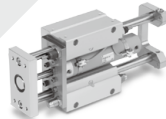

Rotary clamp cylinder
MK Series
ø16 to ø63



Stopper cylinder
RSQ Series
ø32 to ø50



Air Cylinders

CM2 Series $\phi 20$ to $\phi 40$

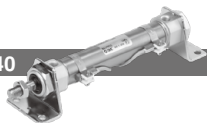

How to Order

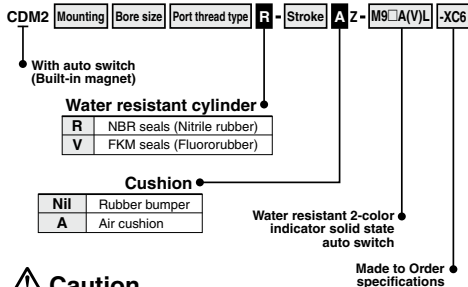

Caution

Rod seals and scrapers are not replaceable. The above parts cannot be replaced since the scraper is press-fit in the rod cover.

Specifications

Action	Double acting, Single rod
Bore size (mm)	20, 25, 32, 40
Cushion	Rubber bumper, Air cushion
Auto switch mounting	Band mounting
Made to Order	Made of stainless steel (-XC6)

* Specifications other than above are the same as standard, basic type.

Dimensions

Male rod end

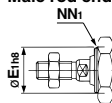

Female rod end

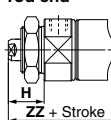

Bore size (mm)	E ₁	NN ₁	H	ZZ
20	22 $\frac{0}{-0.033}$	M22 x 1.5	24	99
25	*26 $\frac{0}{-0.033}$	*M26 x 1.5	24	99
32	*26 $\frac{0}{-0.033}$	*M26 x 1.5	24	101
40	*32 $\frac{0}{-0.039}$	*M32 x 2	26	130

* Other specifications are the same as the double acting, single rod standard type. (An asterisk means it is the same as the standard type.)

Mounting Bracket*: Part No.

Mounting bracket	Min. order qty.	Bore size (mm)		Description (At min. order qty.)
		20		
Axial foot type**	2	CM-L020C		2 foots, 1 mounting nut
Flange	1	CM-F020C		1 flange
Trunnion (with nuts)	1	CM-T020C		1 trunnion, 1 trunnion nut

* The brackets for $\phi 25$ to $\phi 40$ are the same for the standard type.

** Order 2 foot brackets for each cylinder unit.

1192

CG1 Series $\phi 32$ to $\phi 100$



How to Order

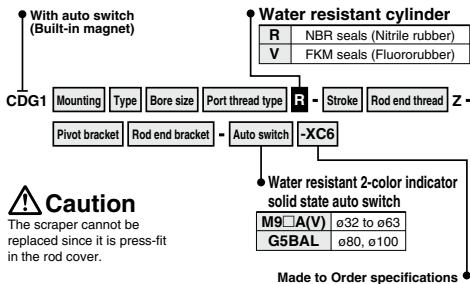

Caution

The scraper cannot be replaced since it is press-fit in the rod cover.

Specifications

Action	Double acting, Single rod
Bore size (mm)	32, 40, 50, 63, 80, 100
Cushion	Rubber bumper, Air cushion
Auto switch mounting	Band mounting
Made to Order	Made of stainless steel (-XC6)

* Specifications other than above are the same as standard, basic type.

Dimensions

Rubber bumper

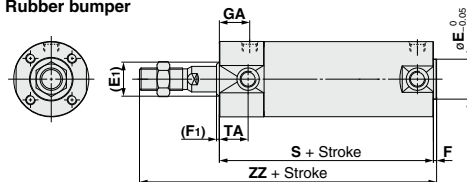

Air cushion

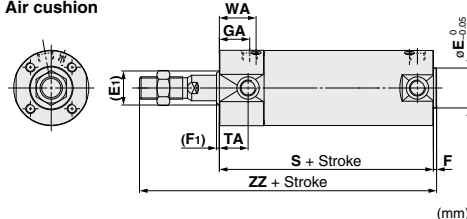

Bore size (mm)	(E ₁)	E*	(F ₁)	F*	GA	S	TA	WA	ZZ
32	17	18	2	2	18	77 (85)	17	22	119 (127)
40	21	25	2	2	19	84 (93)	18	23	136 (145)
50	26	30	2	2	21	97 (109)	20	25	157 (169)
63	26	32	2	2	21	97 (109)	20	25	157 (169)
80	32	40	3	3	28	116 (130)	—	32	190 (204)
100	37	50	3	3	29	117 (131)	—	33	191 (205)

* Other specifications are the same as the double acting, single rod standard type. (An asterisk means it is the same as the standard type.)

* (): For the long stroke type

Air Cylinders

MB

Series

ø32 to ø100



How to Order

MDB [Mounting] [Bore size] [Port thread type] **R** - Stroke Z - M9□A(V)L -XC68

• With auto switch
(Built-in magnet)

Water resistant cylinder

R	NBR seals (Nitrile rubber)
V	FKM seals (Fluororubber)

• **Water resistant 2-color
indicator solid state
auto switch**

• **Made to Order
specifications**

MB1

Series

ø32 to ø100



How to Order

MDB1 [Mounting] [Bore size] [Port thread type] **R** - Stroke Z - M9□A(V)L -XC68

• With auto switch
(Built-in magnet)

Water resistant cylinder

R	NBR seals (Nitrile rubber)
V	FKM seals (Fluororubber)

• **Water resistant 2-color
indicator solid state
auto switch**

• **Made to Order
specifications**

Specifications

Action	Double acting, Single rod
Bore size (mm)	ø32, 40, 50, 63, 80, 100
Cushion	Air cushion, Rubber bumper
Auto switch mounting	Tie rod mounting
Made to Order	Made of stainless steel (-XC68)

* Specifications other than above are the same as standard, basic type.

Specifications

Action	Double acting, Single rod
Bore size (mm)	ø32, 40, 50, 63, 80, 100
Cushion	Air cushion, Rubber bumper
Auto switch mounting	Direct mounting
Made to Order	Made of stainless steel (Piston rod is hard chrome plated) (-XC68)

* Specifications other than above are the same as standard, basic type.

Dimensions

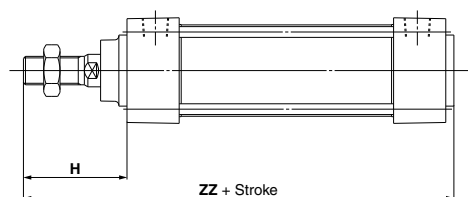

Bore size (mm)	H	ZZ
32	47	135 (141)
40	58	146 (152)
50	67	165 (173)
63	67	165 (173)
80	81	199 (209)
100	81	199 (209)

* Other specifications are the same as the double acting, single rod standard type.

* () : For the type without a rubber bumper

Dimensions

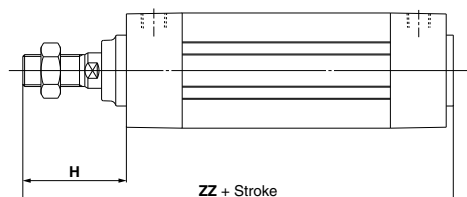

Bore size (mm)	H	ZZ
32	47	135 (141)
40	58	146 (152)
50	67	165 (173)
63	67	165 (173)
80	81	199 (209)
100	81	199 (209)

* Other specifications are the same as the double acting, single rod standard type.

* () : For the type without a rubber bumper

Air Cylinders

Compact Cylinder

CQ2 Series $\varnothing 20$ to $\varnothing 100$



How to Order

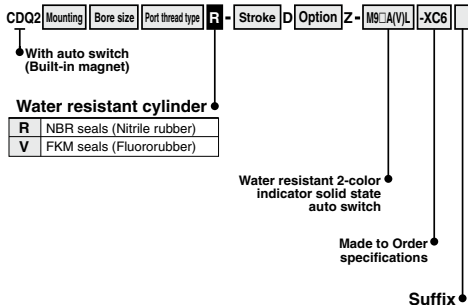

Specifications

Action	Double acting, Single rod
Bore size (mm)	20, 25, 32, 40, 50, 63, 80, 100
Mounting	$\varnothing 20$ to $\varnothing 32$ B (through-hole) only $\varnothing 40$ to $\varnothing 100$ B (through-hole), F (rod side flange) A (both ends tapped), G (head side flange) L (foot), D (double clevis)
Cushion	None
Minimum operating pressure	0.08 MPa
Auto switch mounting	Rail mounting (D-F7BAL/F7BAVL)/Direct mounting (D-M9□A(V)L) Use auto switch brackets for rail mounting.
Made to Order	Retaining ring, piston rod, rod end nut material: Stainless steel (-XC6)

* Specifications other than above are the same as standard, basic type.

Refer to page 972 for details.

CA2 Series $\varnothing 40$ to $\varnothing 100$



How to Order

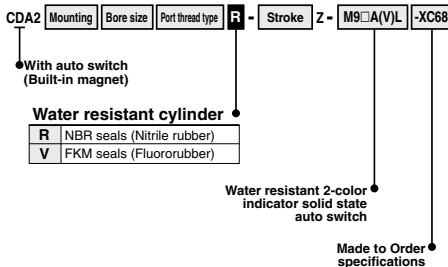

Specifications

Action	Double acting, Single rod
Bore size (mm)	40, 50, 63, 80, 100
Cushion	Air cushion
Auto switch mounting	Tie-rod mounting type
Made to Order	Made of stainless steel (Piston rod is hard chrome plated) (-XC68)

* Specifications other than above are the same as standard, basic type.

Note 1) Air-hydro type, rod boot specifications are excluded.

Note 2) Combination of auto switches and steel tube is not available.

Dimensions

* Other specifications are the same as the double acting, single rod standard type.

Air Cylinders

Compact guide cylinder

MGP Series $\phi 20$ to $\phi 100$



How to Order

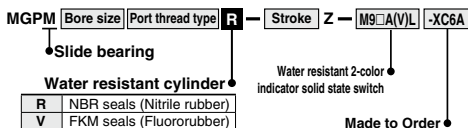

* Piston rod and guide rod are made of stainless steel.

Specifications

Applicable series	MGM		
Bearing type	Slide bearing		
Bore size (mm)	20, 25, 32, 40, 50, 63, 80, 100		
Cushion	MGPM□□R	Rubber bumper	
	MGPM□□V	Without cushion	
Auto switch mounting	Direct mounting		
Minimum operating pressure	0.13 MPa		
Made to Order	-XC6A	Specified parts made of stainless steel	

* Specifications other than above are the same as standard, basic type. (Note) Refer to the **Web Catalog** for details.

Dimensions

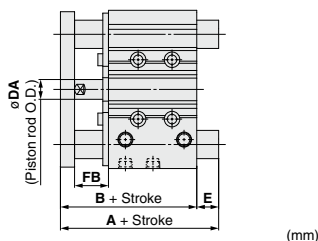

Bore size (mm)	A			B	DA
	50 st or less	Over 50 st 200 st or less	Over 200 st		
20	66	90.5	123	66	(10)
25	67.5	91.5	123.5	67.5	(10)
32	87	105.5	141.5	71.5	(14)
40	87	105.5	141.5	78	(14)
50	99.5	120.5	161.5	83	20
63	99.5	120.5	161.5	88	20
80	110.5	137.5	186.5	102.5	25
100	130.5	155.5	194.5	120	30

Bore size (mm)	E			FB	XC6A	
	50 st or less	Over 50 st 200 st or less	Over 200 st		FB	FB
20	(0)	(24.5)	(57)	21	20	
25	(0)	(24)	(56)	21	20	
32	(15.5)	(34)	(70)	24	22	
40	(9)	(27.5)	(63.5)	24	22	
50	(16.5)	(37.5)	(78.5)	27	23	
63	(11.5)	(32.5)	(73.5)	27	23	
80	(8)	(35)	(84)	30	27	
100	(10.5)	(35.5)	(74.5)	35	32	

* The dimensions in () are the same as standard type.

* The FB dimensions change for the XC6A.

Guide cylinder

MGG Series $\phi 32$ to $\phi 100$

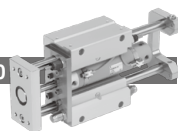

How to Order

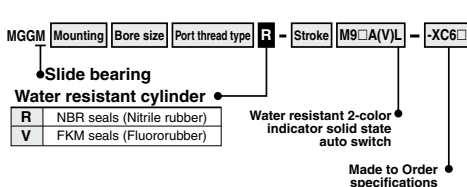

* A scraper is installed on piston rod parts only.

Specifications

Action	Double acting	
Bore size (mm)	32, 40, 50, 63, 80, 100	
Bearing type	Slide bearing	
Cushion	Built-in rubber bumper and shock absorber	
Auto switch mounting	Band mounting	
Made to Order	-XC6	Made of stainless steel (Piston rod, rod end nut)
	-XC6A	Stainless steel used on all iron parts
	-XC6B	Stainless steel rod end moving parts
	-XC6C	Stainless steel rods

* Specifications other than above are the same as standard, basic type. Refer to the **Web Catalog** for details.

(Note) RBL (anti-coolant) type is used for shock absorbers.

Dimensions

(Dimensions other than the below are the same as the standard type.)

$\phi 32$ to $\phi 50$

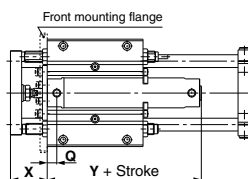

$\phi 63$ to $\phi 100$

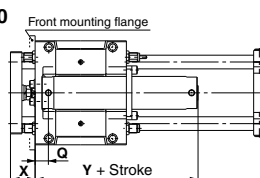

Bore size (mm)	Q	X	Y
32	16	48	77 (85)
40	17	58	84 (93)
50	19	69	97 (109)
63	34	56	112 (124)
80	46	68	137 (151)
100	47	68	138 (152)

* (): For the long stroke type.

Air Cylinder

MK Series

ø16 to ø63



How to Order

MK [Mounting] [Bore size] [Port thread type] **R** - [Clamp stroke] [Rotary direction] [Body option] Z - M9□A(V)L

Bore size

16	16 mm
20	20 mm
25	25 mm
32	32 mm
40	40 mm
50	50 mm
63	63 mm

Water resistant cylinder

R	NBR seals (Nitrile rubber)
V	FKM seals (Fluororubber)

Water resistant 2-color
indicator solid state auto switch

Specifications

Bore size (mm)	16 20 25 32 40 50 63
Action	Double acting
Cushion	Rubber bumper
Minimum operating pressure	0.15 MPa (0.1 MPa)
Auto switch mounting	Direct mounting

- * Specifications other than above are the same as standard, basic type.
- * Excludes bore sizes ø16 to ø25 of the rod flange type
- * The dimensions in () are the same as standard type.

Dimensions

ø16

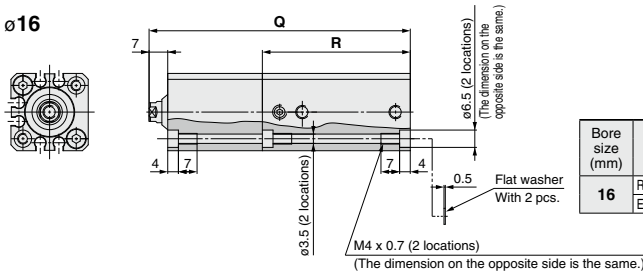

Bore size (mm)	Rod state	Clamp stroke					
		10 mm		20 mm		30 mm	
		Q	R	Q	R	Q	R
16	Retracted	78	45.5	98	55.5	118	65.5
	Extended	95.5		125.5		155.5	

ø20, ø25

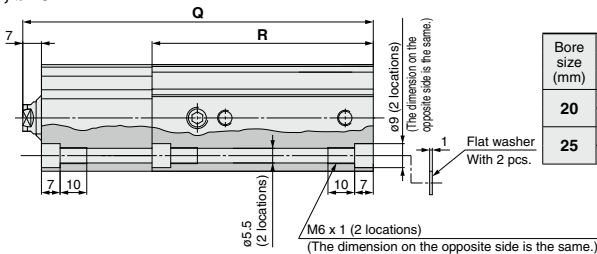

Bore size (mm)	Rod state	Clamp stroke					
		10 mm		20 mm		30 mm	
		Q	R	Q	R	Q	R
20	Retracted	99	72	119	82	139	92
	Extended	118.5		148.5		178.5	
25	Retracted	111.5	73	131.5	83	151.5	93
	Extended	131		161		191	

ø32 to ø63

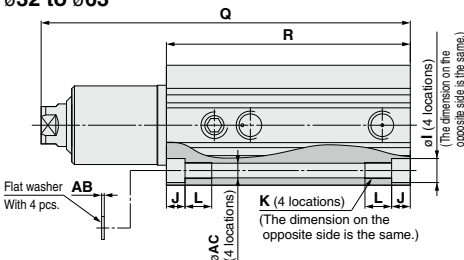

Bore size (mm)	Rod state	Clamp stroke								I	J	K	L	AB	øAC
		10 mm		20 mm		30 mm		50 mm							
		Q	R	Q	R	Q	R	Q	R						
32	Retracted	118.5	81.5	138.5	91.5	158.5	101.5	198.5	121.5	9	7	M6 x 1.0	10	1	5.5
	Extended	143.5		173.5		203.5		263.5							
40	Retracted	119	75	139	85	159	95	199	115	9	7	M6 x 1.0	10	1	5.5
	Extended	144		174		204		264							
50	Retracted	137	86.5	157	96.5	177	106.5	217	126.5	11	8	M8 x 1.25	14	1	6.6
	Extended	166		196		226		286							
63	Retracted	140	90	160	100	180	110	220	130	14	10.5	M10 x 1.5	18	1.4	9
	Extended	169		199		229		289							

Air Cylinder

RSQ Series $\phi 32$ to $\phi 50$



How to Order

RSDQ [Mounting] [Bore size] **R** - Stroke D Z - [Mounting bolt] - [M9]A(V)L [Suffix]

• With auto switch
(Built-in magnet)

• Action

D Double acting

• Water resistant cylinder

R	NBR seals (Nitrile rubber)
V	FKM seals (Fluororubber)

Water resistant 2-color indicator,
solid state auto switch

Specifications

Action	Double acting
Bore size (mm)	$\phi 32$, $\phi 40$, $\phi 50$
Cushion	Rubber bumper
Rod end configuration	Round bar
Auto switch mounting	Direct mounting

* Specifications other than the above are the same as the standard type.

Dimensions

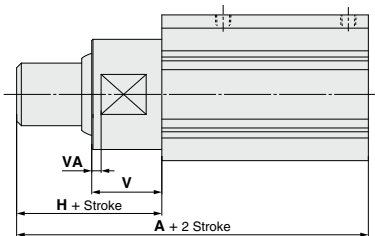

(mm)				
Bore size	A	H	V	VA
32	80	32	24	8
40	89.5	37	29	0
50	91	37	29	0

* Other specifications are the same as the double acting.

Hydraulic Cylinders

Compact hydraulic cylinder conforming to JIS/10 MPa

CHKD Series $\phi 20$ to $\phi 100$



Hydraulic cylinder conforming to JIS/7 MPa

CH2F Series $\phi 32$ to $\phi 100$



How to Order

CHDKDB Bore size Port thread type R Stroke End thread type M9□A(V)L

With auto switch (Built-in magnet)

Water resistant cylinder

R NBR seals (Nitrile rubber)
V FKM seals (Fluororubber)

* Piston seal is made of NBR for both R and V.

Water resistant 2-color indicator solid state auto switch

* The piston rod material of $\phi 20$ and $\phi 25$ is stainless steel. For $\phi 32$ or more, the stainless steel piston rods are available as made to order.

Specifications

Action	Double acting, Single rod
Bore size (mm)	20, 25, 32, 40, 50, 63, 80, 100
Cushion	None
Auto switch mounting	Direct mounting

* Specifications other than above are the same as standard, basic type.

Dimensions

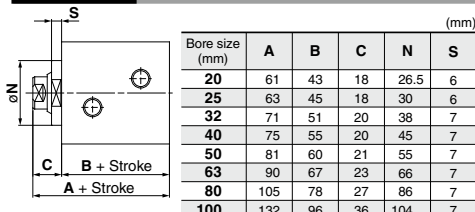

* Other specifications are the same as the double acting, single rod standard type.

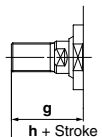

Rod end male thread

* Other specifications are the same as the double acting, single rod standard type.

How to Order

CHD2F Mounting Bore size Rod series R Stroke Option F5BAL

With auto switch (Built-in magnet)

Water resistant cylinder

R NBR seals (Nitrile rubber)
V FKM seals (Fluororubber)

* Piston seal is made of NBR for both R and V.

Port position

Water resistant 2-color indicator solid state auto switch

* Stainless steel piston rods are available as made to order.

Specifications

Action	Double acting, Single rod
Bore size (mm)	32, 40, 50, 63, 80, 100
Cushion	Cushion seal type
Auto switch mounting	Tie-rod mounting

* Specifications other than above are the same as standard, basic type.

Dimensions

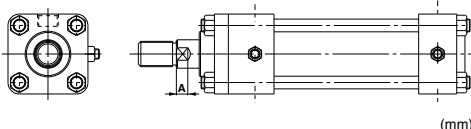

* Other specifications are the same as the double acting, single rod standard type.



Water Resistant Air Cylinder/Water Resistant Hydraulic Cylinder

Specific Product Precautions

Be sure to read this before handling the products. Refer to page 20 for safety instructions and pages 21 to 30 for actuator and auto switch precautions.

Handling Precautions

1. Before installing a cylinder, thoroughly flush out the piping to prevent dust or cutting chips from entering the cylinder. For the hydraulic cylinder, use the air bleed valve to bleed the air inside the cylinder.
2. Eccentric loads applied to the piston rod dramatically shorten the service life. Use the piston rod by always applying a load in an axial direction.
3. Make sure not to scratch or gouge the sliding portion of the piston rod, as this could damage the seals and lead to leaks. Attach a cover or other protection in locations where the cylinder is exposed to grinding sludge or machining chips.
4. When the cylinder is used in a place where the liquid from the piston rod is lightly splashed, and exposed to dust or sand, use a heavy duty scraper (-XC4).
5. If there is a possibility that liquid splashes on cylinder fittings when using an air cylinder, use insert fittings, self-align fittings, piping, etc. Consider the compatibility of liquid components and piping materials before using.
6. When selecting seals, generally use NBR (nitrile rubber) seals with liquids that do not contain chlorine and sulfur, and use FKM (fluororubber) seals with liquids that contain chlorine and sulfur. However, depending on the type and the brand of liquid that splashes on the cylinder, the operating life of seals may be reduced dramatically (such as coolant liquid). In cases where special additives are used, or where liquid caused trouble with the current nitrile or fluororubber seals in the past, request an investigation or set up a test period for the use of the seals.

Examples of coolants

- | | | |
|----------------------|---------------------------------------|-------------|
| Shimiron, PA-O-5 | (Daido Chemical Industry Co., Ltd.) | (NBR seals) |
| Noritake Cool, AFG-S | (Noritake Co., Ltd.) | (NBR seals) |
| Yushiroken, S-46S | (Yushiro Chemical Industry Co., Ltd.) | (NBR seals) |
| Yushiroken, EC-50-T3 | (Yushiro Chemical Industry Co., Ltd.) | (NBR seals) |
| Yushiron Oil, No. 23 | (Yushiro Chemical Industry Co., Ltd.) | (FKM seals) |
| Daphne Cut, Hs-1 | (Idemitsu Kosan Co., Ltd.) | (FKM seals) |
7. Please consult with SMC separately when liquid contains sulfur, which is used for cylinders with a guide (MGP, MGG).