

Magnetically Coupled Rodless Cylinder

CY1S Series

ø6, ø10, ø15, ø20, ø25, ø32, ø40

RoHS

Weight

Max. **15%** reduced

0.96 kg (Current model 1.13 kg)
(CY1S 15-100 stroke)

Overall length

Max. **15 mm** shortened

240 mm (Current model 255 mm)
(CY1S 40-100 stroke)

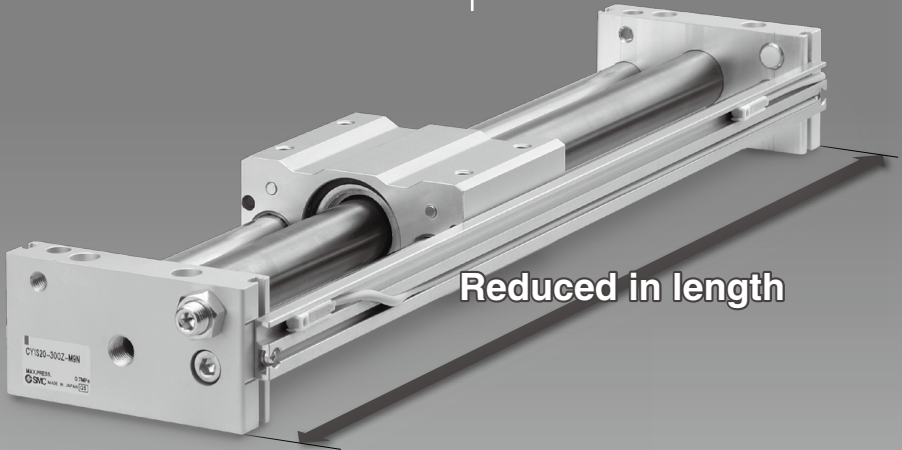

Improved durability

Lube-retainers are mounted on the internal and external surfaces of the cylinder tube to maintain the lubrication.

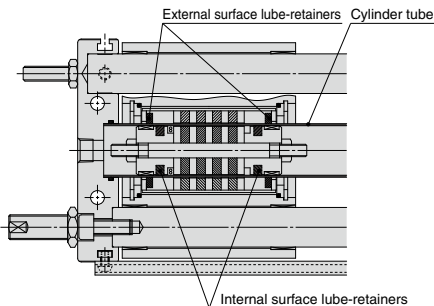

Adjustment bolt improves stroke accuracy/repeatability.

Stroke position can be maintained with the adjustment bolt positioned next to the shock absorber, so stroke adjustment is not necessary.

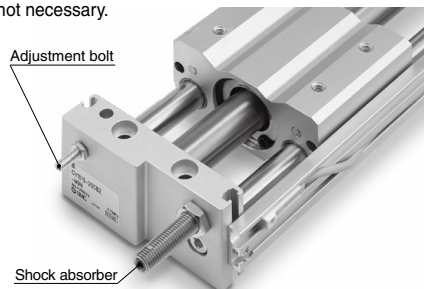

Reduced in weight

Weight is reduced with the redesign of the slide block and reducing the thickness of the plate.

Bore size (mm)	CY1S	Reduction rate	Current model (kg)
6	0.34	8%	0.37
10	0.59	13%	0.68
15	0.96	15%	1.13
20	1.68	13%	1.93
25	2.02	10%	2.25
32	3.45	12%	3.94
40	5.36	14%	6.23

* At 100 stroke

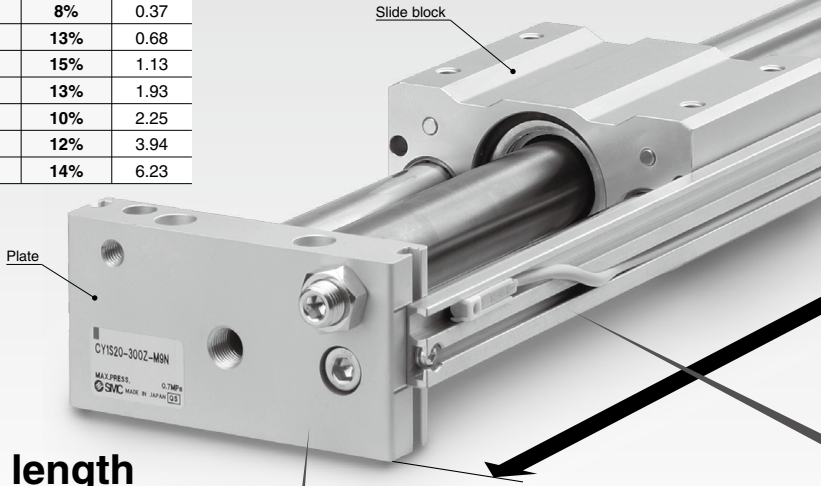

Reduced in length

Overall length is reduced, but interchangeable with the current model.

Bore size (mm)	CY1S				Current model
	Bilateral piping type		Centralized piping type		
	Overall length	Length reduction	Overall length	Length reduction	Overall length
6	162	6	166	2	168
10	172	8	176	4	180
15	187	10	192	5	197
20	206	9	211	4	215
25	206	9	211	4	215
32	228	10	234	4	238
40	240	15	246	9	255

* At 100 stroke

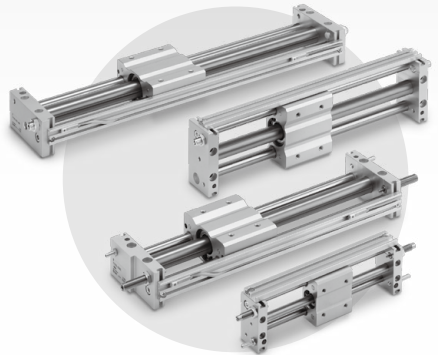

Bilateral piping and centralized piping versions available

• Bilateral piping type

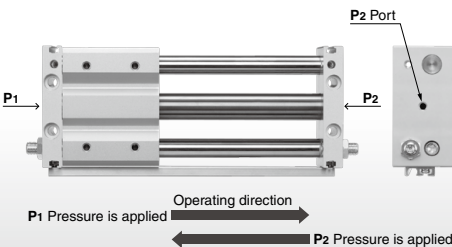

• Centralized piping type

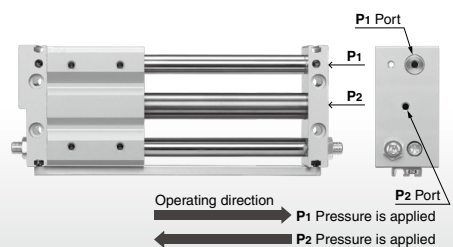

Magnetically Coupled Rodless Cylinder

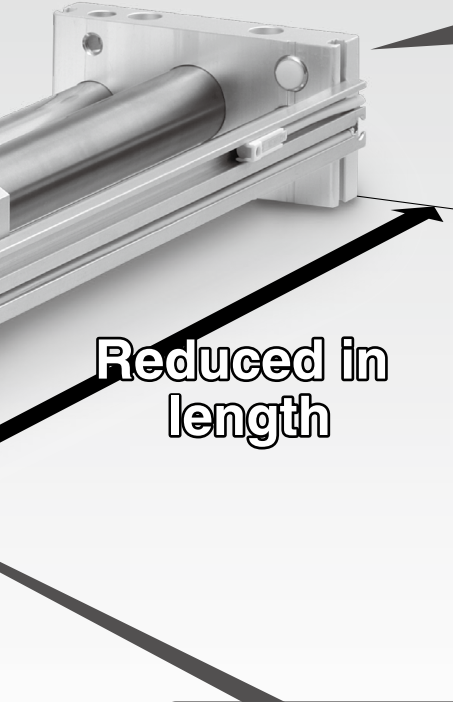

Reduced in length

3-Options available for stroke adjustment

• Bumper bolt (resin tipped)

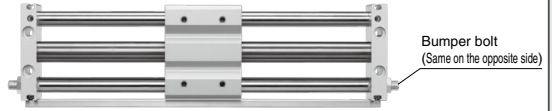

• Shock absorber + Adjustment bolt (metal ended)

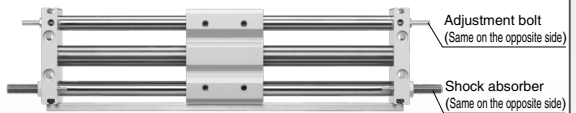

• Shock absorber + Adjustment bolt (metal ended) on one side • Bumper bolt (resin tipped) on one side

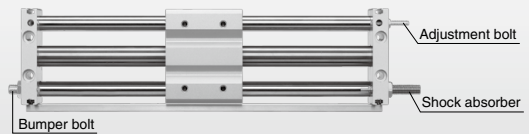

Improved auto switch mounting

1 Auto switch can be mounted in any desired position. (D-M9□, D-A9□)

- The auto switch can be fixed in any desired position with a switch spacer.
- This reduces man-hours for mounting.

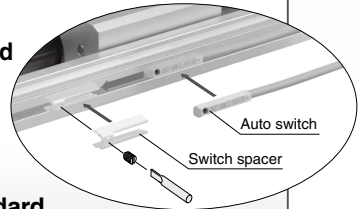

2 Auto switch mounting rail fitted as standard

Auto switch rail is suitable for various switch specifications. Refer to page 1 for applicable auto switches.

Shock absorber

The RJ series soft stop shock absorbers fitted as standard

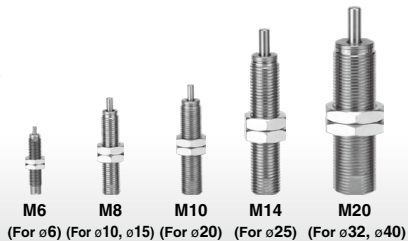

CY1S Series Model Selection

Selection Flow Chart

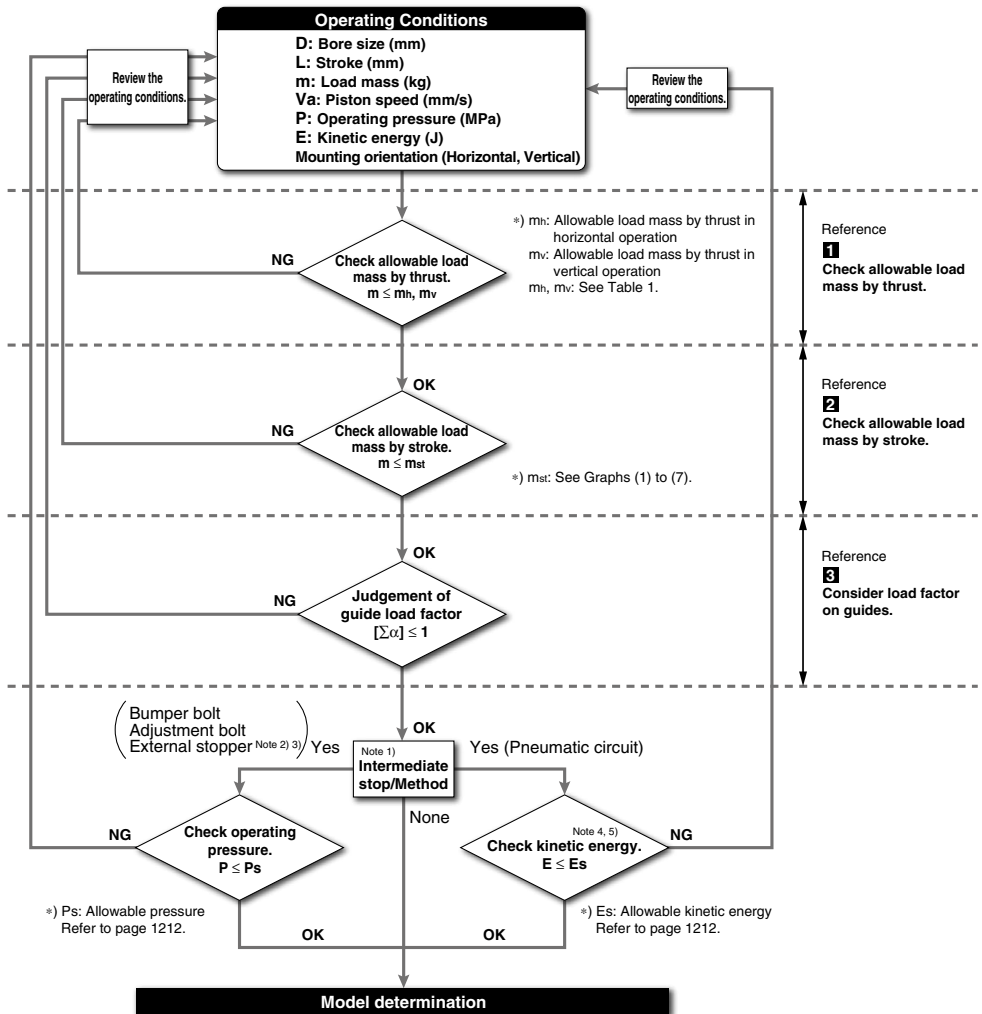

Note 1) Stroke adjustment with either a bumper bolt or adjustment bolt is considered as an intermediate stop.

Note 2) When an intermediate stop is performed with an external stopper, consider the dynamic load as shown below.

- Bumper bolt: $\delta = 4/100$
- Shock absorber and air cushion: $\delta = 1/100$

In addition to this, check the judgement results of the guide load factor. (δ : Bumper coefficient)

Note 3) When an external stopper is used in conjunction with a shock absorber, check the model selection of shock absorber separately.

Note 4) This cylinder cannot perform an intermediate stop with the pneumatic circuit in vertical operation.

The intermediate stop is only performed with a bumper bolt, adjustment bolt or external stopper.

Note 5) When an intermediate stop is performed with the pneumatic circuit, the stopping accuracy may vary significantly.

If accuracy is required, be sure to perform the intermediate stop with a bumper bolt, adjustment bolt or external stopper.

1 Check allowable load mass by thrust.

In this series, the work load and the maximum operating pressure are restricted to prevent the magnetic coupling from being separated. Ensure that the work load mass and operating pressure are within the values in Table 1.

Table 1. Allowable load mass by thrust and maximum operating pressure

Bore size (mm)	Horizontal operation m_h [kg]	Horizontal operation Max. operating pressure P_h [MPa] ^{Note)}	Vertical operation m_v [kg]	Vertical operation Max. operating pressure P_v [MPa]
6	1.8	0.70	1.0	0.55
10	3.0		2.7	
15	7.0		7.0	0.65
20	12		11	
25	20		18.5	
32	30		30	
40	50	47		

Note) Without stroke adjustment

When stroke adjustment is performed with bumper bolt, adjustment bolt, or intermediate stop is performed with an external stopper, the maximum operating pressure should be as shown in the page 1212.

2 Check allowable load mass by stroke.

In this series, guide shafts are assembled to support the load.

Deflection of the guide shaft increases due to work load mass and rolling moment (M_2), so the work load mass and stroke is restricted. Check that the load mass is within the allowable load mass by stroke: m_{st} from Graphs (1) to (7) for each bore size.

[Horizontal mounting and Ceiling mounting]

The allowable load mass by stroke range varies depending on the y direction of the loads center of gravity.

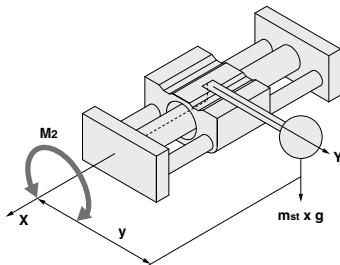

[Wall mounting]

The allowable load mass by stroke range varies depending on the z direction of the loads center of gravity.

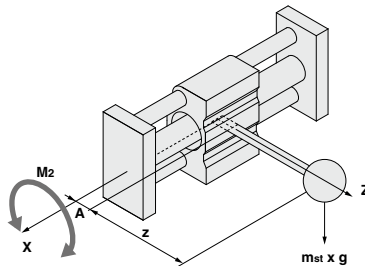

[Vertical mounting]

Load mass is not restricted by stroke.

A: Distance between the center of the guide shaft and the upper surface of the slide block

2 Check allowable load mass by stroke.

Selection Graph

[Graph 1] Allowable load mass by stroke ø6

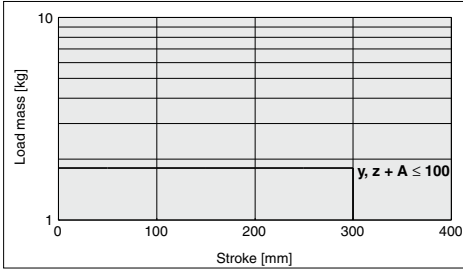

[Graph 2] Allowable load mass by stroke ø10

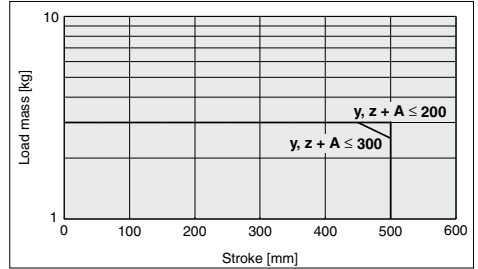

[Graph 3] Allowable load mass by stroke ø15

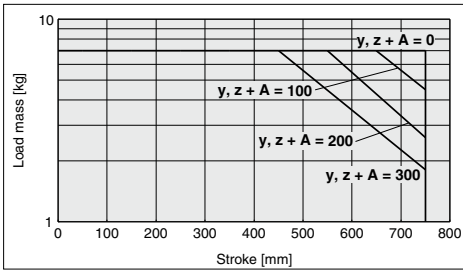

[Graph 4] Allowable load mass by stroke ø20

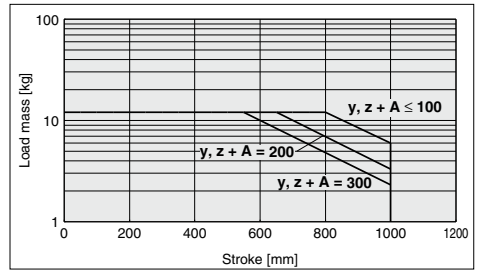

[Graph 5] Allowable load mass by stroke ø25

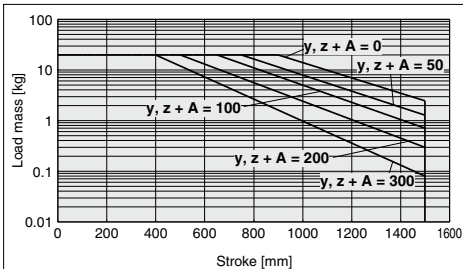

[Graph 6] Allowable load mass by stroke ø32

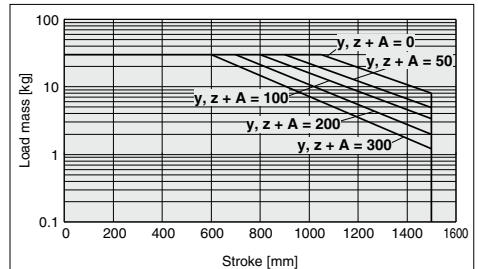

[Graph 7] Allowable load mass by stroke ø40

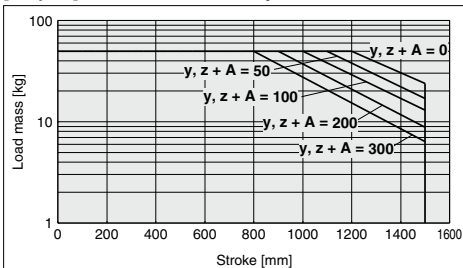

* If load center of gravity exceeds the value of $y, z + A$ on the graph, please consult SMC.

3 Consider load factor on guides.

3-1 Types of moment applied to rodless cylinders

Multiple moments may be generated depending on the mounting orientation, load, and position of the center of gravity.

Coordinates and Moments

* The direction of the axis, X, Y and Z are based on the cylinder mounting orientation shown on the right. Consider the direction of the axis for each mounting direction.

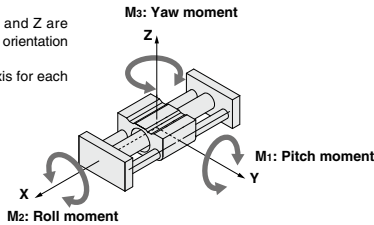

Static moment calculation by mounting type

[Horizontal mounting]

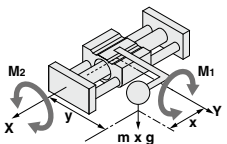

[Ceiling mounting]

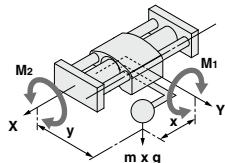

[Wall mounting]

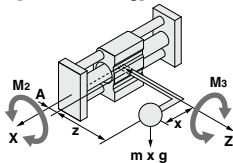

[Vertical mounting]

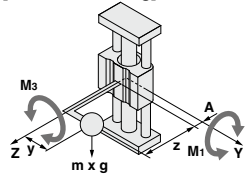

Table 2. Mounting orientation and static moment

Mounting orientation	Horizontal mounting	Ceiling mounting	Wall mounting	Vertical mounting
Static load	m			
Static moment	M1: $m \times g \times x$ M2: $m \times g \times y$ M3: —	M1: $m \times g \times x$ M2: $m \times g \times y$ M3: —	M1: — M2: $m \times g \times (z + A)$ M3: $m \times g \times x$	M1: $m \times g \times (z + A)$ M2: — M3: $m \times g \times y$

* A: Distance between the center of the guide shaft and the upper surface of the slide block (See the table on the right.)

Bore size (mm)	A [mm]
6	19
10	21
15	25
20	27
25	33
32	40
40	49

Dynamic moment calculation by mounting type

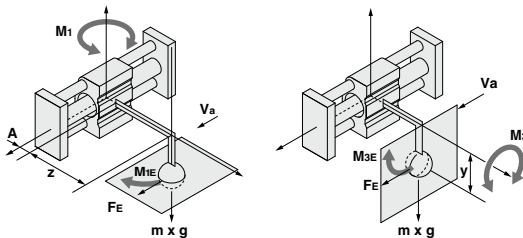

Table 3. Mounting orientation and dynamic moment

Mounting orientation	Horizontal mounting	Ceiling mounting	Wall mounting	Vertical mounting
Dynamic load	$\delta \times 1.4 \times Va \times m \times g$		Bumper bolt: $\delta = 4/100$ Shock absorber: $\delta = 1/100$	
Dynamic moment	M1E: $1/3 \times FE \times x$ M2E: — M3E: —	M1E: $1/3 \times FE \times x$ M2E: — M3E: —	Dynamic moment does not occur.	
	$1/3 \times FE \times y$			

Regardless of the mounting orientation, dynamic moment is calculated with the formulas above.

3 Consider load factor on guides.

3-2 Allowable load mass on guides/Allowable moment

Table 4. Allowable load mass on guides and moment

Bore size (mm)	Allowable load mass on guides m [kg]	Allowable moment [N·m]		
		M ₁	M ₂	M ₃
6	9	1.3	1.4	1.3
10	15	2.6	2.9	2.6
15	35	8.6	8.9	8.6
20	60	17	18	17
25	104	30	35	30
32	195	67	82	67
40	244	96	124	96

The table above indicates the maximum performance of the guide, but does not show the actual allowable work load mass. Refer to Graphs (8) to (13) for correct allowable mass by piston speed.

[Graph 8] Allowable load mass on guides (ø6 to ø15) m

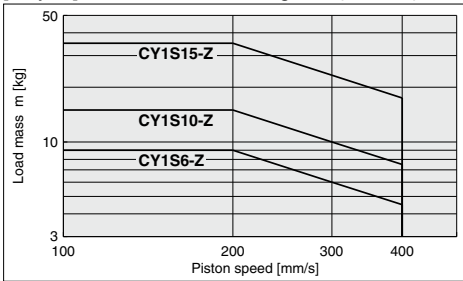

[Graph 9] Allowable load mass on guides (ø20 to ø40) m

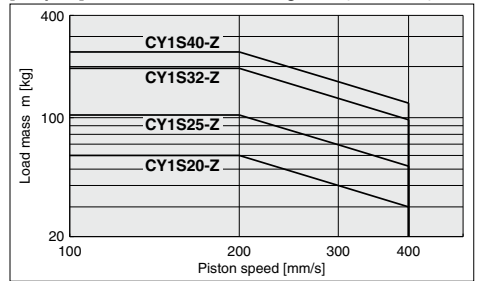

[Graph 10] Allowable moment (ø6 to ø15) M₁, M₃

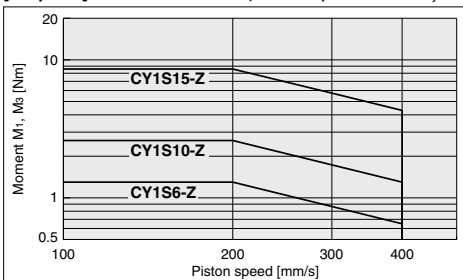

[Graph 11] Allowable moment (ø20 to ø40) M₁, M₃

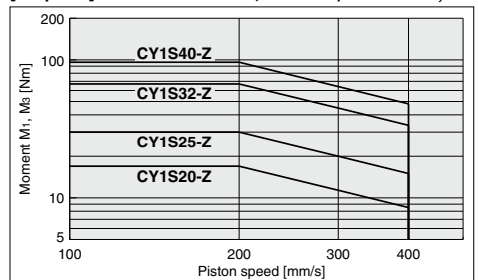

[Graph 12] Allowable moment (ø6 to ø15) M₂

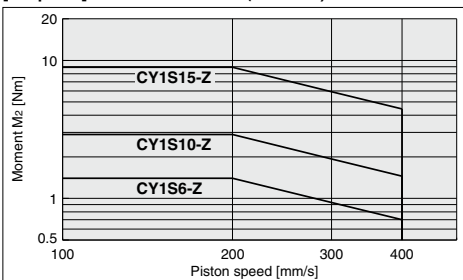

[Graph 13] Allowable moment (ø20 to ø40) M₂

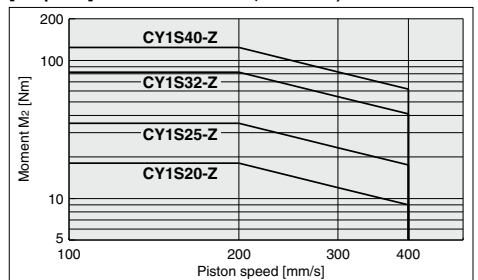

3-③ Consideration of guide load factor

Work load mass and allowable moment varies depending on the load mounting method, stroke, cylinder mounting orientation and piston speed.

Whether the cylinder is suitable or not is decided by the allowable load mass on guides in the graphs.

The selection calculation is shown below.

It is necessary to consider i) allowable load mass on guides, ii) static moment and iii) dynamic moment (when the slide block collides with the stopper).

* i) - ii) is calculated with Va (average speed) and iii) is calculated with V (collision speed $V = 1.4V_a$).

Calculate m_{max} of i) from the allowable load mass on guides in Graphs (8) and (9), and calculate M_{max} of ii) and iii) from the allowable moment (M_1, M_2, M_3) in Graphs (10), (11), (12) and (13).

$$\sum \alpha = \frac{\text{Load mass (m)}}{\text{Allowable load mass on guides (m}_{max})} + \frac{\text{Static moment (M) }^{Note\ 1}}{\text{Allowable static moment (M}_{max})} + \frac{\text{Dynamic moment (ME) }^{Note\ 2}}{\text{Allowable dynamic moment (ME}_{max})} \leq 1$$

Note 1) Moment caused by the load etc., with cylinder in resting condition

Note 2) Moment caused by the load equivalent to impact at the stroke end (at the time of impact with stopper)

Note 3) Several moments might be generated depending on the cylinder mounting orientation or the load center of gravity, so the sum of the allowable load mass on guides, allowable static moment and allowable dynamic moment will be the sum of all these guide load factors.

Calculation method to determine the center of gravity when several loads are mounted on the cylinder

When several loads are mounted on the cylinder, it is difficult to calculate the center of gravity.

As shown in the figure below, the center of gravity of the load is calculated from the total load mass and of center of gravity for all the loads.

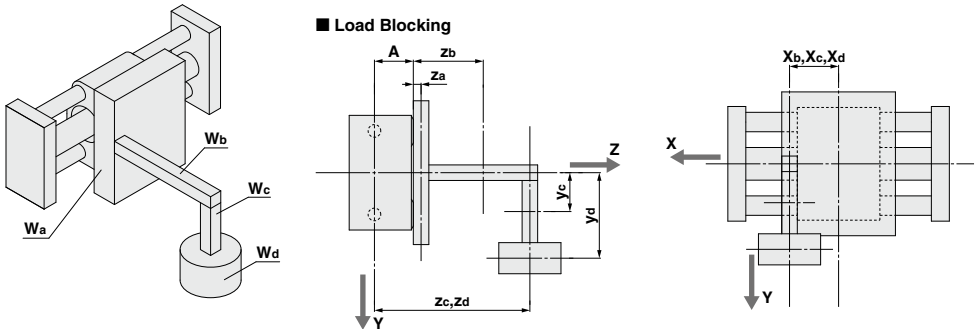

Mass and center of gravity of the load

Load no. W_n	Mass m_n	Center of gravity		
		X-axis x_n	Y-axis y_n	Z-axis z_n
W_a	m_a	x_a	y_a	z_a
W_b	m_b	x_b	y_b	z_b
W_c	m_c	x_c	y_c	z_c
W_d	m_d	x_d	y_d	z_d

Calculation for Overall Center of Gravity

$$m_t = \sum m_n \dots ①$$

$$X = \frac{1}{m_t} \times \sum (m_n \times x_n) \dots \dots \dots ②$$

$$Y = \frac{1}{m_t} \times \sum (m_n \times y_n) \dots \dots \dots ③$$

$$Z = \frac{1}{m_t} \times \sum \{m_n \times (A + z_n)\} \dots ④$$

(n = a, b, c, d)

Refer to the following sections 1 to 4 to calculate the center of gravity and the total load.

Refer to page 1208 for detailed selection procedure.

Calculation of Guide Load Factor

The selection calculation finds the load factors (α_n) of the items below, where the total does not exceed 1.

Item	Load factor α_n	Note
1: Maximum load mass	$\alpha_1 = m/m_{\max}$	Examine m . m_{\max} is the max. load mass for V_a .
2: Static moment	$\alpha_2 = M/M_{\max}$	Examine M_1, M_2, M_3 . M_{\max} is the allowable moment for V_a .
3: Dynamic moment	$\alpha_3 = M_e/M_{e\max}$	Examine M_1e, M_2e . $M_{e\max}$ is the allowable moment for V .

Calculation example 1 Mounting on horizontal wall

[1] Operating Conditions

Cylinder: **CY1SG25-600**
 Cushion: Shock absorber
 Mounting: Horizontal wall mounting
 Speed: $V_a = 250$ [mm/s]

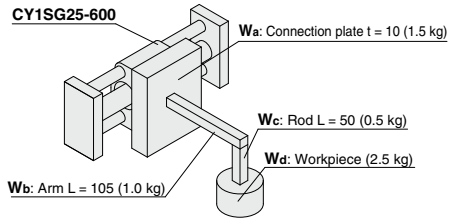

[2] Load Blocking

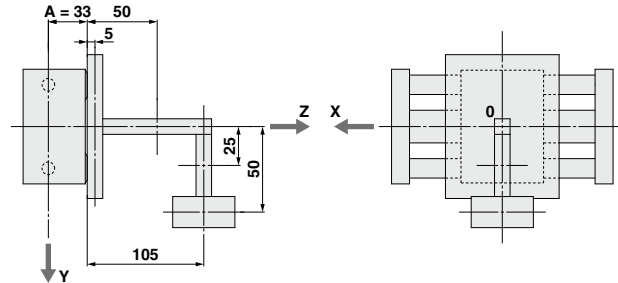

Mass and center of gravity of the load

Load no.	Mass m_n	Center of gravity		
		X-axis x_n	Y-axis y_n	Z-axis z_n
Wa	1.5 kg	0 mm	0 mm	5 mm
Wb	1.0 kg	0 mm	0 mm	50 mm
Wc	0.5 kg	0 mm	25 mm	105 mm
Wd	2.5 kg	0 mm	50 mm	105 mm

$n = a, b, c, d$

[3] Calculation for Overall Center of Gravity

$$\begin{aligned}
 mt &= \sum m_n \\
 &= 1.5 + 1.0 + 0.5 + 2.5 \\
 &= 5.5 \text{ kg} \\
 X &= 0 \text{ mm} \\
 &\text{(The center of gravity in the x direction of all work pieces is 0, so } X = 0 \text{ mm.)} \\
 Y &= \frac{1}{mt} \times \sum (m_n \times y_n) \\
 &= \frac{1}{5.5} \times (1.5 \times 0 + 1.0 \times 0 + 0.5 \times 25 + 2.5 \times 50) \\
 &= 25 \text{ mm} \\
 Z &= \frac{1}{mt} \times \sum \{m_n \times (A + z_n)\} \\
 &= \frac{1}{5.5} \times \{1.5 \times (33 + 5) + 1.0 \times (33 + 50) + 0.5 \times (33 + 105) + 2.5 \times (33 + 105)\} \\
 &= 100 \text{ mm}
 \end{aligned}$$

[4] Check the allowable load.

Item	Result	Note
(1) Check allowable load mass by thrust.	Work load is 5.5 kg < 20 kg. OK	Check allowable load by thrust. The bore size is $\phi 25$, so the allowable load by thrust will be 20 kg.
(2) Allowable load by stroke	Work load is 5.5 kg < 20 kg. OK	The load is restricted to 20 kg when the stroke is 600 mm and $Z = 100$ mm taken from Graph (5) 1 (Refer to page 1209).

[5] Judgement of Guide Load Factor

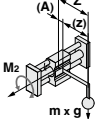
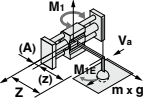
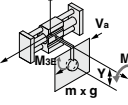
Item	Load factor α_n	Note
1 Load mass 	$\alpha_1 = m/m_{max}$ $= 5.5/83.2$ $= 0.07$	Examine m. Find the value of m_{max} when $V_a = 250$ mm/s from Graph (9) [2].
2 Static moment 	$M_2 = m \times g \times Z$ $= 5.5 \times 9.8 \times 100/1000$ $= 5.4$ [N·m] $\alpha_2 = M_2/M_{2max}$ $= 5.4/28.0$ $= 0.19$	Examine M_2 . M_1, M_3 values do not apply to this example. Refer to [3] Calculation for Overall Center of Gravity in the Z-axis on front matter 7. Find the value M_{2max} when $V_a = 250$ mm/s from Graph (13) [3].
3 Dynamic moment  	$FE = 1.4 \times V_a \times m \times g \times \delta$ $= 1.4 \times 250 \times 5.5 \times 9.8 \times 1/100$ $= 188.7$ [N] $M_{1E} = 1/3 \times FE \times Z$ $= 1/3 \times 188.7 \times 100/1000$ $= 6.3$ [N·m] $\alpha_{3A} = M_{1E}/M_{1max}$ $= 6.3/17.1$ $= 0.37$	Calculate for the impact load. Since the impact is absorbed by shock absorber, the bumper coefficient $\delta = 1/100$ Examine M_{1E} . Calculate the collision speed V. $V = 1.4 \times V_a$ $V = 1.4 \times 250$ $V = 350$ mm/s Find the value M_{1Emax} when $V_a = 350$ mm/s from Graph (11) [4].
4 Judgement	$\Sigma\alpha_n = \alpha_1 + \alpha_2 + \alpha_{3A} + \alpha_{3B}$ $= 0.07 + 0.19 + 0.37 + 0.09$ $= 0.72$	Examine M_{3E} . Refer to [3] Calculation for Overall Center of Gravity in the Y-axis on front matter 7. From the results above, Find the value M_{3Emax} when $V_a = 350$ mm/s from Graph (11) [5]. $\Sigma\alpha_n = 0.72 \leq 1$, so the cylinder can be used.

[Graph 5] Allowable load mass by stroke ø25

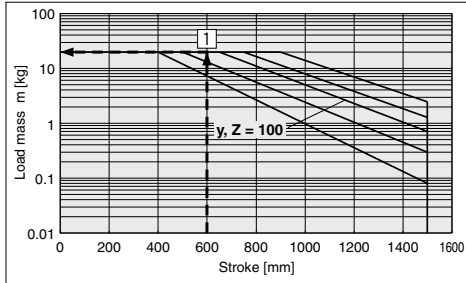

[Graph 9] Allowable load mass on guides m

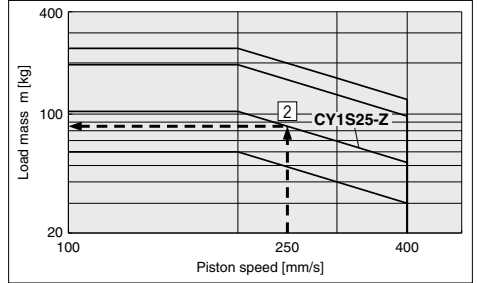

[Graph 13] Allowable moment M2

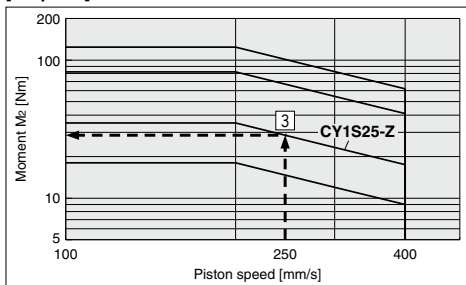

[Graph 11] Allowable moment M1, M3

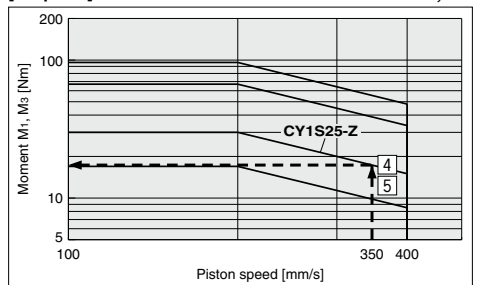

Calculation of Guide Load Factor

Calculation example 2 Vertical mounting

[1] Operating Conditions

Cylinder: **CY1SG20-700**
 Cushion: Shock absorber
 Mounting: Vertical mounting
 Speed: $V_a = 200$ [mm/s]

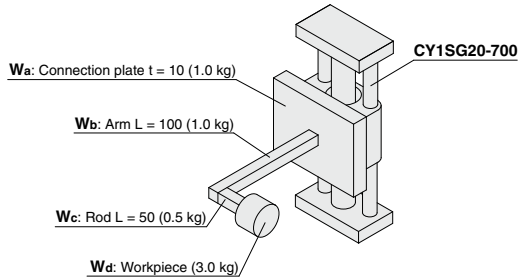

[2] Load Blocking

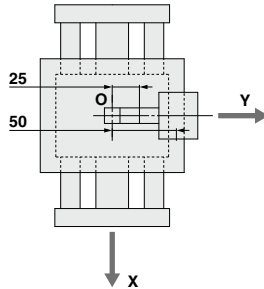
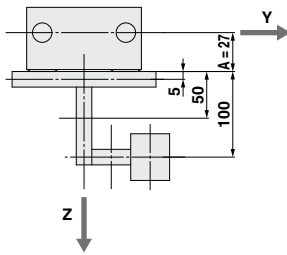

Mass and center of gravity of the load

Load no. W_n	Mass m_n	Center of gravity		
		X-axis x_n	Y-axis y_n	Z-axis z_n
Wa	1.0 kg	0 mm	0 mm	5 mm
Wb	1.0 kg	0 mm	0 mm	50 mm
Wc	0.5 kg	0 mm	25 mm	100 mm
Wd	3.0 kg	0 mm	50 mm	100 mm

$n = a, b, c, d$

[3] Calculation for Overall Center of Gravity

$$m_t = \sum m_n$$

$$= 1.0 + 1.0 + 0.5 + 3.0$$

$$= 5.5 \text{ kg}$$

$$X = 0 \text{ mm}$$

(The center of gravity in the x direction of all work pieces is 0, so $X = 0$ mm.)

$$Y = \frac{1}{m_t} \times \sum (m_n \times y_n)$$

$$= \frac{1}{5.5} \times (1.0 \times 0 + 1.0 \times 0 + 0.5 \times 25 + 3.0 \times 50)$$

$$= 30 \text{ mm}$$

$$Z = \frac{1}{m_t} \times \sum (m_n \times (A + z_n))$$

$$= \frac{1}{5.5} \times (1.0 \times (27 + 5) + 1.0 \times (27 + 50) + 0.5 \times (27 + 100) + 3.0 \times (27 + 100))$$

$$= 101 \text{ mm}$$

[4] Check the allowable load.

Item	Result	Note
(1) Check allowable load mass by thrust.	Work load is 5.5 kg < 11 kg. OK	Check the allowable load for vertical mounting. The bore size is $\phi 20$, so the maximum load for vertical mounting will be 11 kg.
(2) Allowable load by stroke	No restriction	The cylinder is mounted in the vertical direction, and the load generates no rolling moment, so there is no restriction.

[5] Judgement of Guide Load Factor

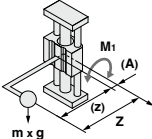
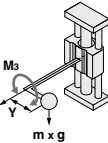
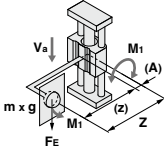
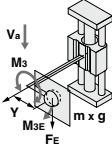
Item	Load factor αn	Note
1 Load mass	$\alpha_1 = 0$	In case of vertical mounting, no static load is applied.
2 Static moment  	$M_1 = m \times g \times Z$ $= 5.5 \times 9.8 \times 101/1000$ $= 5.4 \text{ [N}\cdot\text{m]}$ $\alpha_{2A} = M_1/M_{1\text{max}}$ $= 5.4/17.0$ $= 0.32$	Examine M_1 . Refer to [3] Calculation for Overall Center of Gravity in the Z-axis on front matter 7. Find the value of $M_{1\text{max}}$ when $V_a = 200 \text{ mm/s}$ from Graph (11) [1] .
	$M_3 = m \times g \times Y$ $= 5.5 \times 9.8 \times 30/1000$ $= 1.6 \text{ [N}\cdot\text{m]}$ $\alpha_{2B} = M_3/M_{3\text{max}}$ $= 1.6/17.0$ $= 0.10$	Examine M_3 . Refer to [3] Calculation for Overall Center of Gravity in the Y-axis on front matter 7. Find the value of $M_{3\text{max}}$ when $V_a = 200 \text{ mm/s}$ from Graph (11) [2] . M_2 value does not apply to this example.
3 Dynamic moment  	$F_E = 1.4 \times V_a \times m \times g \times \delta$ $= 1.4 \times 200 \times 5.5 \times 9.8 \times 1/100$ $= 150.9 \text{ [N]}$ $M_{1E} = 1/3 \times F_E \times Z$ $= 1/3 \times 150.9 \times 101/1000$ $= 5.1 \text{ [N}\cdot\text{m]}$ $\alpha_{3A} = M_{1E}/M_{1\text{max}}$ $= 5.1/12.1$ $= 0.42$	Calculate the impact load. Since the impact is absorbed by shock absorber, the bumper coefficient $\delta = 1/100$ Examine M_{1E} . Calculate the collision speed V . $V = 1.4 \times V_a$ $V = 1.4 \times 200$ $V = 280 \text{ mm/s}$ Find the value of $M_{1E\text{max}}$ when $V_a = 280 \text{ mm/s}$ from Graph (11) [3] .
	$M_{3E} = 1/3 \times F_E \times Y$ $= 1/3 \times 150.9 \times 30/1000$ $= 1.5 \text{ [N}\cdot\text{m]}$ $\alpha_{3B} = M_{3E}/M_{3\text{max}}$ $= 1.5/12.1$ $= 0.12$	Examine M_{3E} . From the results above, Find the value of $M_{3E\text{max}}$ when $V_a = 280 \text{ mm/s}$ from Graph (11) [4] .
4 Judgement	$\Sigma\alpha_n = \alpha_1 + \alpha_{2A} + \alpha_{2B} + \alpha_{3A} + \alpha_{3B}$ $= 0 + 0.32 + 0.10 + 0.42 + 0.12$ $= 0.96$	$\Sigma\alpha_n = 0.96 \leq 1$, so the cylinder can be used.

[Graph 11] Allowable moment

M1, M3

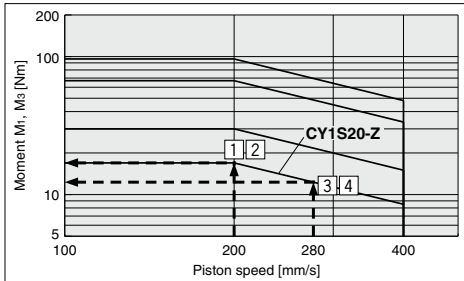

Load factors on the guides can be calculated with the SMC Pneumatic CAD system.

Caution on Design

Vertical Operation

When operating a load vertically, it should be operated within the allowable load mass and allowable pressure as shown in the table below.

Operating the cylinder above the specified values may lead to the load dropping. If accurate stopping position is required, consider using a metal-ended external stopper.

Bore size (mm)	Allowable load mass (mv) (kg)	Allowable pressure (Pv) (MPa)
6	1.0	0.55
10	2.7	
15	7.0	0.65
20	11.0	
25	18.5	
32	30.0	
40	47.0	

Note 1) Use caution, as operating the cylinder above the allowable pressure may lead to the magnetic coupling separating and allowing the load to fall.

Note 2) The allowable load mass above indicates the allowable load mass in the vertical operation. The actual load mass must be determined by referring to the model selection flow chart on front matter 1.

Note 3) As a guide, the load mass should be approximately 60% of the thrust load factor.

Intermediate Stop

1. When an intermediate stop is performed with an external stopper etc.

When stopping a load in mid-stroke using an external stopper, adjustment bolt or bumper bolt, operate within operating pressure limits shown in the table below. Use caution, as operating the cylinder above these pressures may lead to the breaking of the magnetic coupling.

(The piston speed should be the allowable value or less.)

Bore size (mm)	Allowable pressure for the intermediate stop with an external stopper (Ps) (MPa)
6	0.55
10	
15	0.65
20	
25	
32	
40	

Note 1) Exceeding the allowable pressure will lead to the breaking of the magnetic coupling and cause the piston slider and external slider becoming separated.

Note 2) Fine stroke adjustment for the external slider is also considered as an intermediate stop, so pay attention to the operating pressure.

2. When an intermediate stop is performed with the pneumatic circuit.

When an intermediate stop is performed with the pneumatic circuit with 3-position solenoid valve, the kinetic energy should be as stated or less than the values in the table below.

(The piston speed should be the allowable value or less.)

Bore size (mm)	Allowable kinetic energy for the intermediate stop with the pneumatic circuit (Es) (J)
6	0.007
10	0.03
15	0.13
20	0.24
25	0.45
32	0.88
40	1.53

Note 1) Exceeding the allowable kinetic energy will lead to the breaking of the magnetic coupling and cause the piston slider and external slider becoming separated.

Magnetically Coupled Rodless Cylinder

Slider Type: Slide Bearing

CY1S Series

ø6, ø10, ø15, ø20, ø25, ø32, ø40



How to Order

Slide bearing **CY1S** **25** - **300** **Z** - **M9BW** -

Slider type
(Slide bearing type)

Piping

NII	Bilateral piping type	
G	Centralized piping type	

Note) For centralized piping, the port will be placed on the plate A side.

Bore size

6	6 mm
10	10 mm
15	15 mm
20	20 mm
25	25 mm
32	32 mm
40	40 mm

Port thread type

Symbol	Type	Bore size (mm)
NII	M thread	6, 10, 15
	Rc	
TN	NPT	20, 25, 32, 40
TF	G	

Standard stroke
Refer to page 1215 for the standard strokes.

Made to Order
Refer to page 1215 for details.

Number of auto switches

NII	2 pcs.
S	1 pc.
n	"n" pcs.

Auto switch

NII	Without auto switch
-----	---------------------

* Refer to the table below for the applicable auto switch model.
Note) Auto switch rail and magnet for auto switch included as standard.

Stopper type

NII	Bumper bolt (resin tipped): Mounted on both sides	
		Bumper bolt (Same as the opposite side)
B	Shock absorber/ Adjustment bolt (metal ended): Mounted on both sides	
		Adjustment bolt (Same as the opposite side)
		Shock absorber (Same as the opposite side)
BS	Shock absorber/ Adjustment bolt (metal ended): Plate A side	
	Bumper bolt (resin tipped): Plate B side or C side	
		Bumper bolt Adjustment bolt Shock absorber

Applicable Auto Switches

Refer to pages 1289 to 1383 for further information on auto switches.

Type	Special function	Electrical entry	Indicator light	Wiring (Output)	Load voltage		Auto switch model		Lead wire length (m)				Pre-wired connector	Applicable load	
					DC	AC	Perpendicular	In-line	0.5	1	3	5			
									(NII)	(M)	(L)	(Z)			
Solid state auto switch	—	Grommet	Yes	3-wire (NPN)	5 V, 12 V	—	M9NV	M9N	●	●	○	○	IC circuit	Relay, PLC	
				3-wire (PNP)			12 V	M9PV	M9P	●	●	○			○
				2-wire	5 V, 12 V	M9BV	M9B	●	●	○	○	—			
				3-wire (NPN)		12 V	M9NVW	M9NW	●	●	○	○			IC circuit
	Diagnostic indication (2-color indicator)	Grommet	Yes	3-wire (PNP)	5 V, 12 V	—	M9PVW	M9PW	●	●	○	○	—		
				2-wire			12 V	M9BVW	M9BW	●	●	○	○		—
	Water resistant (2-color indicator)	Grommet	Yes	3-wire (NPN)	5 V, 12 V	—	M9NAV ^{*1}	M9NA ^{*1}	○	○	○	○	IC circuit		
				3-wire (PNP)			12 V	M9PAV ^{*1}	M9PA ^{*1}	○	○	○	○		—
	2-wire	Grommet	No	3-wire (NPN equivalent)	24 V	12 V	A96V	A96	●	—	●	—	—		IC circuit
				2-wire			100 V	A93V ^{*2}	A93	●	●	●	●		—
				100 V or less		A90V	A90	●	—	●	—	—	IC circuit		

*1 Water resistant type auto switches can be mounted on the above models, but in such case SMC cannot guarantee water resistance. Please consult with SMC regarding water resistant types with the above model numbers.

*2 1 m type lead wire is only applicable to D-A93.

* Lead wire length symbols: 0.5 m NII (Example) M9NW
1 m M (Example) M9NWM
3 m L (Example) M9NWL
5 m Z (Example) M9NWX

* Solid state auto switches marked with "○" are produced upon receipt of order.

* There are other applicable auto switches other than listed above. For details, refer to page 1220.

* For details about auto switches with pre-wired connector, refer to pages 1358 and 1359.

* Auto switches are shipped together, (but not assembled).



Magnetically Coupled Rodless Cylinder Slider Type: Slide Bearing **CY1S Series**

Specifications



Symbol

Rubber bumper
(Magnet type)

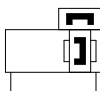

Made to Order: Individual Specifications
(For details, refer to pages 1221 and 1222.)

Symbol	Specifications
-X116	Air-hydro
-X168	Helical insert thread
-X210	Non-lubricated exterior (without dust seal)
-X322	Outside of cylinder tube with hard chrome plated
-X324	Non-lubricated exterior (with dust seal)
-X431	Switch rails on both sides (with 2 pcs.)
-X2423	Mounting surface tapped hole type

Made to Order

[Click here for details](#)

Symbol	Specifications
-XB9	Low speed (15 to 50 mm/s)
-XB13	Ultra low speed (7 to 50 mm/s)

Bore size (mm)	6	10	15	20	25	32	40
Fluid	Air						
Proof pressure	1.05 MPa						
Maximum operating pressure	0.7 MPa						
Minimum operating pressure	0.18 MPa						
Ambient and fluid temperature	-10 to 60°C (No freezing)						
Piston speed*	50 to 400 mm/s						
Cushion	Rubber bumper/Shock absorber						
Lubrication	Non-lube						
Stroke length tolerance (mm)	0 to 250 st: $^{+1.0}_0$, 251 to 1000 st: $^{+1.4}_0$, 1001st or longer: $^{+1.8}_0$						
Magnetic holding force (N)	19.6	53.9	137	231	363	588	922

* In the case of setting an auto switch at the intermediate position, the maximum piston speed is subject to restrict for detection upon the response time of a load (relays, sequence controller, etc.).

Standard Strokes

Bore size (mm)	Standard stroke (mm)	Maximum manufacturable stroke (mm)
6	50, 100, 150, 200	300
10	50, 100, 150, 200, 250, 300	500
15	50, 100, 150, 200, 250, 300, 350, 400, 450, 500	750
20	100, 150, 200, 250, 300, 350, 400, 450,	1000
25	500, 600, 700, 800	1500
32		
40	100, 150, 200, 250, 300, 350, 400, 450, 500, 600, 700, 800, 900, 1000	1500

Note 1) Intermediate stroke is available in 1 mm increments. (Produced upon receipt of order)

Note 2) Minimum stroke available without auto switch or with one auto switch is 15 mm and minimum 25 mm for with 2 auto switches.

Note 3) For 2 or more auto switches with stroke less than 25 mm (minimum 15 mm), consider "X431" (2 switch rails).

Weights

CY1S□	Bore size (mm)	Bore size (mm)							(kg)
		6	10	15	20	25	32	40	
CY1S□	Basic weight	0.231	0.428	0.743	1.317	1.641	2.870	4.508	
	Additional weight for 50 stroke	0.053	0.082	0.111	0.184	0.186	0.284	0.430	
CY1SG□	Basic weight	0.236	0.435	0.743	1.331	1.662	2.903	4.534	
	Additional weight for 50 stroke	0.050	0.079	0.108	0.176	0.178	0.273	0.411	

Calculation: (Example) CY1SG25-500Z

Basic weight (At 0 stroke) ... 1.662 kg Additional weight for 50 stroke ... 0.178 kg

Cylinder stroke ... 500 st

$1.662 + 0.178 \times 500 \div 50 = 3.442$ kg

Shock Absorber Specifications

Applicable cylinder	CY1S□6	CY1S□10	CY1S□15	CY1S□20	CY1S□25	CY1S□32	CY1S□40
Shock absorber model	RJ0604	RJ0806H	RJ0806L	RJ1007L	RJ1412L	RJ2015H	RJ2015L
Max. absorbed energy (J)	0.5	1	3	10	30		
Stroke absorption (mm)	4	6	7	12	15		
Collision speed (m/s)	0.05 to 1	0.05 to 2	0.05 to 1	0.05 to 1	0.05 to 1	0.05 to 2	0.05 to 1
Max. operating frequency (cycle/min)	80	80	70	45	25		
Max. allowable thrust (N)	150	245	422	814	1961		
Ambient temperature (°C)	-10 to 60°C (No freezing)						

Note) The maximum absorbed energy and maximum operating frequency was measured at ordinary temperature (approximately 20 to 25°C.)

CY1S Series

Construction

CY1S/Bilateral piping type

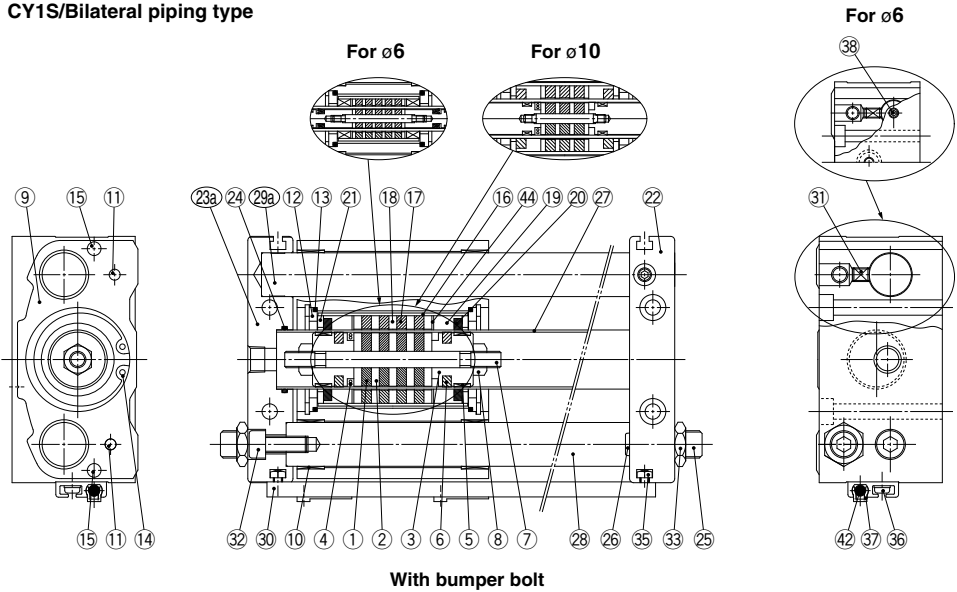

CY1SG/Centralized piping type

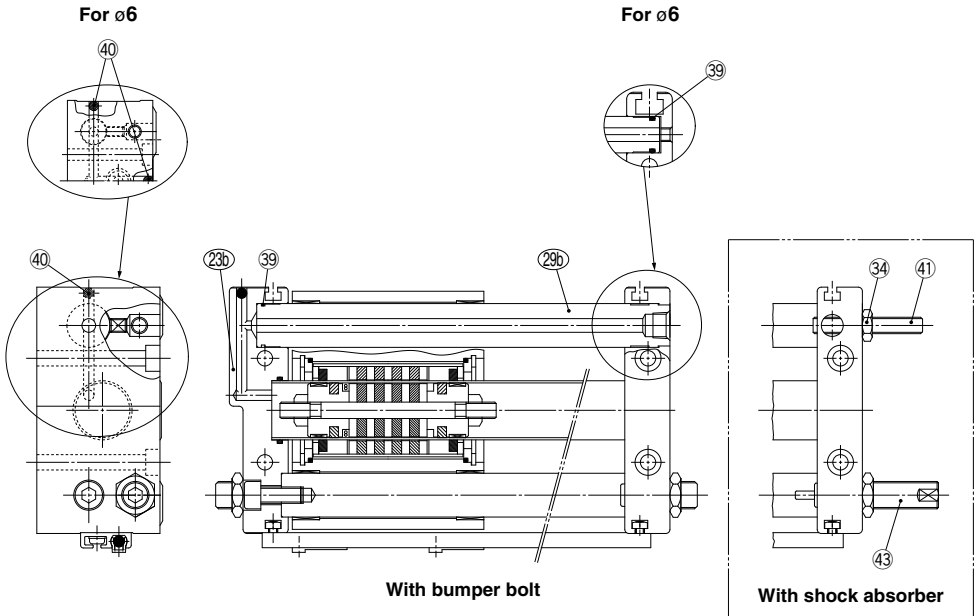

Component Parts

No.	Description	Material	Note
1	Magnet A	—	
2	Piston side yoke	Rolled steel	
3	Piston	Aluminum alloy	
4*	Piston seal	NBR	
5*	Wear ring A	Special resin	
6*	Lube-retainer A	Special resin	Except ø6, ø10
7	Shaft	Stainless steel	
8	Piston nut	Carbon steel	Except ø6 to ø15
9	Slide block	Aluminum alloy	
10	Bushing	Bearing alloy	
11	Parallel pin	Carbon steel	
12	Slider spacer	Rolled steel	
13*	Slider gasket	NBR	
14	Retaining ring	Carbon tool steel	
15	Magnet for switch	—	
16	External slider tube	Aluminum alloy	
17	Magnet B	—	
18	External slider side yoke	Rolled steel	
19*	Wear ring B	Special resin	
20*	Lube-retainer B	Special resin	Except ø6
21	Spacer	Rolled steel	Except ø6
22	Plate A	Aluminum alloy	
23a	Plate C	Aluminum alloy	Bilateral piping
23b	Plate B	Aluminum alloy	Centralized piping

No.	Description	Material	Note
24*	Cylinder tube gasket	NBR	
25	Bumper bolt	Chromium molybdenum steel	
26	Bumper	Urethane rubber	
27	Cylinder tube	Stainless steel	
28	Guide shaft B	Carbon steel	Hard chrome plated
29a	Guide shaft C	Carbon steel	Hard chrome plated
29b	Guide shaft A	Carbon steel	Hard chrome plated
30	Switch rail	Aluminum alloy	
31	Hexagon socket head set screw	Chromium molybdenum steel	
32	Hexagon socket head cap screw	Chromium molybdenum steel	
33	Hexagon nut	Chromium molybdenum steel	
34	Hexagon nut	Chromium molybdenum steel	
35	Square nut	Chromium molybdenum steel	
36	Cross-recessed head machine screw with SW	Chromium molybdenum steel	
37	Switch spacer	Special resin	
38	Port plug	Chromium molybdenum steel	ø6. Bilateral piping only
39*	Guide shaft gasket	NBR	Centralized piping
40	Steel ball	Bearing steel	Centralized piping
41	Adjustment bolt	Chromium molybdenum steel	
42	Auto switch	—	
43	Shock absorber	—	
44	Liner	Aluminum alloy	

Note 1) * denotes parts that are included in the seal kit.

Note 2) Auto switch and switch spacer are shipped together with the product, but not assembled.

Seal Kit

Bore size (mm)	Seal kit	
	Kit no.	Contents
6	CY1S6-Z-PS	Set of the nos. 4, 5, 13, 19, 24, 39
10	CY1S10-Z-PS	Set of the nos. 4, 13, 19, 20, 24, 39
15	CY1S15-Z-PS	Set of the nos. 4, 5, 6, 13, 19, 20, 24, 39
20	CY1S20-Z-PS	
25	CY1S25-Z-PS	
32	CY1S32-Z-PS	
40	CY1S40-Z-PS	

Note 1) Seal kit includes 4, 5, 13, 19, 24, 39 for ø6, 4, 13, 19, 20, 24, 39 for ø10, 4, 5, 6, 13, 19, 20, 24, 39 are for ø15 to ø40.

Order the seal kit, based on each bore size.

Note 2) Seal kit includes a grease pack (10 g).

Order with the following part number when only the grease pack is needed.

Grease pack part number: GR-S-010

Replacement Parts

Bore size (mm)	Bumper bolt assembly		Adjustment bolt assembly		Switch spacer	
	Kit no.	Contents	Kit no.	Contents	Kit no.	Contents
6	CYS06-37-AJ024-R	Set of the nos. 25, 26, 33	CYS06-37AAJ024-R	Set of the nos. 34, 41	BMY3-016	Set of the nos. 37
10	CYS10-37-AJ025-R		CYS10-37AAJ025-R			
15	CYS15-37-AJ026-R		CYS15-37AAJ026-R			
20	CYS20-37-AJ027-R		CYS20-37AAJ027-R			
25	CYS25-37-AJ028-R		CYS25-37AAJ028-R			
32	CYS32-37-AJ029-R		CYS32-37AAJ029-R			
40	CYS40-37-AJ030-R					

Note 3) A switch spacer, as specified in the table above will be required if an auto switch is mounted afterward.

When ordering an additional auto switch, also order an additional switch spacer.

(Refer to "Auto Switch Mounting" on page 1220 for details.)

CY1S Series

Dimensions

CY1S/Bilateral piping type

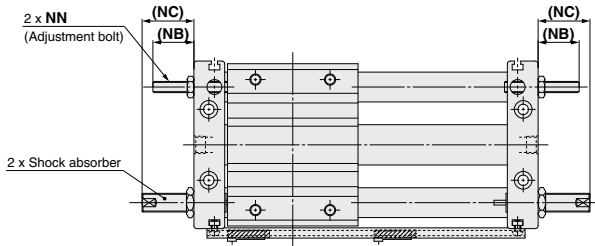
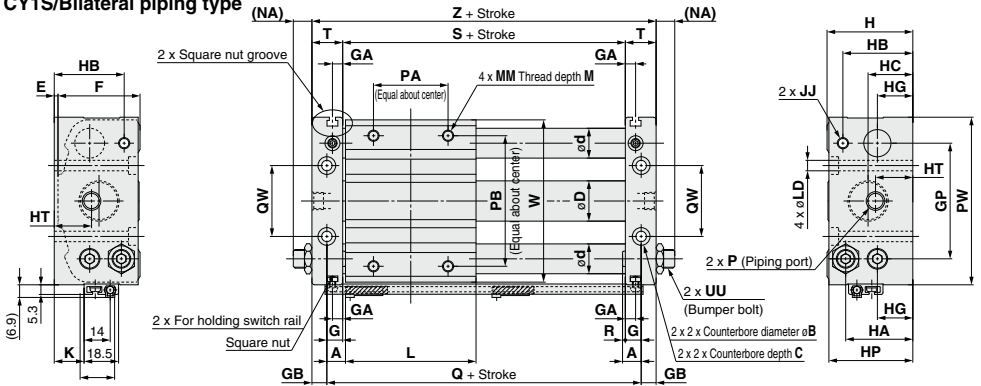

Amount of stroke adjustment

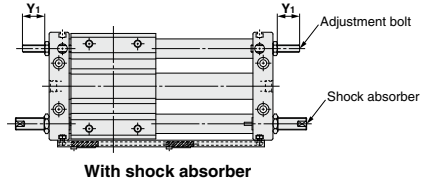
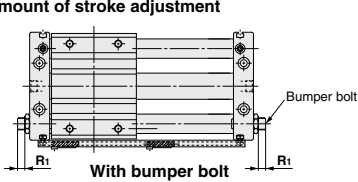

Dimensions

Model	A	B	C	D	d	E	F	G	GA	GB	GP	H	HA	HB	HC	HG	HP	HT	JJ	K	L	LD	M	MM	NA	NB	NC
CY1S6-Z	6	6.5	3.3	7.6	8	2	25	5	5	5	30	27	20.5	20.5	15.5	8	26	15.5	M4 x 0.7	3	40	3.5	6	M4 x 0.7	11	14	19
CY1S10-Z	7.5	8	4.4	12	10	2.5	31.5	6.5	5	6	40	34	25	27	17	13.5	33	17	M4 x 0.7	6	45	4.6	6	M4 x 0.7	10.5	16.5	28
CY1S15-Z	7.5	9.5	5.4	16.6	12	2	38	6.5	5	6	52	40	28	29.5	20.5	15	39	20.5	M4 x 0.7	11	60	5.8	8	M5 x 0.8	10.5	16.5	28
CY1S20-Z	10	9.5	5.4	21.6	16	2	44	8.5	5.5	8	62	46	36	37.5	24	19	45	20	M6 x 1	16	70	5.8	10	M6 x 1	10.5	22	28
CY1S25-Z	10	11	6.5	26.4	16	2	52	8.5	5.5	8	70	54	40.5	40.5	27.5	21.5	53	21	M6 x 1	20	70	7	10	M6 x 1	12.5	22	49
CY1S32-Z	12.5	14	8.6	33.6	20	2	64	9.5	5.5	9	86	66	50	50	33	26	64	24	M8 x 1.25	26	85	9	12	M8 x 1.25	11.5	23.5	52
CY1S40-Z	12.5	14	8.6	41.6	25	2	74	10.5	5.5	10	104	76	55.5	55.5	38	27	74	27	M8 x 1.25	28	95	9	12	M8 x 1.25	10.5	22.5	51

Model	NN	P			PA	PB	PW	Q	QW	R	R1	S	T	UU	W	Y1	Z	Shock absorber		
		Nil	TN	TF																
CY1S6-Z	M4 x 0.7	M3x0.5	—	—	25	25	49	52	16	1	7.5	15	42	10	M6 x 0.75	46	11.5	23	62	RJ0604N
CY1S10-Z	M4 x 0.7	M5x0.8	—	—	25	38	61	60	24	1	5.5	11	47	12.5	M8 x 1	58	14	28	72	RJ0806HN
CY1S15-Z	M4 x 0.7	M5x0.8	—	—	30	50	76	75	30	1	5.5	11	62	12.5	M8 x 1	73	14	28	87	RJ0806LN
CY1S20-Z	M6 x 1	Rc1/8	NPT1/8	G1/8	40	70	90	90	38	1.5	4.5	9	73	16.5	M10 x 1	87	18.5	37	106	RJ1007LN
CY1S25-Z	M6 x 1	Rc1/8	NPT1/8	G1/8	40	70	99	90	42	1.5	4.5	9	73	16.5	M14 x 1.5	96	18.5	37	106	RJ1412LN
CY1S32-Z	M8 x 1.25	Rc1/8	NPT1/8	G1/8	40	75	119	110	50	3	5.5	11	91	18.5	M20 x 1.5	116	18.5	37	128	RJ2015HN
CY1S40-Z	M8 x 1.25	Rc1/4	NPT1/4	G1/4	65	105	142	120	64	2	4.5	9	99	20.5	M20 x 1.5	139	17.5	35	140	RJ2015LN

Note) The above figures show the product with auto switches. Auto switch and switch spacer are shipped together with the product, but not assembled.

Magnetically Coupled Rodless Cylinder Slider Type: Slide Bearing **CY1S Series**

Dimensions

CY1SG/Centralized piping type

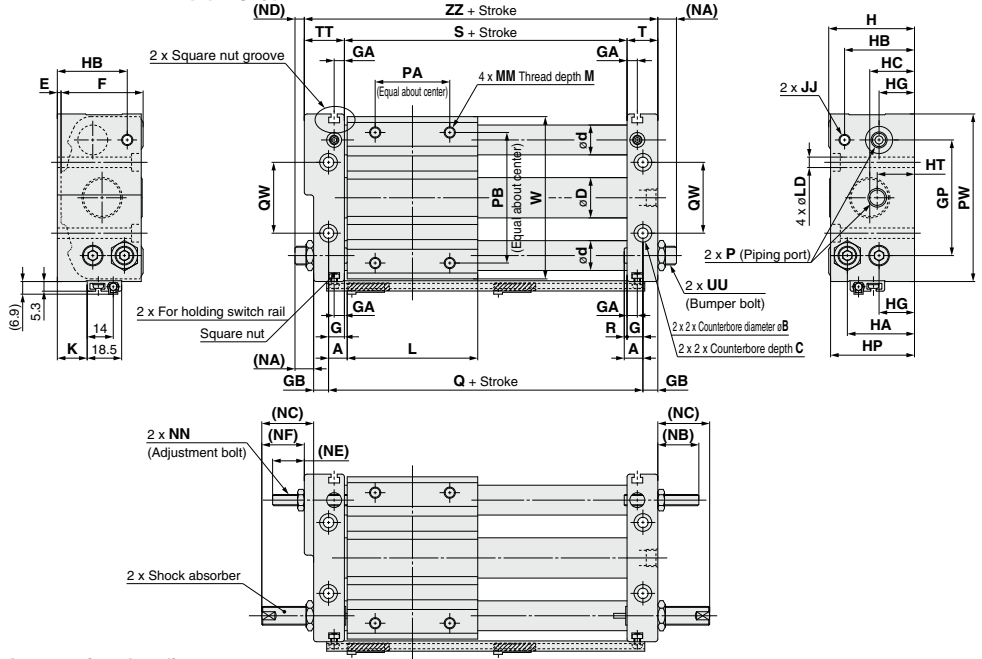

Amount of stroke adjustment

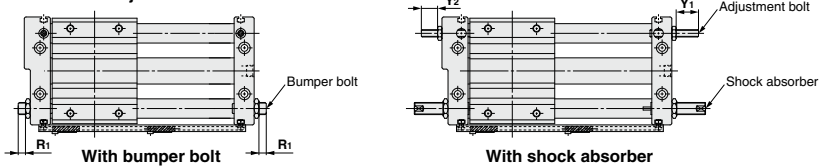

Dimensions

Model	A	B	C	D	d	E	F	G	GA	GB	GP	H	HA	HB	HC	HG	HP	HT	JJ	K	L	LD	M	MM	NA	NB	NC	ND	NE
CY1SG6-Z	6	6.5	3.3	7.6	8	2	25	5	5	5	30	27	20.5	20.5	15.5	8	26	15.5	M4 x 0.7	3	40	3.5	6	M4 x 0.7	11	14	19	7	10
CY1SG10-Z	7.5	8	4.4	12	10	2.5	31.5	6.5	5	6	40	34	25	27	17	13.5	33	17	M4 x 0.7	6	45	4.6	6	M4 x 0.7	10.5	16.5	28	6.5	12.5
CY1SG15-Z	7.5	9.5	5.4	16.6	12	2	38	6.5	5	6	52	40	28	29.5	20.5	15	39	20.5	M4 x 0.7	11	60	5.8	8	M5 x 0.8	10.5	16.5	28	5.5	11.5
CY1SG20-Z	10	9.5	5.4	21.6	16	2	44	8.5	5.5	8	62	46	36	37.5	24	19	45	20	M6 x 1	16	70	5.8	10	M6 x 1	10.5	22	28	5.5	17
CY1SG25-Z	10	11	6.5	26.4	16	2	52	8.5	5.5	8	70	54	40.5	40.5	27.5	21.5	53	21	M6 x 1	20	70	7	10	M6 x 1	12.5	22	49	7.5	17
CY1SG32-Z	12.5	14	8.6	33.6	20	2	64	9.5	5.5	9	86	66	50	50	33	26	64	24	M8 x 1.25	26	85	9	12	M8 x 1.25	11.5	23.5	52	5.5	17.5
CY1SG40-Z	12.5	14	8.6	41.6	25	2	74	10.5	5.5	10	104	76	55.5	55.5	38	27	74	27	M8 x 1.25	28	95	9	12	M8 x 1.25	10.5	22.5	51	4.5	16.5

Model	NF	NN	P			PA	PB	PW	Q	QW	R	R1	S	T	TT	UU	W	Y1	Y2	ZZ	Shock absorber		
			NI	TN	TF																		
CY1SG6-Z	15	M4 x 0.7	M3 x 0.5	—	—	25	25	49	52	16	1	7.5	15	42	10	14	M6 x 0.75	46	11.5	7.5	19	66	RJ0604N
CY1SG10-Z	23	M4 x 0.7	M5 x 0.8	—	—	25	38	61	60	24	1	5.5	11	47	12.5	16.5	M8 x 1	58	14	10	24	76	RJ0806HN
CY1SG15-Z	24	M4 x 0.7	M5 x 0.8	—	—	30	50	76	75	30	1	5.5	11	62	12.5	17.5	M8 x 1	73	14	9	23	92	RJ0806LN
CY1SG20-Z	23	M6 x 1	Rc1/8	NPT1/8	G1/8	40	70	90	90	38	1.5	4.5	9	73	16.5	21.5	M10 x 1	87	18.5	13.5	32	111	RJ1007LN
CY1SG25-Z	44	M6 x 1	Rc1/8	NPT1/8	G1/8	40	70	99	90	42	1.5	4.5	9	73	16.5	21.5	M14 x 1.5	96	18.5	13.5	32	111	RJ1412LN
CY1SG32-Z	46	M8 x 1.25	Rc1/8	NPT1/8	G1/8	40	75	119	110	50	3	5.5	11	91	18.5	24.5	M20 x 1.5	116	18.5	12.5	31	134	RJ2015HN
CY1SG40-Z	45	M8 x 1.25	Rc1/4	NPT1/4	G1/4	65	105	142	120	64	2	4.5	9	99	20.5	26.5	M20 x 1.5	139	17.5	11.5	29	146	RJ2015LN

Note) The above figures show the product with auto switches. Auto switch and switch spacer are shipped together with the product, but not assembled.

CY1S Series Auto Switch Mounting

Auto Switch Proper Mounting Position (Detection at stroke end)

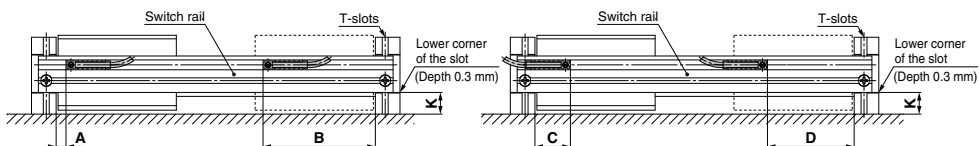

- Note 1) The minimum stroke when 2 in-line auto switches are mounted as shown above is 50 mm.
The minimum stroke when the mounting screws of the auto switches face each other is 25 mm.
- Note 2) The minimum stroke when no auto switch is mounted is 15 mm.

Auto Switch Proper Mounting Position

Auto switch model		(mm)							
Bore size	K dimension (Switch rail height)	A		B		C		D	
		D-M9□ D-M9□V D-M9□W D-M9□WV D-M9□A D-M9□AV	D-A9□ D-A9□V	D-M9□ D-M9□V D-M9□W D-M9□WV D-M9□A D-M9□AV	D-A9□ D-A9□V	D-M9□ D-M9□V D-M9□W D-M9□WV D-M9□A D-M9□AV	D-A9□ D-A9□V	D-M9□ D-M9□V D-M9□W D-M9□WV D-M9□A D-M9□AV	D-A9□ D-A9□V
6	3	5.5	1.5	36.5	40.5	17.5	21.5	24.5	20.5
10	6	5.5	1.5	41.5	45.5	17.5	21.5	29.5	25.5
15	11	5.5	1.5	56.5	60.5	17.5	21.5	44.5	40.5
20	16	6	2	67	71	18	22	55	51
25	20	6	2	67	71	18	22	55	51
32	26	7.5	3.5	83.5	87.5	19.5	23.5	71.5	67.5
40	28	6.5	2.5	92.5	96.5	18.5	22.5	80.5	76.5

- Note 1) The values in the above list are used as a guide for the auto switch mounting position for end of stroke detection.
Adjust the auto switch after confirming the operating conditions in the actual setting.
- Note 2) If the switch rail is reassembled or mounted on the other side of the cylinder, maintain the K dimension (switch rail height: lower corner of the slot) in the table above.
The switch rail is secured by screwing the cross-recessed round head screw into a square nut in the T-slots of the end plates. Care must be taken when removing the switch rail so that the screws or nuts are not lost.

Operating Range

Auto switch model	Bore size (mm)						
	6	10	15	20	25	32	40
D-M9□ D-M9□V D-M9□W D-M9□WV D-M9□A D-M9□AV	3	3	2.5	2.5	3	2.5	3
D-A9□ D-A9□V	5.5	5.5	5.5	5.5	5.5	5.5	6

- Note) Values which include hysteresis are for guideline purposes only, they are not a guarantee (assuming approximately ±30% dispersion) and may change substantially depending on the ambient environment.

Auto Switch Mounting Bracket (Switch spacer)

Auto switch model	Bore size (mm)	
	6 to 40	
D-M9□ D-M9□V D-M9□W D-M9□WV D-M9□A D-M9□AV	BMY3-016	
D-A9□ D-A9□V		

- Note) The part number above is the order number for the switch spacer.

Auto Switch Mounting

As shown in the figure to the right, combine the auto switch with the switch spacer (BMY3-016) to secure the auto switch in the mounting groove of the switch rail. Combine the auto switch with the switch spacer and secure into position by tightening the auto switch mounting screw with a flat blade watchmakers' screwdriver.

- Note) When tightening the auto switch mounting screw, use watchmakers' screwdriver with a handle diameter of 5 to 6 mm.
Set the tightening torque to 0.1 to 0.15 N·m.

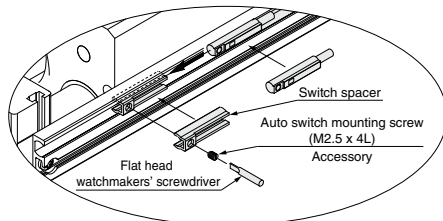

Other than the applicable auto switches listed in "How to Order", the following auto switches are mountable.

- * Normally closed (NC = b contact) solid state auto switches (D-M9□(V)) are also available. For details, refer to page 1308.
- * With pre-wired connector is also available for solid state auto switches. For details, refer to pages 1358 and 1359.



Made-to-Order List

Bore size (mm)	Air-hydro	Helical insert thread	Non-lubricated exterior (without dust seal)	Outside of cylinder tube with hard chrome plated	Non-lubricated exterior (with dust seal)	Auto switch rails on both sides	Mounting surface tapped hole type
	-X116	-X168	-X210	-X322	-X324	-X431	-X2423
6			●			●	●
10			●		●	●	●
15			●	●	●	●	●
20		●	●		●	●	●
25	●	●	●	●	●	●	●
32	●	●	●	●	●	●	●
40	●	●	●	●	●	●	●

Note) ● indicates "applicable" and blank indicates "not applicable".

1 Air-hydro Symbol -X116

Air-hydro type is suitable for precise low speed feeding, intermediate stop and skip feeding.

Standard model no. - X116

● Air-hydro

Specifications

Bore size (mm)	25	32	40
Orifice diameter (mm)	8	8	11
Fluid	Turbine oil class 1 (ISO VG32)		
Piston speed (mm/s)	15 to 300		
Dimensions	The same dimensions as the bilateral piping type		

Note 1) This product is only applicable to the bilateral piping type.

Note 2) When an intermediate stop is performed in the air-hydro circuit, the kinetic energy of the load should be the allowable value or less.

(Refer to "When an intermediate stop is performed with the pneumatic circuit" for the allowable values.)

Note 3) Do not use machine oil or spindle oil.

2 Helical Insert Thread Symbol -X168

Change mounting thread on the external slider to helical insert thread.

Standard model no. - X168

● Helical insert thread

Dimensions: Same as standard type

3 Non-lubricated Exterior (Without dust seal) Symbol -X210

Suitable for environments where oil is not tolerated.

It is recommended to use this type in a special environment where standard product causes lubrication failure.

Standard model no. - X210

● Non-lubricated exterior (without dust seal)

Dimensions: Same as standard type

Note) Consider installing a protective cover if the product is used in an environment where foreign matter such as paper powder might be caught in the sliding parts of the cylinder.

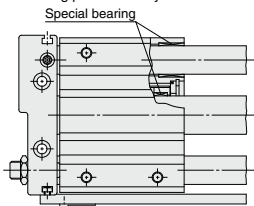

4 Outside of Cylinder Tube with Hard Chrome Plated Symbol -X322

The cylinder tube outer circumference is plated with hard chrome, which further reduces bearing abrasion.

Standard model no. - X322

● Outside of cylinder tube with hard chrome plated

Dimensions: Same as standard type

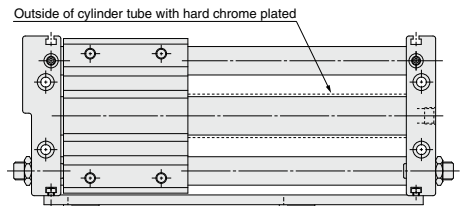

CY1S Series

5 Non-lubricated Exterior (With dust seal) Symbol -X324

No grease is applied to the external surface of the cylinder.
Suitable for environments where oil is not tolerated.
A felt dust seal is mounted to the external sliding part of the cylinder tube.

Standard model no. - X324

• Non-lubricated exterior
(with dust seal)

Dimensions: Same as standard type

Note) Although a felt dust seal is installed, foreign matter might be caught in the sliding parts of the cylinder. In that instance, consider installing a protective cover.

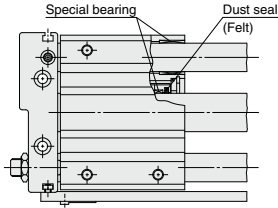

6 Switch Rails on Both Sides (With 2 pcs.) Symbol -X431

Applicable for short stroke with auto switch.

Standard model no. - X431

• Switch rails on both sides
(with 2 pcs.)

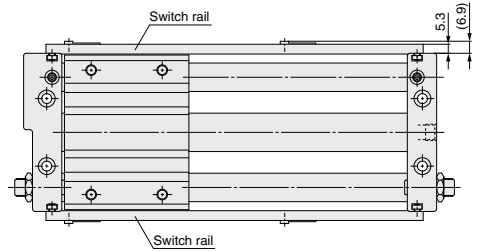

7 Mounting Surface Tapped Hole Type Symbol -X2423

The through hole mounting holes on both plates are tapped to allow the cylinders to also be mounted from the equipment side (cylinder mounted surface).

Dimension is the same as the standard

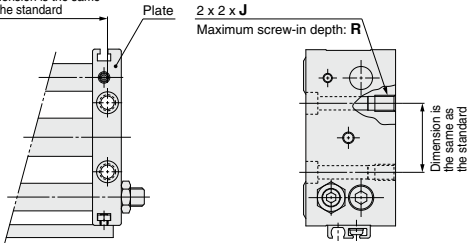

Bore size (mm)	J (Thread size)	R (Maximum screw-in depth)
6	M4 x 0.7	6.5
10	M5 x 0.8	9.5
15	M6 x 1	9.5
20	M6 x 1	9.5
25	M8 x 1.25	10
32	M10 x 1.5	15
40	M10 x 1.5	15



CY1S Series

Specific Product Precautions 1

Be sure to read this before handling the products. Refer to page 8 for safety instructions and pages 9 to 18 for actuator and auto switch precautions.

Operating Precautions

Warning

1. Be careful to the space between the plates and the slide block.

Take sufficient care to avoid getting your hands or fingers caught when the cylinder is operated.

2. Do not apply a load to a cylinder which is greater than the allowable value stated in the "Model Selection" pages.

This can cause a malfunction.

3. Be careful to the supply pressure and kinetic energy when performing an intermediate stop.

Fine end stroke adjustment is considered as an intermediate stop, so the considerations for an intermediate stop must be observed when making any fine adjustments.

When stopping the external slider in an intermediate position with an external stopper.

If the allowable pressure values are exceeded, the stopper position might be displaced or the external slider may become detached from the magnetic coupling and drop.

When stopping the piston slider in an intermediate position with the pneumatic circuit.

If the allowable kinetic energy values are exceeded, the stopper position might be displaced or the external slider may become detached from the magnetic coupling and drop.

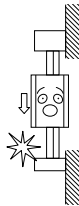

Caution

1. Do not use the cylinder in an environment where the cylinder is exposed to moisture, adhesive foreign matter, dust or liquid such as water or cutting fluid.

If the cylinder is used in an environment where the lubrication of the cylinders sliding parts is compromised, please consult SMC.

Mounting

Caution

1. Avoid operation with the external slider secured to the surface.

Secure the cylinder with the plates on both sides.

2. Make sure that the cylinder mounting surface has a flatness of 0.2 mm or less.

If the flatness of the mounting surface is not appropriate, the 2 guide shafts will become twisted and have an adverse effect to the performance of the product. This results in reduction of product life due to the increase in sliding resistance and premature wearing of the bushing.

The flatness of the cylinder mounting surface should be 0.2 mm or less, and the product should be mounted so that it can operate smoothly over the full stroke with the minimum operating pressure (0.18 MPa or less).

Disassembly and Maintenance

Warning

1. Use caution as the attractive power of the magnets is very strong.

When removing the external slider and piston slider from the cylinder tube for maintenance etc., handle with caution, since the magnets installed in each slider have a very strong attractive force.

Caution

1. Use caution when taking off the external slider, as the piston slider will be directly attracted to it.

When removing the external slider or piston slider from the cylinder tube, first force the sliders out of their magnetically coupled positions, and then remove them individually when there is no longer any holding force. If they are removed while still magnetically coupled, they will be directly attracted to one another and will not come apart.

2. Do not disassemble the magnetic components (piston slider, external slider).

This can cause a loss of holding force and malfunction.

3. When disassembling to replace the seals and wear ring, refer to the separate disassembly instructions.

4. The set screws in the figure below are for securing the guide shaft, so do not loosen them except for the purposes of replacing the seals.

This can cause a malfunction.

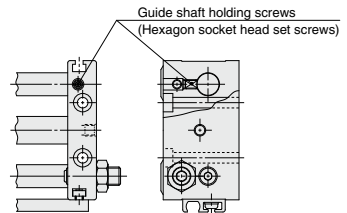

5. Use caution to the direction of the external slider and the piston slider.

There are an odd number of magnets for $\phi 6$ and $\phi 10$ ($\phi 6$: 5 pcs, $\phi 10$: 3 pcs), so the assembly direction is important. Refer to the figure below when performing disassembly or maintenance. Put the external slider and the internal slider together and insert the piston slider into the cylinder tube ensuring the positional relationship is correct as shown in Fig. 1.

If assembled incorrectly as shown in Fig. 2, remove and rotate the piston slider by 180°, then re-insert in the correct position. If the direction is not correct, it will be impossible to obtain the specified holding force.

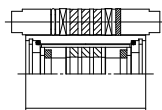

Fig. 1 Correct position

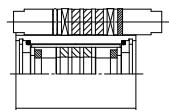

Fig. 2 Incorrect position



CY1S Series

Specific Product Precautions 2

Be sure to read this before handling the products. Refer to page 8 for safety instructions and pages 9 to 18 for actuator and auto switch precautions.

Stroke Setting

⚠ Caution

With bumper bolt

Loosen the hexagon nut, and move the bumper bolt to the set stroke position with a hexagon wrench or by hand. Tighten the hexagon nut to the torque values shown in the table below.

With shock absorber

The cylinder stroke is controlled by the position of the adjustment bolt. Parallel pins of smaller size to the rod diameter of the shock absorber are mounted on the slide block, and these pins collide with the adjustment bolt and shock absorber. Therefore, the stopper of the shock absorber should not come into contact with the slide block directly. (See the figure below.)

It is possible to adjust the stroke time of the shock absorber by adjusting the position of the shock absorber and adjustment bolt. However, if the effective stroke of the shock absorber is extremely short, the ability to absorb the impact will be reduced, leading to failure. Therefore, the position of the shock absorber is recommended to be approximately 0.2 mm behind the contact surface of the adjustment bolt (See figure below).

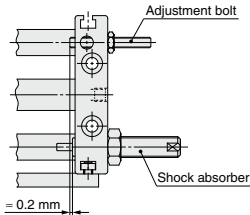

Bore size (mm)	Nut for bumper bolt		Nut for shock absorber		Nut for adjustment bolt	
	Thread size	Tightening torque (N·m)	Thread size	Tightening torque (N·m)	Thread size	Tightening torque (N·m)
6	M6 x 0.75	5.2	M6 x 0.75	0.85	M4 x 0.7	1.5
10	M8 x 1	12.5	M8 x 1	1.67		
15	M8 x 1	12.5	M8 x 1	1.67	M6 x 1	5.2
20	M10 x 1	24.5	M10 x 1	3.14		
25	M14 x 1.5	68.0	M14 x 1.5	10.80		
32	M20 x 1.5	204.0	M20 x 1.5	23.50	M8 x 1.25	12.5
40	M20 x 1.5	204.0	M20 x 1.5	23.50		

Caution when Replacing Shock Absorber

⚠ Caution

For the cylinder specification of shock absorber with adjustment bolt, the stroke will be maintained even when the shock absorber is replaced. However, if the position of the adjustment bolt is also changed, it will be necessary to reset the stroke position of the cylinder and shock absorber.

Service Life and Replacement Period of Shock Absorber

⚠ Caution

1. If the shock absorbing ability of the shock absorber is insufficient at the end of stroke, the cylinder, equipment or workpiece maybe damaged.
2. Perform maintenance for the shock absorber (RJ series) setting approximately 3 million operating cycles as a guide.

Note 1) The performance may vary depending on the operating conditions of the shock absorber.

Note 2) As a guide, the maintenance check for the shock absorber (RJ series) should be carried out after approximately 3 million operating cycles, and replace if necessary.

3. Refer to the RJ series catalog for Specific Product Precautions of the shock absorber.