

Clean Rodless Cylinder

CYP Series

ø15, ø32

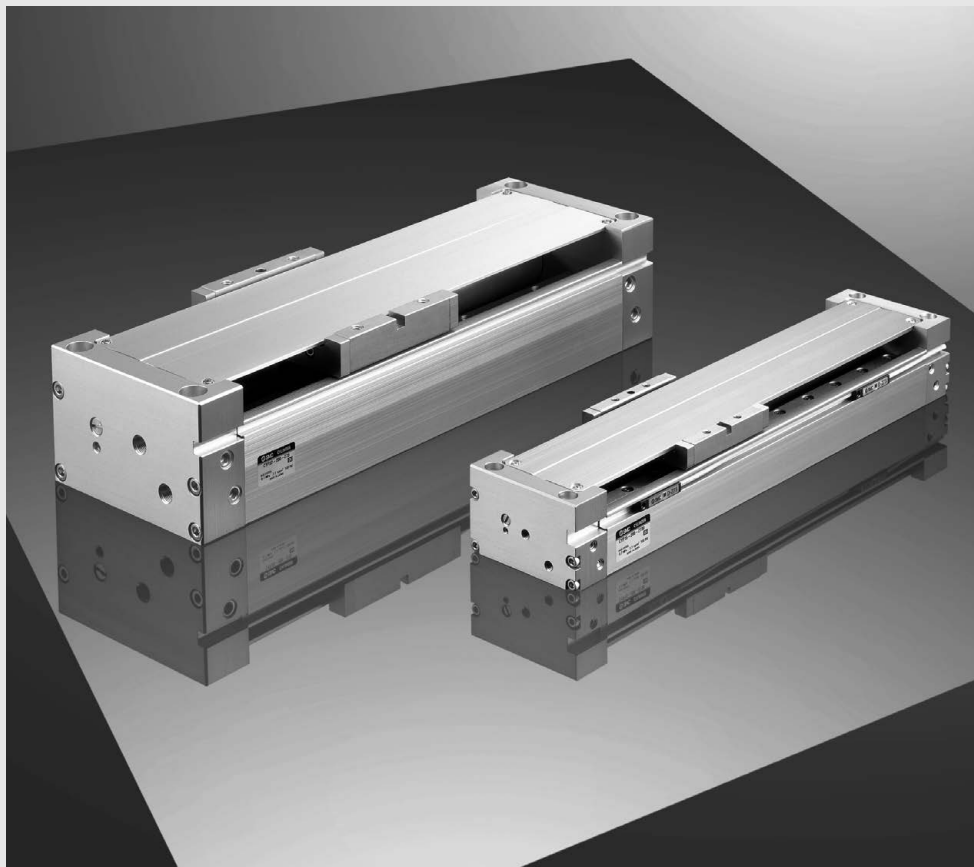

Magnetically coupled rodless cylinder for transfer in clean environments.

A magnetically coupled rodless cylinder that

Low particle generation: 1/20 (compared to previous series)

- High cleanliness is achieved with **non-contact construction** of the cylinder tube exterior and a **stainless steel linear guide (specially treated)**.
- Particle generation has been reduced to 1/20 compared to the 12-CY3B series (previous SMC product) even without vacuum suction.

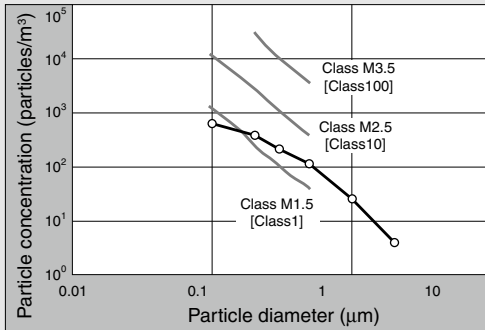

- Note 1) This chart indicates the level of cleanliness inside the measurement chamber.
 Note 2) The vertical axis shows the number of particles per unit volume (1 m³) of air which are no smaller than the particle size shown on the horizontal axis.
 Note 3) The gray lines show the upper concentration limit of the cleanliness class based on Fed.Std.209E-1992.
 Note 4) The plots indicate the 95% upper reliability limit value for time series data up to 500 thousand operation cycles. (Cylinder: CYP32-200, Workpiece weight: 5 kg, Average speed: 200 mm/s)
 Note 5) The data above provide a guide for selection but is not guaranteed.

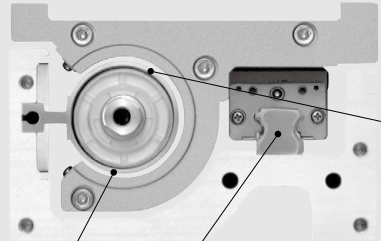

Stainless steel linear guide (specially treated)

The specially treated linear guide achieves low particulate generation, high linearity and high precision.

Non-contact construction

There is no particulate generation from sliding, because the construction avoids contact between the cylinder tube's exterior surface and the slide table's interior surface.

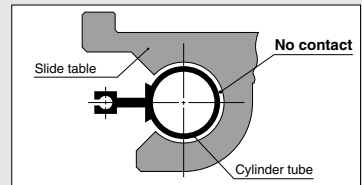

Piping port variations provide a high degree of freedom

Piping port positions can be selected to accommodate the installation.

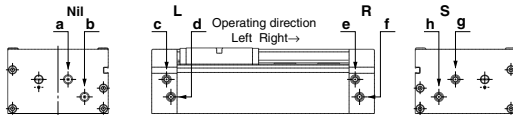

Note) Plugs are installed in ports other than those indicated for the model.

Model	Nil		L		R		S	
Piping port position	a	b	c	d	e	f	g	h
Operating direction	Right	Left	Right	Left	Right	Left	Right	Left



Cleaned, assembled and double packaged in a clean room

can be used for transfer in clean environments

Long stroke (Max. 700 mm)

Special cylinder tube

A special cylinder tube is employed using extruded aluminum material. Even long strokes are not subject to deflection because of direct attachment to the cylinder body, and non-contact construction is achieved through combination with a linear guide.

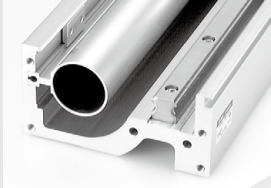

Shock-free

A **sine cushion** is used at the end of the stroke. Smooth acceleration and deceleration are possible at 5 m/s² or less.

Sine cushion

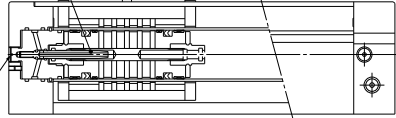

Stroke adjustment screw

Stroke adjustment

The **stroke adjustment screw** allows fine control of the stroke (± 1 mm on each side)

Series Variations

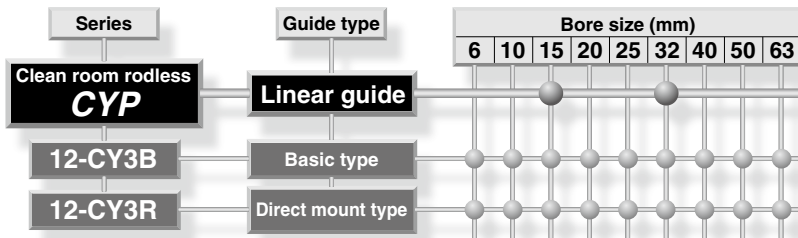
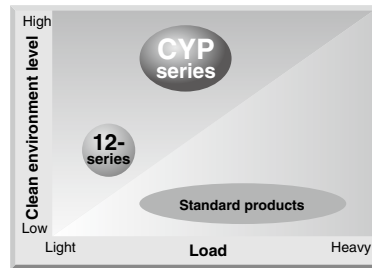

* For details about the 12-series, refer to the Web Catalog.

CYP Series Model Selection

Caution on Design (1)

The load mass allowable moment differs depending on the workpiece mounting method, cylinder mounting orientation and piston speed. In making a determination of usability, do not allow the sum ($\Sigma \alpha n$) of the load factors (αn) for each mass and moment to exceed "1".

$$\Sigma \alpha n = \frac{\text{Load mass (m)}}{\text{Max. load mass (m max)}} + \frac{\text{Static moment (M)}}{\text{Allowable static moment (M max)}} + \frac{\text{Dynamic moment (Me)}}{\text{Allowable dynamic moment (Me max)}} \leq 1$$

Load Mass

Max. load mass (kg)

Model	m max
CYP15	1
CYP32	5

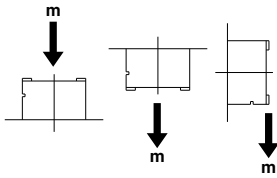

Moment

Allowable moment (Static moment/Dynamic moment)

Model	(N·m)		
	M1	M2	M3
CYP15	0.3	0.6	0.3
CYP32	3	4	3

Static Moment

Moment generated by the workpiece weight even when the cylinder is stopped

■ Pitch moment

$$M1 = m \times g \times (L + B) \times 10^{-3}$$

■ Roll moment

$$M2 = m \times g \times (L + B) \times 10^{-3}$$

■ Yaw moment

$$M3 = m \times g \times (L + A) \times 10^{-3}$$

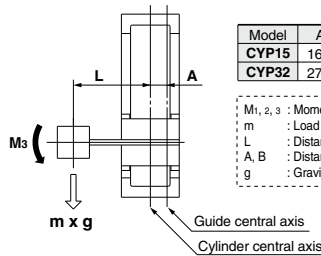
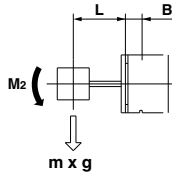
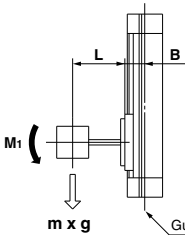

Model	(mm)	
	A	B
CYP15	16.5	25.5
CYP32	27.0	48.0

M _{1, 2, 3}	: Moment [N·m]
m	: Load mass [kg]
L	: Distance to load center of gravity [mm]
A, B	: Distance to guide shaft [mm]
g	: Gravitational acceleration [9.8 m/s ²]

Dynamic Moment

Moment generated by the load equivalent to impact at the stroke end

$$We = 5 \times 10^{-3} \times m \times g \times U$$

We	: Load equivalent to impact [N]	U	: Max. speed [mm/s]
m	: Load mass [kg]	g	: Gravitational acceleration [9.8 m/s ²]

■ Pitch moment

$$Me1 = 1/3 \cdot We \cdot (L + B) \cdot 10^{-3}$$

· Average load coefficient

■ Yaw moment

$$Me3 = 1/3 \cdot We \cdot (L + A) \cdot 10^{-3}$$

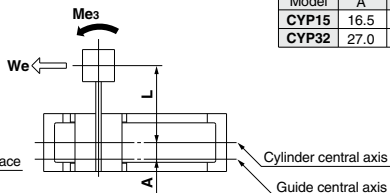
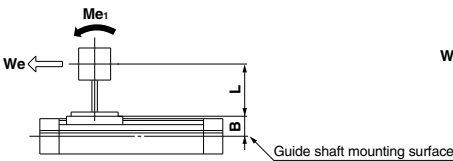

Model	(mm)	
	A	B
CYP15	16.5	25.5
CYP32	27.0	48.0

Selection Calculation

The selection calculation finds the load factors (α_n) of the items below, where the total ($\sum \alpha_n$) does not exceed 1.

$$\sum \alpha_n = \alpha_1 + \alpha_2 + \alpha_3 \leq 1$$

Item	Load factor α_n	Note
1. Max. load mass	$\alpha_1 = m/m_{\max}$	Review m m _{max} is the maximum load mass
2. Static moment	$\alpha_2 = M/M_{\max}$	Review M1, M2, M3 M _{max} is the allowable moment
3. Dynamic moment	$\alpha_3 = Me/Me_{\max}$	Review Me1, Me3 Me _{max} is the allowable moment

Calculation Example

Operating Conditions

Cylinder: **CYP32**
 Mounting: Horizontal wall mounting
 Maximum speed: U = 300 [mm/s]
 Load mass: m = 1 [kg] (excluding mass of arm section)
 L1 = 50 [mm]
 L2 = 50 [mm]

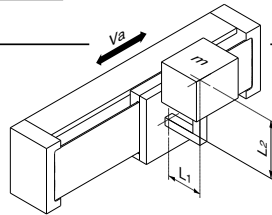

Item	Load factor α_n	Note
1. Maximum load mass 	$\alpha_1 = m/m_{\max}$ $= 1/5$ $= \mathbf{0.20}$	Review m.
2. Static moment 	$M_2 = m \cdot g \cdot (L_1 + B) \cdot 10^{-3}$ $= 1 \cdot 9.8 \cdot (50 + 48) \cdot 10^{-3}$ $= 0.96 \text{ [N}\cdot\text{m]}$ $\alpha_2 = M_2/M_2 \text{ max}$ $= 0.96/4$ $= \mathbf{0.24}$	Review M2. Since M1 & M3 are not generated, review is unnecessary.
3. Dynamic moment 	$We = 5 \times 10^{-3} \cdot m \cdot g \cdot U$ $= 5 \times 10^{-3} \cdot 1 \cdot 9.8 \cdot 300$ $= 14.7 \text{ [N]}$ $Me_3 = 1/3 \cdot We \cdot (L_2 + A) \cdot 10^{-3}$ $= 1/3 \cdot 14.7 \cdot (50 + 27) \cdot 10^{-3}$ $= 0.38 \text{ [N}\cdot\text{m]}$ $\alpha_3 = Me_3/Me_3 \text{ max}$ $= 0.38/3$ $= \mathbf{0.13}$	Review Me3.
	$Me_1 = 1/3 \cdot We \cdot (L_1 + B) \cdot 10^{-3}$ $= 1/3 \cdot 14.7 \cdot (50 + 48) \cdot 10^{-3}$ $= 0.48 \text{ [N}\cdot\text{m]}$ $\alpha_4 = Me_1/Me_1 \text{ max}$ $= 0.48/3$ $= \mathbf{0.16}$	Review Me1.

$$\begin{aligned} \sum \alpha_n &= \alpha_1 + \alpha_2 + \alpha_3 + \alpha_4 \\ &= 0.20 + 0.24 + 0.13 + 0.16 \\ &= 0.73 \end{aligned}$$

$\sum \alpha_n = 0.73 \leq 1$ Therefore it can be used.

Caution on Design (2)

Table Deflection (Note)

Table deflection due to pitch moment load

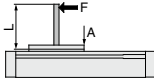

$$M_1 = F \times L$$

Table deflection due to roll moment load

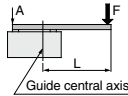

$$M_2 = F \times L$$

Table deflection due to yaw moment load

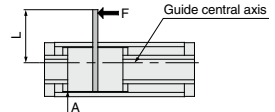

$$M_3 = F \times L$$

Note) Displacement of Section A when force acts on Section F

CYP15 (M1)

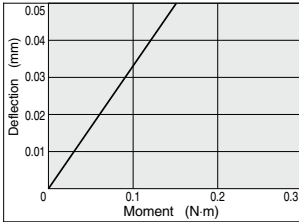

CYP15 (M2)

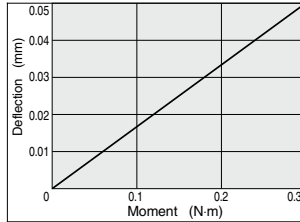

CYP15 (M3)

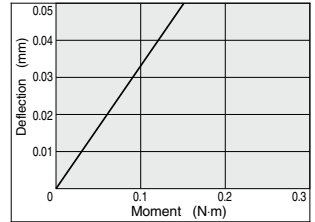

CYP32 (M1)

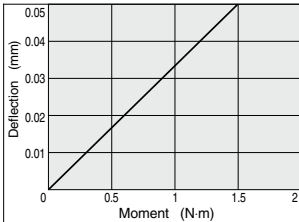

CYP32 (M2)

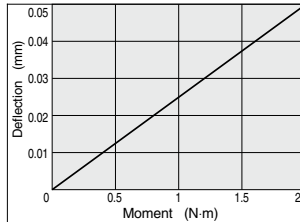

CYP32 (M3)

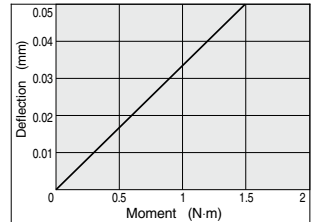

Note) Extend lines in the graphs to indicate amount of deflection when moments larger than the above are applied.

Note) Indicates the displacement (rigidity) on the slide table from the position where the reaction force is generated when the torque is applied to the slide table.
(Reference values) Please contact SMC for the accuracy.

Vertical Operation

When using in vertical operation, prevention of workpiece dropping due to breaking of the magnetic coupling should be considered. The allowable load mass and maximum operating pressure should be as shown in the table below.

When the cylinder is mounted vertically or sideling, a slider may move downwards due to the self-weight or workpiece mass. If an accurate stopping position is required at the stroke end or the middle of stroke, use an external stopper to secure the accurate positioning.

Model	Allowable load mass mv (kg)	Maximum operating pressure Pv (MPa)
CYP15	1	0.3
CYP32	5	

Intermediate Stop

The cushion effect (smooth start-up, soft stop) exists only before the stroke end in the stroke ranges indicated in the table below.

The cushion effect (smooth start-up, soft stop) cannot be obtained in an intermediate stop or return from an intermediate stop using an external stopper, etc.

When using an intermediate stop considering the above information, implement measures to prevent particulate generation and set the operating pressure to no more than 0.3 MPa.

Cushion Stroke

Model	Stroke (mm)
CYP15	25
CYP32	30

Clean Rodless Cylinder

CYP Series

ø15, ø32

How to Order

CYP 15 - 200 - Y7BW

Clean room rodless cylinder

Bore size

15	15 mm
32	32 mm

Standard stroke

Bore size (mm)	Standard stroke (mm)
15, 32	100, 150, 200, 250, 300, 350 400, 450, 500, 600, 700

Note 1) Please consult with SMC if the maximum stroke is exceeded.
Note 2) Intermediate strokes are available as a special order.

Number of auto switches

Nil	2 pcs.
S	1 pc.
n	"n" pcs.

Auto switch

Nil	Without auto switch (Built-in magnet)
-----	---------------------------------------

For the applicable auto switch model, refer to the table below.

Piping port location

Nil	a	Operating direction: Right
	b	Operating direction: Left
L	c	Operating direction: Right
	d	Operating direction: Left
R	e	Operating direction: Right
	f	Operating direction: Left
S	g	Operating direction: Right
	h	Operating direction: Left

Piping Port Location

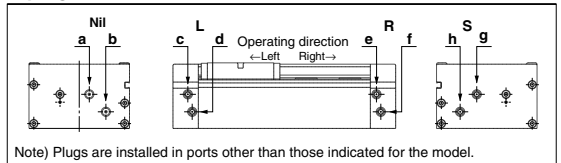

Applicable Auto Switches

Refer to pages 1289 to 1383 for further information on auto switches.

Type	Special function	Electrical entry	Indicator light	Wiring (Output)	Load voltage		Auto switch model		Lead wire length (mm)*			Pre-wired connector	Applicable load			
					DC	AC	Electrical entry direction	In-line	0.5 (Nil)	3 (L)	5 (Z)					
Solid state auto switch	—	Grommet	Yes	3-wire (NPN)	24 V	5 V, 12 V	—	Y69A	Y59A	●	●	○	IC circuit	Relay, PLC		
				3-wire (PNP)				Y7PV	Y7P	●	●	○				
				2-wire				Y69B	Y59B	●	●	○			—	
				3-wire (NPN)				Y7NWV	Y7NW	●	●	○			IC circuit	
				3-wire (PNP)				Y7PWV	Y7PW	●	●	○				
				2-wire				Y7BWW	Y7BW	●	●	○				
Reed auto switch	—	Grommet	Yes	3-wire	24 V	5 V	—	—	Z76	●	●	—	IC circuit	—		
				2-wire				12 V	100 V	—	Z73	●	●	●	—	Relay, PLC
								5 V, 12 V	100 V or less	—	Z80	●	●	—	IC circuit	

* Lead wire length symbols: 0.5 m Nil (Example) Y7BW
3 m L Y7BWL
5 m Z Y7BWZ

* Auto switches marked with a "○" symbol are produced upon receipt of order.

* Refer to pages 1358 and 1359 for the details of auto switches with a pre-wired connector.

* Normally closed (NC = b contact) solid state auto switches (D-Y7G/Y7H types) are also available. Refer to page 1310 for details.

* Auto switches are shipped together, (but not assembled).



Symbol

Air cushion
(With magnet)



Specifications

Bore size (mm)	15	32
Fluid	Air	
Action	Double acting	
Proof pressure	0.5 MPa	
Operating pressure range	0.05 to 0.3 MPa	
Ambient and fluid temperature	-10 to 60°C (No freezing)	
Piston speed (Max.) ^(Note)	50 to 300 mm/s	
Lubrication	Not required (Non-lube)	
Stroke adjustment	±1 mm on each side (±2 mm total)	
Cushion	Sine cushion (Air cushion)	
Port size	M5 x 0.8	Rc (PT) 1/8
Magnet holding force (N)	59	268

Note) The piston speed above indicates the maximum speed. It takes approx. 0.5 seconds for a single side and approx. 1 second for both sides for a sliding table to move through the cushion stroke starting from the stroke end.

Weight

Model	Standard stroke (mm)										
	100	150	200	250	300	350	400	450	500	600	700
CYP15	1.2	1.4	1.6	1.7	1.9	2.0	2.2	2.4	2.5	2.8	3.2
CYP32	4.2	4.6	5.0	5.5	5.9	6.3	6.7	7.1	7.5	8.3	9.1

Theoretical Output

Bore size (mm)	Piston area (mm ²)	Operating pressure (MPa)		
		0.1	0.2	0.3
15	176	18	35	53
32	804	80	161	241

Construction

CYP15

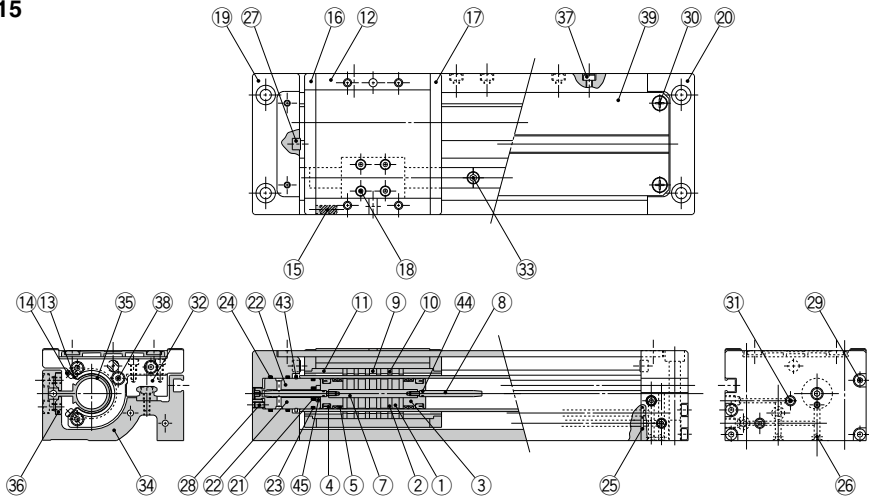

CYP32

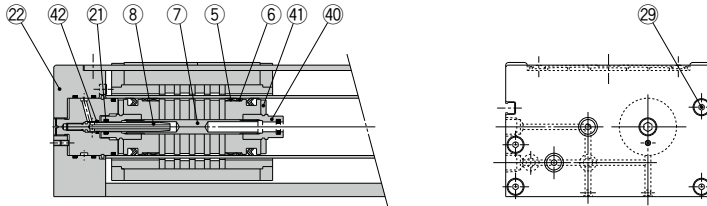

Component Parts

No.	Description	Material	Note
1	Magnet A	—	
2	Piston side yoke	Rolled steel plate	Zinc chromated
3	Piston	Brass/Aluminum alloy	ø15: Electroless nickel plated, ø32: Chromated
4	Piston seal	NBR	
5	Wear ring A	Special resin	
6	Wear ring	Special resin	
7	Shaft	Stainless steel	
8	Cushion ring	Stainless steel/Brass	ø15: Electroless nickel plated
9	Magnet B	—	
10	External slider side yoke	Rolled steel	Electroless nickel plated
11	Hold spacer	Aluminum alloy	Electroless nickel plated
12	Slide table	Aluminum alloy	Electroless nickel plated
13	Insertion guide plate	Stainless steel	
14	Round head Phillips screw	Carbon steel	Nickel plated
15	Magnet	—	
16	Side plate A	Aluminum alloy	Electroless nickel plated
17	Side plate B	Aluminum alloy	Electroless nickel plated
18	Hexagon socket head cap screw	Chrome molybdenum steel	Nickel plated
19	Plate A	Aluminum alloy	Clear hard anodized
20	Plate B	Aluminum alloy	Clear hard anodized
21	Cushion seal	NBR	
22	Inner cover	Aluminum alloy	Clear hard anodized

No.	Description	Material	Note
23	Cylinder tube gasket	NBR	
24	O-ring	NBR	
25	O-ring	NBR	
26	Steel ball	Carbon steel	
27	Bumper	Polyurethane	
28	Hexagon socket head set screw	Chrome molybdenum steel	Nickel plated
29	Hexagon socket head cap screw	Chrome molybdenum steel	Nickel plated
30	Round head Phillips screw	Stainless steel	Nickel plated
31	Hexagon socket head plug	Chrome molybdenum steel	Nickel plated
32	Linear guide	Stainless steel	
33	Hexagon socket head cap screw	Chrome molybdenum steel	Nickel plated
34	Body	Aluminum alloy	Clear hard anodized
35	Cylinder tube	Aluminum alloy	Hard anodized
36	Tube attaching bracket	Aluminum alloy	Clear hard anodized
37	Hexagon socket head cap screw	Chrome molybdenum steel	Nickel plated
38	Hexagon socket head cap screw	Chrome molybdenum steel	Nickel plated
39	Top cover	Aluminum alloy	Clear hard anodized
40	Cushion seal holder	Aluminum alloy	Chromated
41	Bumper	Urethane	CYP32 only
42	O-ring	NBR	
43	Type C retaining ring for axis	Carbon tool steel	
44	O-ring	NBR	
45	Retaining plate	Aluminum alloy	CYP15 only

CYP Series

Dimensions

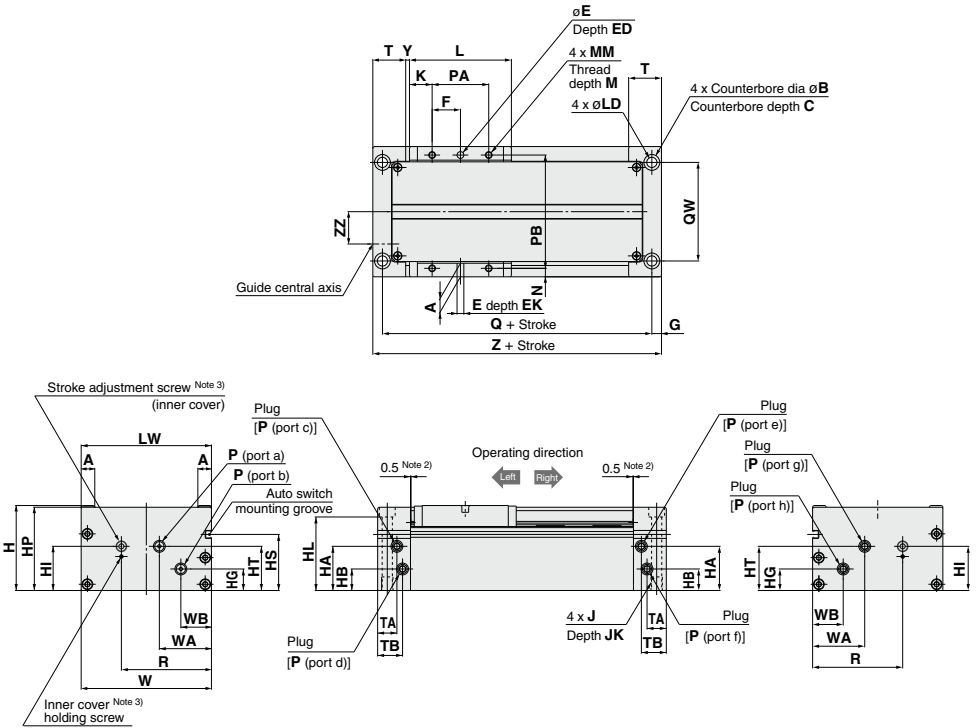

(mm)

Model	A	B	C	E	ED	EK	F	G	H	HA	HB	HG	HI	HL	HP	HS	HT	J	JK	K	L
CYP15	8	9.5	5.4	4H9 $^{+0.030}$ 0	9.5	4	12.5	6.5	45	19.5	8.5	8.5	23	38.6	44	27	19.5	M6 x 1	10	21	67
CYP32	12	14	8.6	6H9 $^{+0.030}$ 0	13	6	25	8.5	75	39	19	19	39	64.9	73.5	49.5	39	M10 x 1.5	12	20	90

Model	LD	LW	MM	M	N	P	PA	PB	Q	QW	R	T	TA	TB	W	WA	WB	Y	Z	ZZ
CYP15	5.6	69	M4 x 0.7	6	4.5	M5 x 0.8	25	60	105	48	45	23	13	18	69	32	17	2.5	118	16.5
CYP32	9.2	115	M6 x 1	8	7.5	Rc (PT) 1/8	50	100	138	87	79.5	29	17	22	115	46	27	3.5	155	29

Note 1) These dimension drawings indicate the case of piping port location "Nil".

Note 2) These dimensions indicate the protruding portion of the bumper.

Note 3) Refer to "Specific Product Precautions" [Cushion Effect (Sine Cushion) and Stroke Adjustment] on page 1287.

Model	Nil	L	R	S				
Piping port location	a	b	c	d	e	f	g	h
Operating direction	Right	Left	Right	Left	Right	Left	Right	Left

CYP Series Auto Switch Mounting

Proper Auto Switch Mounting Position Detection (Detection at stroke end)

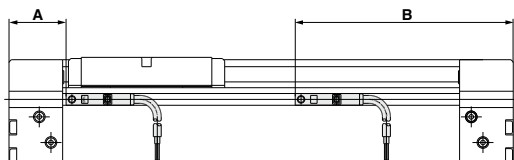

Operating Range

Cylinder model \ Auto switch model	D-Z7□ D-Z80	D-Y7□W D-Y7□WV D-Y5□ D-Y6□ D-Y7P D-Y7PV
	CYP15	6.5
CYP32	9.5	3

Note) Operating ranges are standards including hysteresis, and are not guaranteed. (variations on the order of ±30%)

Large variations may occur depending on the surrounding environment.

Proper Auto Switch Mounting Position

Auto switch model \ Cylinder model	A			B		
	D-Z7□ D-Z80	D-Y7□W D-Y7□WV	D-Y5□ D-Y6□ D-Y7P D-Y7PV	D-Z7□ D-Z80	D-Y7□W D-Y7□WV	D-Y5□ D-Y6□ D-Y7P D-Y7PV
CYP15	24.5			93.5		
CYP32	33			122		

Note) Adjust the auto switch after confirming the operating conditions in the actual setting.

Mounting of Auto Switch

When mounting auto switches, they should be inserted into the cylinder's auto switch installation groove from the direction shown in the drawing on the right. After setting in the mounting position, use a flat head watchmaker's screwdriver to tighten the auto switch mounting screw which is included.

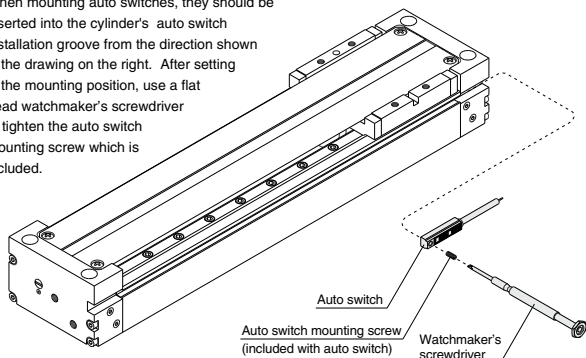

Note) When tightening the auto switch mounting screw (included with the auto switch), use a watchmaker's screwdriver with a handle about 5 to 6 mm in diameter. The tightening torque should be approximately 0.05 to 0.1 N·m.



CYP Series

Specific Product Precautions 1

Be sure to read this before handling the products.

Refer to page 8 for safety instructions and pages 9 to 18 for actuator and auto switch precautions.

Handling

Caution

1. Open the inner package of the double packaged clean series inside a clean room or other clean environment.
2. Perform parts replacement and disassembly work in a clean room after exhausting compressed air in the piping outside the clean room.

Mounting

Caution

1. **Take care to avoid striking the cylinder tube with other objects or handling it in a way that could cause deformation.**
The cylinder tube and slider units have a non-contact construction. For this reason, even a slight deformation or slippage of position can cause malfunction and loss of durability, as well as a danger of degrading the particulate generation characteristics.
2. **Do not scratch or gouge the linear guide by striking it with other objects.**
Since the linear guide is specially treated for maximum suppression of particulate generation due to sliding, even a slight scratch can cause malfunction and loss of durability, as well as a danger of degrading the particulate generation characteristics.
3. **Since the slide table is supported by precision bearings, do not apply strong impacts or excessive moment when mounting workpieces.**
The slide table may contact with the cylinder tube.
4. **Be sure to operate the cylinder with the plates on both sides secured.**
Avoid applications in which the slide table or only one plate is secured.
5. **When changing the ports to be used, be sure that unused ports are securely sealed.**
Take sufficient care in sealing unused ports, because if ports are not properly sealed air can leak from the ports and particulate generation characteristics can be degraded.
6. **Do not loosen the bolts that fix the block of the linear guide and slide table.**
The slide table may contact with the cylinder tube.
7. **It is recommended to place the load's center of gravity on the cylinder linear guide.**
The linear guide position is off-set from the cylinder center axis, so it is recommended to place the load's center of gravity on the linear guide.

Operation

Caution

1. **The maximum operating pressure for the clean rodless cylinder is 0.3 MPa.**
If the maximum operating pressure of 0.3 MPa for the clean rodless cylinder is exceeded, the magnetic coupling can be broken, causing a danger of malfunction or degradation of particulate generation characteristics, etc.
2. **The product can be used with a direct load applied within the allowable range, but careful alignment is necessary when connecting to a load having an external guide mechanism.**
Since alignment variations increase as the stroke gets longer, use a connection method which can absorb these variations and consider measures to control particulate generation.
3. **When used for vertical operation, use caution regarding possible dropping due to separation of the magnetic coupling.**
When used for vertical operation, use caution as there is a possibility of dropping due to separation of the magnetic coupling if a load (pressure) greater than the allowable value is applied.
4. **Do not operate with the magnetic coupling out of position.**
If the magnetic coupling is out of position, push the external slider by hand (or the piston slider with air pressure) back to the proper position at the stroke end.
5. **Do not supply lubrication, as this is a non-lube product.**
The interior of the cylinder is lubricated at the factory, and lubrication with turbine oil, etc., will not satisfy the product's specifications.



CYP Series

Specific Product Precautions 2

Be sure to read this before handling the products.

Refer to page 8 for safety instructions and pages 9 to 18 for actuator and auto switch precautions.

Speed Adjustment

⚠ Caution

1. A throttle valve for clean room use is recommended for speed adjustment. (Please consult with SMC regarding equipment and methods to be used.)

Speed adjustment can also be performed with a meter-in or meter-out type speed controller for clean room use, but it may not be possible to obtain smooth starting and stopping operation.

Throttle Valves and Dual Speed Controllers for Recommended Speed Adjustment of CYP Cylinders

Throttle valve		Series	Model	
			CYP15	CYP32
Metal body piping type	Elbow type	10-AS1200-M5-X216	10-AS2200-01-X214	
	In-line type	10-AS1000-M5-X214	10-AS2000-01-X209	
Resin body with One-touch fitting	Elbow type (throttle valve)	10-AS1201F-M5-04-X214	10-AS2201F-01-04-X214	
		10-AS1201F-M5-06-X214	10-AS2201F-01-06-X214	
	Universal type (throttle valve)	10-AS1301F-M5-04-X214	10-AS2301F-01-04-X214	
		10-AS1301F-M5-06-X214	10-AS2301F-01-06-X214	
	In-line type (throttle valve)	10-AS1001F-04-X214	10-AS2001F-04-X214	
		10-AS1001F-06-X214	10-AS2001F-06-X214	
Dual type (speed controller)	10-ASD230F-M5-04	10-ASD330F-01-06		
	10-ASD230F-M5-06	10-ASD330F-01-08		
With clean One-touch fitting	Elbow type/Brass (throttle valve)	AS1201FPG-M5-04-X214	AS2201FPG-01-04-X214	
		AS1201FPG-M5-06-X214	AS2201FPG-01-06-X214	
	—	AS2201FPG-01-08-X214		
	Elbow type/Stainless steel 304 (throttle valve)	AS1201FPG-M5-04-X214	AS2201FPG-01-04-X214	
		AS1201FPG-M5-06-X214	AS2201FPG-01-06-X214	
	—	AS2201FPG-01-08-X214		

Note 1) Refer to the **Web Catalog** (How to Use Clean Series) for the selection of the metal body piping type and the cylinders with a resin-body One-touch fitting.

Note 2) Refer to the Pneumatic Clean Series (fittings for air line equipment) for the fittings used for the metal body piping type.

2. In the case of vertical mounting, a system with a reduced pressure supply circuit installed on the down side is recommended. (This is effective against upward starting delays and for conservation of air.)

Cushion Effect (Sine Cushion) and Stroke Adjustment

⚠ Caution

1. A sine cushion (smooth start, soft stop) function is included in the standard specifications.

Due to the nature of a sine cushion, adjustment of the cushion effect is not possible. There is no cushion needle adjustment as in the case of current cushion mechanisms. The cushioning performance on each end may vary slightly.

2. The stroke end adjustment is a mechanism to adapt the slide table's stroke end position to a mechanical stopper on other equipment, etc.

(Adjustment range: Total of both sides ± 2 mm) To ensure safety, perform adjustment after shutting off the drive air, releasing the residual pressure and implementing drop prevention measures, etc.

- 1) Loosen the inner cover holding screw with a hexagon wrench. (When adjusting strokes, be sure to adjust after loosening set screws. If rotating stroke adjustment screws without loosening them, hexagon holes for adjustment screws may deform and stroke adjustment cannot be performed.)
- 2) To match the position with a mechanical stopper on other equipment, etc., rotate the stroke adjustment screws of the inner cover with a hexagon wrench and move the inner cover back and forth in the axial direction. Approximately 1 mm of adjustment is possible with one rotation. (Stroke adjustment screw rotational direction: Left rotation \rightarrow +stroke, Right rotation \rightarrow -stroke)
- 3) The maximum adjustment on one side is ± 1 mm. A total adjustment of approximately ± 2 mm is possible using both sides.
- 4) After adjusting the set stroke, tighten the inner cover holding screw with a hexagon wrench.

Inner Cover Holding Screw Tightening Torque [N·m] and Hexagon Wrench

Model	Inner cover holding screw			Stroke adjustment screw
	Screw size	Tightening torque	Hexagon wrench (Nominal size)	Hexagon wrench (Nominal size)
CYP15	M3 x 0.5	0.3	1.5	2.5
CYP32	M6 x 1	2.45	3	4

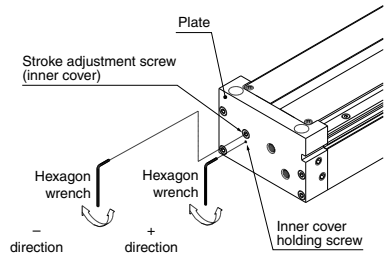



CYP Series

Specific Product Precautions 3

Be sure to read this before handling the products.

Refer to page 8 for safety instructions and pages 9 to 18 for actuator and auto switch precautions.

Maintenance

⚠ Caution

1. Never disassemble the cylinder tube or linear guide, etc.
If disassembled, the slide table may touch the outside surface of the cylinder tube resulting in a degradation of particulate generation characteristics.
2. Cylinder maintenance should be performed roughly at the operating cycle of 500 thousand or operating distance of 400 km.

Particulate Generation Characteristics

⚠ Caution

1. In order to maintain the particulate generation grade, use operation of 500 thousand cycles or travel distance of about 400 km as a standard. (Graph (1) below)
If operation is continued beyond the recommended values, lubrication failure of the linear guide and loss of particulate generation characteristics may occur.

Graph (1)

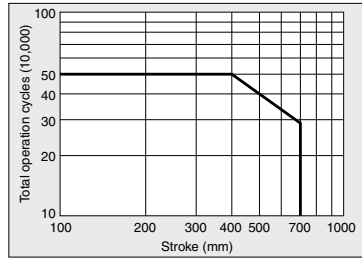

Graph (2)

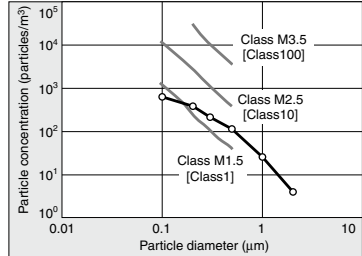

Note 1) This chart indicates the level of cleanliness inside the measurement chamber.

Note 2) The vertical axis shows the number of particles per unit volume (1 m³) of air which are no smaller than the particle size shown on the horizontal axis.

Note 3) The gray lines show the upper concentration limit of the cleanliness class based on Fed. Std. 209E-1992.

Note 4) The plots indicate the 95% upper reliability limit value for time series data up to 500 thousand operation cycles.

(Cylinder: CYP32-200, Workpiece weight: 5 kg, Average speed: 200 mm/s)

Note 5) The data above provides a guide for selection but is not guaranteed.

2. When the amount of grease at the linear guide is insufficient depending on the operating conditions, regular application of grease is recommended.

In such cases, the amount of dust may temporarily increase. After operating the cylinder for a short period of time, increased dust gradually decreases.