





# Low Speed Cylinders

## CJ2X/CM2X/CQSX/CQ2X/CUX Series

Series	Action	Bore size (mm)	Minimum operating speed (mm/s)	Page
<b>CJ2X</b> 	Double acting	10, 16	1	264
<b>CM2X</b> 		20, 25, 32, 40	0.5	280
<b>CQSX</b> 		12, 16	1	299
		20, 25	0.5	
<b>CQ2X</b> 		32, 40, 50, 63, 80, 100	0.5	308
<b>CUX</b> 	10, 16	1	323	
	20, 25, 32	0.5		

### Clean Series

#### Air Cylinders 10-/11-CM2X Series

Page 298



#### Compact Cylinders 10-/11-CQSX Series

Page 307



#### Compact Cylinders 10-/11-CQ2X Series

Page 322



Refer to the **Web Catalog** for low-speed rotary actuators

#### Low-Speed Compact Rotary Actuator CRQ2X Series



#### Low-Speed Rotary Table MSQX Series



# Low Speed Cylinder Double Acting, Single Rod

# CJ2X Series

ø10, ø16

RoHS

## How to Order

CJ2X B 16 - 60 □ Z - □ V

With auto switch

CDJ2X B 16 - 60 □ Z - N W - M9BW □ - B

With auto switch (Built-in magnet)

Low speed cylinder

### 1 Mounting

B	Basic
E	Double-side bossed
D	Double clevis
L	Single foot
M	Double foot
F	Rod flange
G	Head flange

\* Foot/Flange brackets are shipped together with the product, but not assembled.

### 6 Rod end bracket

Nil	None
V	Single knuckle joint
W**	Double knuckle joint
T	Rod end cap (Flat type)
U	Rod end cap (Round type)

\* Rod end bracket is shipped together with the product, but not assembled.

\*\* A knuckle joint pin is not provided with the single knuckle joint.

\*\* Refer to page 271 for the double knuckle joint (with one-touch connecting pin).



### 2 Bore size

10	10 mm
16	16 mm

### 3 Cylinder standard stroke (mm)

Refer to "Standard Strokes" on page 265.

### 4 Head cover port location

Nil	Perpendicular to axis	
R	Axial	

\* For double clevis, the product is perpendicular to the cylinder axis.

\* For double-side bossed, the product is perpendicular to the cylinder axis.

### 5 Pivot bracket

Nil	None
N	Pivot bracket is shipped together with the product.

\* Only for CJ2D (double clevis)  
\* Pivot bracket is shipped together with the product, but not assembled.

### 7 Auto switch

Nil	Without auto switch
-----	---------------------

\* For applicable auto switches, refer to the table below.

### 9 Auto switch mounting type

A	Rail mounting
B	Band mounting

\* For rail mounting, screws and nuts for 2 auto switches come with the rail.

\* Refer to page 278 for auto switch mounting brackets.

### 8 Number of auto switches

Nil	2 pcs.
S	1 pc.
n	"n" pcs.

## Applicable Auto Switches/Refer to pages 1341 to 1435 for further information on auto switches.

Type	Special function	Electrical entry	Indicator/light	Wiring (Output)	Load voltage		Auto switch model				Lead wire length (m)				Pre-wired connector	Applicable load	
					DC	AC	Band mounting		Rail mounting		0.5 (Nil)	1 (M)	3 (L)	5 (Z)			None (N)
							Perpendicular	In-line	Perpendicular	In-line							
Solid state auto switch	—	Grommet	3-wire (NPN)	3-wire (PNP)	5 V, 12 V	—	M9NV	M9N	M9NV	M9N	●	●	●	○	○	IC circuit	
							M9PV	M9P	M9PV	M9P	●	●	●	○	○		
		Connector	2-wire	12 V	—	M9BV	M9B	M9BV	M9B	●	●	●	○	○	○	—	
						—	H7C	J79C	—	●	—	●	●	—	—		
	Diagnostic indication (2-color indicator)	Yes	Grommet	3-wire (NPN)	3-wire (PNP)	5 V, 12 V	24 V	M9NV	M9N	M9NV	M9N	●	●	●	○	○	IC circuit
								M9PV	M9P	M9PV	M9P	●	●	●	○	○	
		Connector	2-wire	12 V	—	M9BV	M9B	M9BV	M9B	●	●	●	○	○	○	—	
						M9NAV*1	M9NA*1	M9NAV*1	M9NA*1	○	○	○	○	○	○	○	IC circuit
With diagnostic output (2-color indicator)	No	Grommet	3-wire (NPN)	3-wire (PNP)	5 V, 12 V	—	M9PAV*1	M9PA*1	M9PAV*1	M9PA*1	○	○	○	○	○	IC circuit	
							M9BAV*1	M9BA*1	M9BAV*1	M9BA*1	○	○	○	○	○		○
Reed auto switch	—	Yes	3-wire (NPN equivalent)	—	5 V	—	A96V	A96	A96V	A96	●	—	●	—	—	IC circuit	
							—	200 V	—	—	A72	A72H	●	—	●		—
		No	2-wire	24 V	12 V	100 V	A93V*2	A93	A93V*2	A93	●	●	●	—	—	IC circuit	
							100 V or less	A90V	A90	A90V	A90	●	—	●	—		—
	Diagnostic indication (2-color indicator)	Yes	Grommet	—	—	24 V or less	—	—	C73C	A73C	—	●	—	●	●	IC circuit	
								—	C80C	A80C	—	●	—	●	●		—
		Connector	No	—	—	—	—	—	—	A79W	—	—	●	—	●	—	—
									—	—	—	—	●	—	●	—	—

\*1 Water resistant type auto switches can be mounted on the above models, but in such case SMC cannot guarantee water resistance.

Please consult with SMC regarding water resistant types with the above model numbers.

\*2 1 m type lead wire is only applicable to D-A93.

\* Lead wire length symbols: 0.5 m ..... Nil (Example) M9NW  
1 m ..... M (Example) M9NWM  
3 m ..... L (Example) M9NWL  
5 m ..... Z (Example) M9NVZ  
None ..... N (Example) H7CN

\* Since there are other applicable auto switches than listed above, refer to page 279 for details.

\* Solid state auto switches marked with "C" are produced upon receipt of order.

\* The D-A9□/M9□/A7□/A80□/F7□/J7□ auto switches are shipped together, but not assembled. (For band mounting, only the auto switch mounting brackets are assembled before shipment.)



**Symbol**

Double acting, Single rod, Rubber bumper

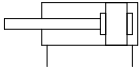

**Mounting Brackets/Part No.**

Mounting bracket	Bore size (mm)	
	10	16
Foot	CJ-L010C	CJ-L016C
Flange	CJ-F010C	CJ-F016C
T-bracket*	CJ-T010C	CJ-T016C

\* A T-bracket is used with double clevis (D).

**Specifications**

Bore size (mm)	10	16
Action	Double acting, Single rod	
Fluid	Air	
Proof pressure	1.05 MPa	
Maximum operating pressure	0.7 MPa	
Ambient and fluid temperature	Without auto switch: -10°C to 70°C With auto switch: -10°C to 60°C (No freezing)	
Cushion	Rubber bumper (Standard equipment)	
Lubrication	Not required (Non-lube)	
Stroke length tolerance	+1.5 0	
Piston speed	1 to 300 mm/s	
Allowable kinetic energy	ø10	0.035 J
	ø16	0.090 J

**Minimum Operating Pressure**

Bore size (mm)	10	16
Minimum operating pressure	0.06	

Unit: MPa

**Standard Strokes**

Bore size (mm)	Standard stroke (mm)
10	15, 30, 45, 60, 75, 100, 125, 150
16	15, 30, 45, 60, 75, 100, 125, 150, 175, 200

Note 1) Manufacture of intermediate strokes at 1 mm intervals is possible. (Spacers are not used.)

Note 2) Applicable strokes should be confirmed according to the usage. For details, refer to "Air Cylinders Model Selection" in the **Web Catalog**.

**Mounting and Accessories** / For details about accessories, refer to page 271.

●---Mounted on the product. ○---Please order these separately. △---Order separately.

	Mounting	Basic	Foot	Flange	Double*1 clevis
Standard	Mounting nut	●	●	●	—
	Rod end nut	●	●	●	●
	Clevis pin	—	—	—	●
Option	Single knuckle joint	○	○	○	○
	Double knuckle joint*1	○	○	○	○
	Double knuckle joint (With one-touch connecting pin)	△	△	△	△
	Rod end cap (Flat/Round type)	○	○	○	○
	T-bracket	—	—	—	○

\*1 A pin and retaining rings are included with double clevis and/or double knuckle joint.

\*2 Stainless steel mounting brackets and accessories are also available.

Refer to page 272 for details.

**Ordering Example of Cylinder Assembly**

Cylinder model: **CDJ2XD16-60Z-NW-M9BW-B**

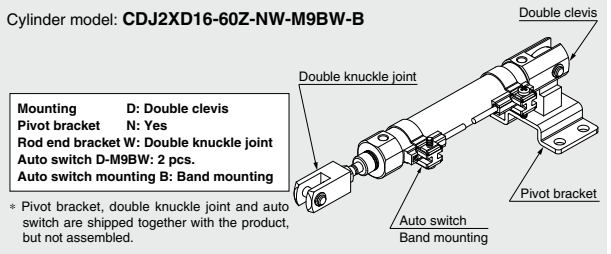

**Mounting** D: Double clevis  
**Pivot bracket** N: Yes  
**Rod end bracket** W: Double knuckle joint  
**Auto switch** D-M9BW: 2 pcs.  
**Auto switch mounting** B: Band mounting

\* Pivot bracket, double knuckle joint and auto switch are shipped together with the product, but not assembled.

## ⚠ Precautions

Be sure to read this before handling the products.

Refer to page 9 for safety instructions and pages 10 to 19 for actuator and auto switch precautions.

### Mounting

#### ⚠ Caution

- During installation, secure the rod cover and tighten by applying an appropriate tightening force to the retaining nut or to the rod cover body.  
If the head cover is secured or the head cover is tightened, the cover could rotate, leading to the deviation.
- Tighten the retaining screws to an appropriate tightening torque within the range given below. Apply a Loctite® (no. 242 Blue) for mounting thread.

Bore size (mm)	Proper tightening torque for mounting thread (N·m) (Tightening torque for mounting nut)
10	3.0 to 3.2
16	5.4 to 5.9

- To remove and install the retaining ring for the knuckle pin or the clevis pin, use an appropriate pair of pliers (tool for installing a type C retaining ring).  
Especially with ø10, use ultra thin pliers.
- In the case of auto switch rail mounting type, do not remove the rail that is mounted.  
Because retaining screws extend into the cylinder, this could lead to an air leak.

## Weights

		(g)	
Bore size (mm)		10	16
Basic weight (When the stroke is zero)	Basic	22	46
	Axial piping	22	46
	Double clevis (including clevis pin)	24	54
	Head-side bossed	23	48
Additional weight per 15 mm of stroke		4	7
Mounting bracket weight	Single foot	8	25
	Double foot	16	50
	Rod flange	5	13
	Head flange	5	13
Accessories	Single knuckle joint	17	23
	Double knuckle joint (including knuckle pin)	25	21
	Double knuckle joint (With one-touch connecting pin)	26	22
	Rod end cap (Flat type)	1	2
	Rod end cap (Round type)	1	2
	T-bracket	32	50

\* Mounting nut and rod end nut are included in the basic weight.  
Note) Mounting nut is not included in the basic weight for the double clevis.

Calculation: Example) **CJ2XL10-45Z**  
 ● Basic weight.....22 (ø10)  
 ● Additional weight.....4/15 stroke  
 ● Cylinder stroke.....45 stroke  
 ● Mounting bracket weight.....8 (Axial foot)  
 $22 + 4/15 \times 45 + 8 = 42 \text{ g}$

## Dimensions

### Basic (B)

CJ2XB **Bore size** – **Stroke** **Head cover port location** **Z**

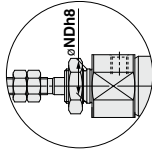

Section Y detail

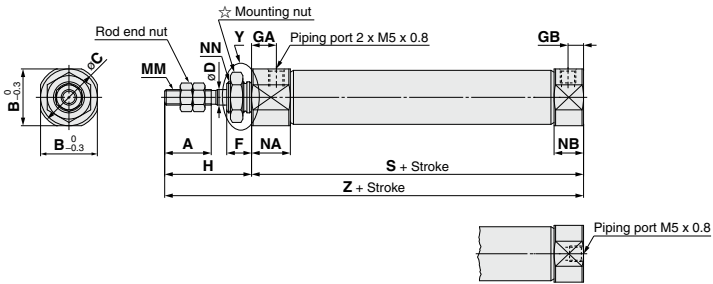

Head cover port location  
Axial location (R)

\* The overall cylinder length does not change.

☆ Refer to page 271 for details of the mounting nut.

Bore size	A	B	C	D	F	GA	GB	H	MM	NA	NB	NDh8	NN	S	Z
10	15	12	14	4	8	8	5	28	M4 x 0.7	12.5	9.5	$8^{0}_{-0.022}$	M8 x 1.0	46	74
16	15	18.3	20	5	8	8	5	28	M5 x 0.8	12.5	9.5	$10^{0}_{-0.022}$	M10 x 1.0	47	75

(mm)

### Single foot (L)

CJ2XL **Bore size** – **Stroke** **Head cover port location** **Z**

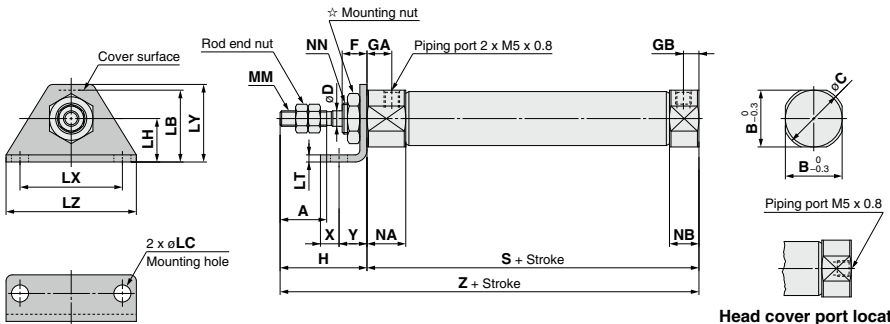

Head cover port location  
Axial location (R)

\* The overall cylinder length does not change.

☆ Refer to page 271 for details of the mounting nut.

Bore size	A	B	C	D	F	GA	GB	H	LB	LC	LH	LT	LX	LY	LZ	MM	NA	NB	NN	S	X	Y	Z
10	15	12	14	4	8	8	5	28	15	4.5	9	1.6	24	16.5	32	M4 x 0.7	12.5	9.5	M8 x 1.0	46	5	7	74
16	15	18.3	20	5	8	8	5	28	23	5.5	14	2.3	33	25	42	M5 x 0.8	12.5	9.5	M10 x 1.0	47	6	9	75

(mm)

# CJ2X Series

## Dimensions

### Double foot (M)

CJ2XM Bore size – Stroke Z

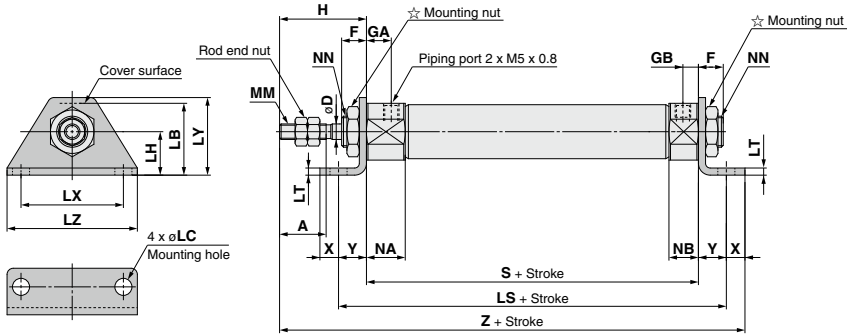

☆ Refer to page 271 for details of the mounting nut.

Bore size	A	D	F	GA	GB	H	LB	LC	LH	LS	LT	LX	LY	LZ	MM	NA	NB	NN	S	X	Y	Z
10	15	4	8	8	5	28	15	4.5	9	60	1.6	24	16.5	32	M4 x 0.7	12.5	9.5	M8 x 1.0	46	5	7	86
16	15	5	8	8	5	28	23	5.5	14	65	2.3	33	25	42	M5 x 0.8	12.5	9.5	M10 x 1.0	47	6	9	90

(mm)

### Rod flange (F)

CJ2XF Bore size – Stroke Head cover port location Z

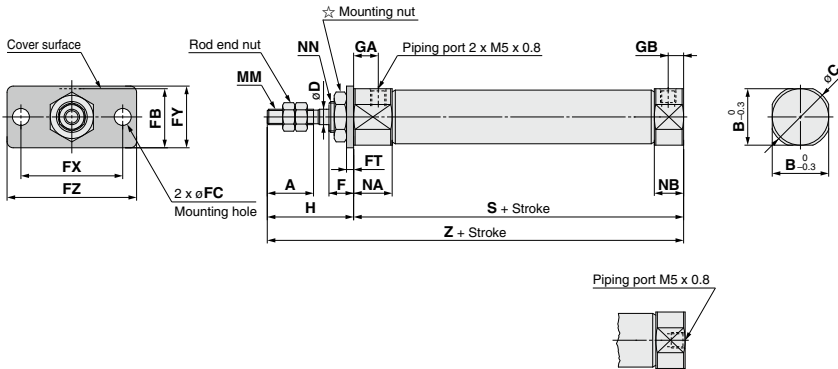

### Head cover port location Axial location (R)

☆ Refer to page 271 for details of the mounting nut.

\* The overall cylinder length does not change.

Bore size	A	B	C	D	F	FB	FC	FT	FX	FY	FZ	GA	GB	H	MM	NA	NB	NN	S	Z
10	15	12	14	4	8	13	4.5	1.6	24	14	32	8	5	28	M4 x 0.7	12.5	9.5	M8 x 1.0	46	74
16	15	18.3	20	5	8	19	5.5	2.3	33	20	42	8	5	28	M5 x 0.8	12.5	9.5	M10 x 1.0	47	75

(mm)

## Dimensions

### Head flange (G)

CJ2XG Bore size – Stroke Z

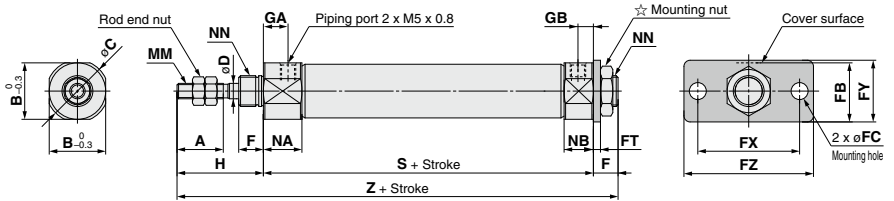

☆ Refer to page 271 for details of the mounting nut.

Bore size	A	B	C	D	F	FB	FC	FT	FX	FY	FZ	GA	GB	H	MM	NA	NB	NN	S	Z
10	15	12	14	4	8	13	4.5	1.6	24	14	32	8	5	28	M4 x 0.7	12.5	9.5	M8 x 1.0	46	82
16	15	18.3	20	5	8	19	5.5	2.3	33	20	42	8	5	28	M5 x 0.8	12.5	9.5	M10 x 1.0	47	83

### Double clevis (D)

CJ2XD Bore size – Stroke Z

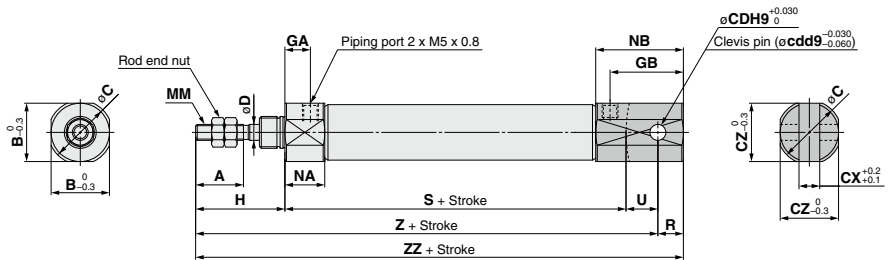

\* A clevis pin and retaining rings are included.

Bore size	A	B	C	CD(ed)	CX	CZ	D	GA	GB	H	MM	NA	NB	R	S	U	Z	ZZ
10	15	12	14	3.3	3.2	12	4	8	18	28	M4 x 0.7	12.5	22.5	5	46	8	82	87
16	15	18.3	20	5	6.5	18.3	5	8	23	28	M5 x 0.8	12.5	27.5	8	47	10	85	93

# CJ2X Series

## Dimensions

### Double-side bossed (E)

CJ2XE Bore size – Stroke Z

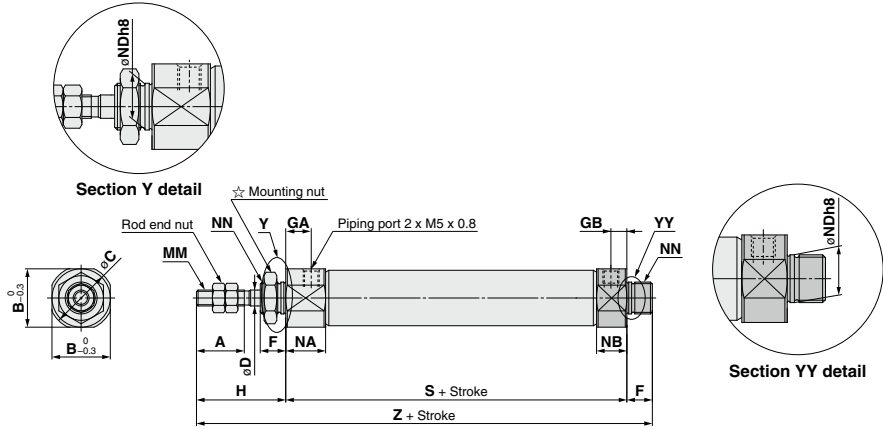

☆ Refer to page 271 for details of the mounting nut.

Bore size	A	B	C	D	F	GA	GB	H	MM	NA	NB	NDh8	NN	S	Z
10	15	12	14	4	8	8	5	28	M4 x 0.7	12.5	9.5	8 <sup>0</sup> <sub>-0.022</sub>	M8 x 1.0	46	82
16	15	18.3	20	5	8	8	5	28	M5 x 0.8	12.5	9.5	10 <sup>0</sup> <sub>-0.022</sub>	M10 x 1.0	47	83



# CJ2X Series

## Dimensions of Accessories (options)

### Single Knuckle Joint Material: Rolled steel

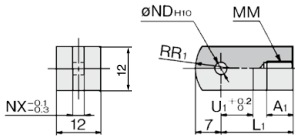

(mm)

Part no.	Applicable bore size	A <sub>1</sub>	L <sub>1</sub>	MM	ND <sub>H10</sub>	NX	R <sub>1</sub>	U <sub>1</sub>
I-J010C	10	8	21	M4 x 0.7	3.3 <sup>+0.048</sup> / <sub>0</sub>	3.1	8	9
I-J016C	16	8	25	M5 x 0.8	5 <sup>+0.048</sup> / <sub>0</sub>	6.4	12	14

### Double Knuckle Joint Material: Rolled steel

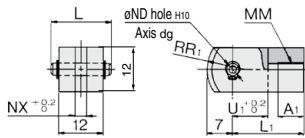

(mm)

Part no.	Applicable bore size	A <sub>1</sub>	L	L <sub>1</sub>	MM
Y-J010C	10	8	15.2	21	M4 x 0.7
Y-J016C	16	11	16.6	21	M5 x 0.8

Part no.	ND <sub>d9</sub>	ND <sub>H10</sub>	NX	R <sub>1</sub>	U <sub>1</sub>
Y-J010C	3.3 <sup>+0.030</sup> / <sub>-0.060</sub>	3.3 <sup>+0.048</sup> / <sub>0</sub>	3.2	8	10
Y-J016C	5 <sup>+0.030</sup> / <sub>-0.060</sub>	5 <sup>+0.048</sup> / <sub>0</sub>	6.5	12	10

\* A knuckle pin and retaining rings are included.

### Knuckle Pin Material: Stainless steel

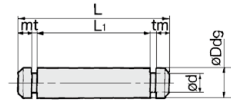

(mm)

Part no.	Applicable bore size	Dd9	d	L	L <sub>1</sub>	m	t	Included retaining ring
CD-J010	10	3.3 <sup>+0.030</sup> / <sub>-0.060</sub>	3	15.2	12.2	1.2	0.3	Type C 3.2
IY-J015	16	5 <sup>+0.030</sup> / <sub>-0.060</sub>	4.8	16.6	12.2	1.5	0.7	Type C 3.5

\* For ø10, a clevis pin is diverted.

\* Retaining rings are included with a knuckle pin.

### Double Knuckle Joint (With One-touch Connecting Pin)

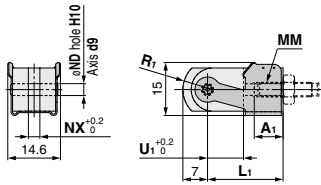

(mm)

Part no.	Applicable bore size	A <sub>1</sub>	L <sub>1</sub>	MM	ND <sub>d9</sub>	ND <sub>H10</sub>	NX	R <sub>1</sub>	U <sub>1</sub>
Y-J10	10	8	21	M4 x 0.7	3.3 <sup>+0.030</sup> / <sub>-0.060</sub>	3.3 <sup>+0.048</sup> / <sub>0</sub>	3.2	8	10
Y-J16	16	11	21	M5 x 0.8	5 <sup>+0.030</sup> / <sub>-0.060</sub>	5 <sup>+0.048</sup> / <sub>0</sub>	6.5	12	10

### One-touch Connecting Pin for Double Knuckle Joint Material: Stainless steel

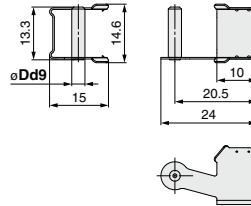

(mm)

Part no.	Applicable bore size	Dd9
IY-J10	10	3.3 <sup>+0.030</sup> / <sub>-0.060</sub>
IY-J16	16	5 <sup>+0.030</sup> / <sub>-0.060</sub>

### Mounting Nut Material: Carbon steel

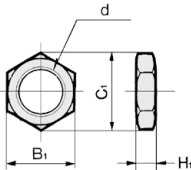

(mm)

Part no.	Applicable bore size	B <sub>1</sub>	C <sub>1</sub>	d	H <sub>1</sub>
SNJ-010C	10	11	12.7	M8 x 1.0	4
SNJ-016C	16	14	16.2	M10 x 1.0	4

### Rod End Nut Material: Carbon steel

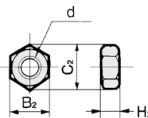

(mm)

Part no.	Applicable bore size	B <sub>2</sub>	C <sub>2</sub>	d	H <sub>2</sub>
NTJ-010C	10	7	8.1	M4 x 0.7	3.2
NTJ-015C	16	8	9.2	M5 x 0.8	4

# CJ2X Series

## Pivot Bracket (T-bracket)

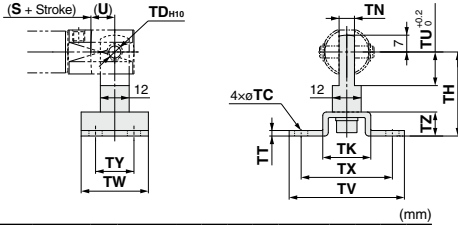

Part no.	Applicable bore size	TC	TD <sub>H10</sub>	TH	TK	TN	TT	TU	TV	TW	TX	TY	TZ
CJ-T010C	10	4.5	3.3 <sup>+0.048</sup> <sub>0</sub>	29	18	3.1	2	9	40	22	32	12	8
CJ-T016C	16	5.5	5 <sup>+0.048</sup> <sub>0</sub>	35	20	6.4	2.3	14	48	28	38	16	10

\* A T-bracket includes a T-bracket base, single knuckle joint, hexagon socket head bolt and spring washer.

\* For dimensions of (U) and (S + Stroke), refer to the double clevis drawing on page 269.

## Clevis Pin

Material: Stainless steel

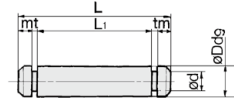

Part no.	Applicable bore size	Dd9	d	L	L <sub>1</sub>	m	t	Included retaining ring
CD-J010	10	3.3 <sup>-0.030</sup> <sub>-0.060</sub>	3	15.2	12.2	1.2	0.3	Type C 3.2
CD-Z015	16	5 <sup>-0.030</sup> <sub>-0.060</sub>	4.8	22.7	18.3	1.5	0.7	Type C 5

\* Retaining rings are included with a clevis pin.

## One-touch Connecting Pin for Double Clevis

Material: Stainless steel

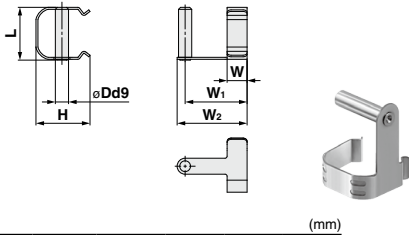

Part no.	Applicable bore size	Dd9	H	L	W
CD-J10	10	3.3 <sup>-0.030</sup> <sub>-0.060</sub>	13.4	13.2	4
CD-J16	16	5 <sup>-0.030</sup> <sub>-0.060</sub>	18.2	19.5	5

Part no.	W <sub>1</sub>	W <sub>2</sub>	Note
CD-J10	12	15	Cannot be mounted on cylinders with air cushion, or rail mounting type auto switches.
CD-J16	15	18	

\* Please pay attention to the applicable cylinder.

## Rod End Cap

Material: Polycacetal

Flat type/CJ-CF□□□□      Round type/CJ-CR□□□□

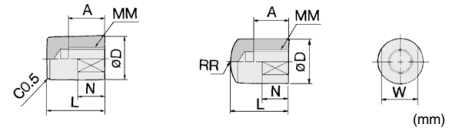

Part no.	Applicable bore size	A	D	L	MM	N	R	W	
CJ-CF010	CJ-CR010	10	8	10	13	M4 x 0.7	6	10	8
CJ-CF016	CJ-CR016	16	10	12	15	M5 x 0.8	7	12	10

## Mounting Brackets, Rod End Brackets, and Nut Material: Stainless Steel

Part No. (Dimensions: Same as standard type)

Bore size (mm)	Foot	Flange	Single knuckle joint	Double knuckle joint*	Mounting nut	Rod end nut
10	—	—	I-J010SUS	Y-J010SUS	—	NTJ-010SUS
16	CJ-L016SUS	CJ-F016SUS	I-J016SUS	Y-J016SUS	SNJ-016SUS	NTJ-015SUS

\* A knuckle pin and retaining rings are shipped together.

**Precautions**

**Assembly Procedures**

**1. Double Clevis (With One-touch Connecting Pin) (CD-J□)**

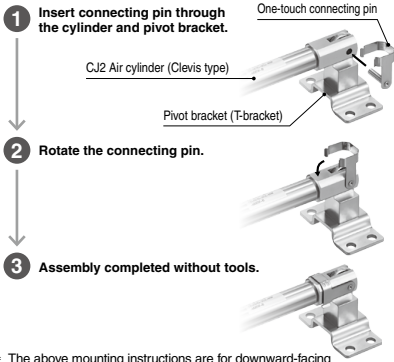

\* The above mounting instructions are for downward-facing ports. Refer to the following for upward-facing ports.

**2. Double Knuckle Joint (With One-touch Connecting Pin) (IV-J□)**

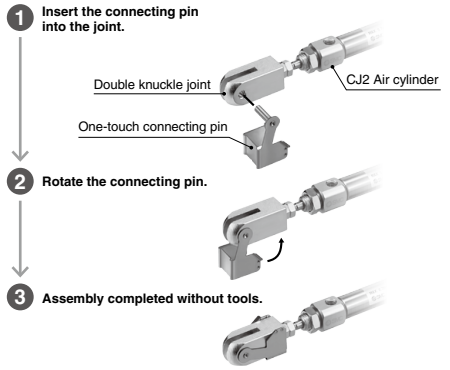

**How to Mount the Double Clevis (With One-touch Connecting Pin)**

When connecting a double clevis cylinder to a pivot bracket (T-bracket), it is recommended that the pivot bracket (T-bracket) and the cylinder be connected with the one-touch connecting pin first, before fastening the pivot bracket.

When connecting the cylinder after the pivot bracket (T-bracket) has been fastened, mount the cylinder according to the following procedure.

**⚠ Warning**

For assembling the clevis type to the pivot bracket, refer to the figure below.

1. Insert the double clevis (One-touch connecting pin) from the direction in the figure.

When port is facing upward

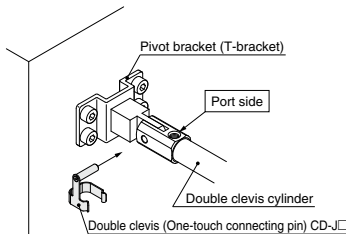

When port is facing downward

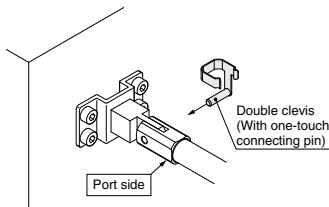

**⚠ Warning**

\* Perform the mounting within the following range.

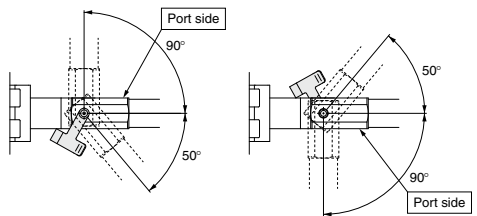

2. Push the one-touch connecting pin into the cylinder body (Double clevis) until it clicks and is firmly fastened.

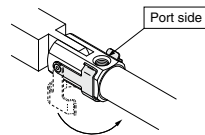

\* Attach the double knuckle joint within 180° (±90° from center). Other mounting methods are the same as the above.

# CJ2X Series Auto Switch Mounting

## Auto Switch Proper Mounting Position (Detection at stroke end) and Its Mounting Height

### Solid state auto switch

#### <Band mounting>

D-M9□  
D-M9□W  
D-M9□A

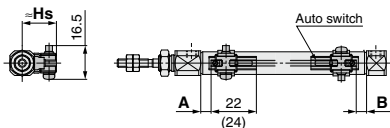

( ) : Dimension of the D-M9□A  
A and B are the dimensions from the end of the head cover/rod cover to the end of the auto switch.

D-M9□V  
D-M9□MV  
D-M9□AV

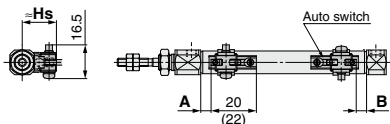

( ) : Dimension of the D-M9□AV  
A and B are the dimensions from the end of the head cover/rod cover to the end of the auto switch.

D-H7□  
D-H7□W  
D-H7BA  
D-H7NF  
D-H7C

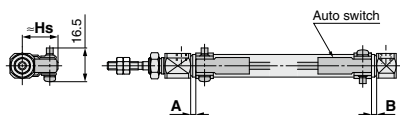

### Reed auto switch

#### <Band mounting>

D-A9□

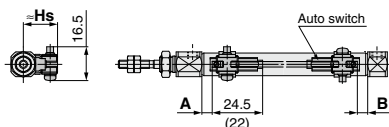

( ) : Dimension of the D-A96  
A and B are the dimensions from the end of the head cover/rod cover to the end of the auto switch.

D-A9□V

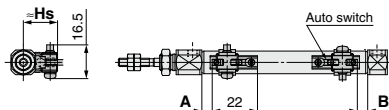

A and B are the dimensions from the end of the head cover/rod cover to the end of the auto switch.

D-C7□/C80  
D-C73C□/C80C

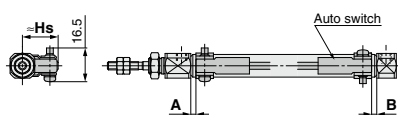

**Auto Switch Proper Mounting Position (Detection at stroke end) and Its Mounting Height**

<Rail mounting>

D-M9□  
D-M9□W  
D-M9□A

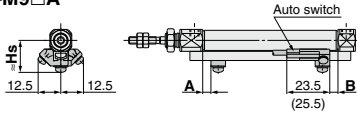

( ) : Dimension of the D-M9□A

D-M9□V  
D-M9□WV  
D-M9□AV

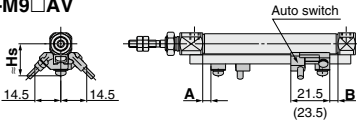

( ) : Dimension of the D-M9□AV

D-F7□/J79  
D-F7□W/J79W  
D-F79F/F7BA

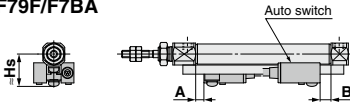

D-F7□V/F7□WV  
D-F7BAV  
D-J79C

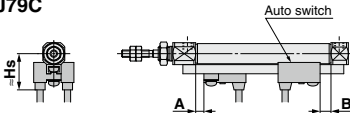

<Rail mounting>

D-A9□

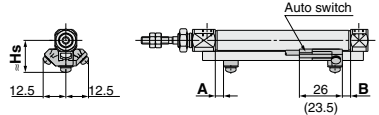

( ) : Dimension of the D-A96

D-A9□V

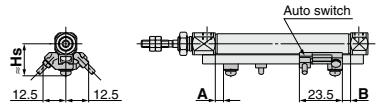

D-A7□/A80  
D-A73C/A80C  
D-A79W

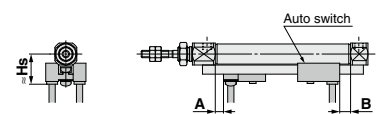

D-A7□H/A80H

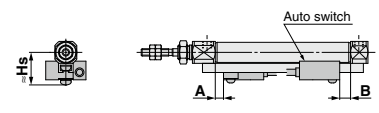

## Auto Switch Proper Mounting Position (Detection at stroke end) and Its Mounting Height

### Auto Switch Proper Mounting Position

Auto switch model		Band mounting							
		D-M9□ D-M9□V D-M9□W D-M9□WV D-M9□A D-M9□AV		D-A9□ D-A9□V		D-C7□ D-C90 D-C73C D-C80C		D-H7□ D-H7C D-H7NF D-H7□W D-H7BA	
Bore size		A	B	A	B	A	B	A	B
10		(5) 6	(5) 6	(1) 2	(1) 2	2.5	2.5	1.5	1.5
16		(5.5) 6.5	(5.5) 6.5	(1.5) 2.5	(1.5) 2.5	3	3	2	2

\* The values in ( ) are measured from the end of the auto switch mounting bracket.

Auto switch model		Rail mounting											
		D-M9□ D-M9□V D-M9□W D-M9□WV D-M9□A D-M9□AV		D-A9□ D-A9□V		D-A7□ D-A80		D-A7□H/A80H D-A73C/A80C D-F7□/J79 D-F7□W/J79W D-F7□V/F7□WV D-F79F D-J79C D-F7BA D-F7BAV		D-F7NT		D-A79W	
Bore size		A	B	A	B	A	B	A	B	A	B	A	B
10		4.5	4.5	0.5	0.5	3	3	3.5	3.5	8.5	8.5	0.5	0.5
16		5	5	1	1	3.5	3.5	4	4	9	9	1	1

\* Adjust the auto switch after confirming the operating condition in the actual setting.

### Auto Switch Mounting Height

Auto switch model		Band mounting											
		D-M9□ D-M9□W D-M9□A D-A9□		D-M9□V D-M9□WV D-M9□AV D-A9□V		D-C7□C80 D-H7□H7□W D-H7NF D-H7BA		D-C73C D-C80C		D-H7C		D-A7□ D-A80	
Bore size		Hs		Hs		Hs		Hs		Hs		Hs	
10		17		18		17		19.5		20		16.5	
16		20.5		21		20.5		23		23.5		19.5	

Auto switch model		Rail mounting											
		D-M9□ D-M9□V D-M9□W D-M9□WV D-M9□A D-M9□AV D-A9□ D-A9□V		D-A7□H/A80H D-F7□/J79 D-F7□W/J79W D-F7BA/F79F D-F7NT		D-A73C D-A80C		D-F7□V D-F7□WV D-F7BAV		D-J79C		D-A79W	
Bore size		Hs		Hs		Hs		Hs		Hs		Hs	
10		17.5		17.5		23.5		20		23		19	
16		21		20.5		26.5		23		26		22	

**Minimum Stroke for Auto Switch Mounting**

		(mm)				
Auto switch mounting	Auto switch model	Number of auto switches				
		With 1 pc.	With 2 pcs.		With n pcs. (n: Number of auto switches)	
			Different surfaces	Same surface	Different surfaces	Same surface
Band mounting	D-M9□ D-M9□W D-M9□A D-A9□	10	15 Note 1)	45 Note 1)	$15 + 35 \frac{(n-2)}{2}$ (n = 2, 4, 6... ) Note 3)	45 + 15 (n - 2) (n = 2, 3, 4, 5...)
	D-M9□V	5	15 Note 1)	35	$15 + 35 \frac{(n-2)}{2}$ (n = 2, 4, 6... ) Note 3)	35 + 25 (n - 2) (n = 2, 3, 4, 5...)
	D-M9□WV D-M9□AV	10	15 Note 1)	35	$15 + 35 \frac{(n-2)}{2}$ (n = 2, 4, 6... ) Note 3)	35 + 25 (n - 2) (n = 2, 3, 4, 5...)
	D-A9□V	5	10	35	$10 + 35 \frac{(n-2)}{2}$ (n = 2, 4, 6... ) Note 3)	35 + 25 (n - 2) (n = 2, 3, 4, 5...)
	D-C7□ D-C80	10	15	50	$15 + 40 \frac{(n-2)}{2}$ (n = 2, 4, 6... ) Note 3)	50 + 20 (n - 2) (n = 2, 3, 4, 5...)
	D-H7□/H7□W D-H7BA D-H7NF	10	15	60	$15 + 45 \frac{(n-2)}{2}$ (n = 2, 4, 6... ) Note 3)	60 + 22.5 (n - 2) (n = 2, 3, 4, 5...)
	D-C73C D-C80C D-H7C	10	15	65	$15 + 50 \frac{(n-2)}{2}$ (n = 2, 4, 6... ) Note 3)	50 + 27.5 (n - 2) (n = 2, 3, 4, 5...)
Rail mounting	D-M9□V	5	—	5	—	10 + 10 (n - 2) (n = 4, 6... ) Note 4)
	D-A9□V	5	—	10	—	10 + 15 (n - 2) (n = 4, 6... ) Note 4)
	D-M9□ D-A9□	10	—	10	—	15 + 15 (n - 2) (n = 4, 6... ) Note 4)
	D-M9□WV D-M9□AV	10	—	15	—	15 + 15 (n - 2) (n = 4, 6... ) Note 4)
	D-M9□W	15	—	15	—	20 + 15 (n - 2) (n = 4, 6... ) Note 4)
	D-M9□A	15	—	20	—	20 + 15 (n - 2) (n = 4, 6... ) Note 4)
	D-A7□/A80 D-A7□H/A80H D-A73C/A80C	5	—	10	—	15 + 10 (n - 2) (n = 4, 6... ) Note 4)
	D-A7□H D-A80H	5	—	10	—	15 + 15 (n - 2) (n = 4, 6... ) Note 4)
	D-A79W	10	—	15	—	10 + 15 (n - 2) (n = 4, 6... ) Note 4)
	D-F7□ D-J79	5	—	5	—	15 + 15 (n - 2) (n = 4, 6... ) Note 4)
	D-F7□V D-J79C	5	—	5	—	10 + 10 (n - 2) (n = 4, 6... ) Note 4)
	D-F7□W/J79W D-F7BA/F79F/F7NT	10	—	15	—	15 + 20 (n - 2) (n = 4, 6... ) Note 4)
	D-F7□WV D-F7BAV	10	—	15	—	10 + 15 (n - 2) (n = 4, 6... ) Note 4)

Note 3) When "n" is an odd number, an even number that is one larger than this odd number is used for the calculation.

Note 4) When "n" is an odd number, an even number that is one larger than this odd number is used for the calculation.

However, the minimum even number is 4. So, 4 is used for the calculation when "n" is 1 to 3.

Note 1) Auto switch mounting

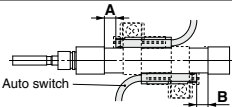
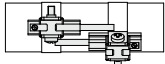
Auto switch model	With 2 auto switches	
	Different surfaces Note 1)	Same surface Note 1)
	 <p>The proper auto switch mounting position is 5.5 mm inward from the switch holder edge. The above A and B indicate values for band mounting in the table of page 276.</p>	 <p>The auto switch is mounted by slightly displacing it in a direction (cylinder tube circumferential exterior) so that the auto switch and lead wire do not interfere with each other.</p>
D-M9□/M9□W/M9□A	Less than 20 stroke Note 2)	Less than 55 stroke Note 2)
D-A90/A93	—	Less than 50 stroke Note 2)

Note 2) Minimum stroke for auto switch mounting in types other than those mentioned in Note 1.

## Operating Range

Auto switch model	Bore size (mm)		
	10	16	
Band mounting	D-M9□/M9□V D-M9□W/M9□WV D-M9□A/M9□AV	2.5	3
	D-A9□	6	7
	D-C7□/C80/C73C/C80C	7	7
	D-H7□/H7□W D-H7BA/H7NF	4	4
	D-H7C	8	9
	Rail mounting	D-M9□/M9□V D-M9□W/M9□WV D-M9□A/M9□AV	3
D-A9□/A9□V		6	6.5
D-A7□/A80/A7H/A80H D-A73C/A80C		8	9
D-A79W		11	13
D-F7□/J79/F7□W/J79W D-F7□V/F7□WV/F79F D-J79C/F7BA/F7BAV D-F7NT		5	5

\* Values which include hysteresis are for guideline purposes only, they are not a guarantee (assuming approximately ±30% dispersion) and may change substantially depending on the ambient environment.

## Auto Switch Mounting Brackets/Part No.

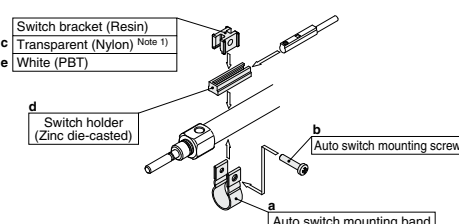
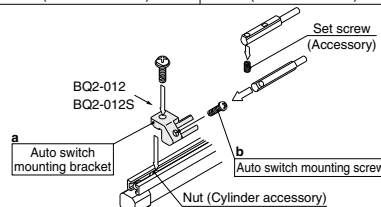
Auto switch mounting	Auto switch model	Bore size (mm)	
		10	16
Band mounting	D-M9□ D-M9□V D-M9□W D-M9□WV D-A9□ D-A9□V	BJ6-010 (A set of a, b, c, d)	BJ6-016 (A set of a, b, c, d)
	D-M9□A <sup>Note 2)</sup> D-M9□AV <sup>Note 2)</sup>	BJ6-010S (A set of a, b, d, e)	BJ6-016S (A set of a, b, d, e)
Band mounting			
Band mounting	D-C7□/C80 D-C73C/C80C D-H7□/H7□W D-H7BA/H7NF	BJ2-010 (A set of band and screw)	BJ2-016 (A set of band and screw)
Rail mounting <sup>Note 4)</sup>	D-M9□ D-M9□V D-M9□W D-M9□WV D-M9□A <sup>Note 5)</sup> D-M9□AV <sup>Note 5)</sup> D-A9□ D-A9□V	BQ2-012(S) (A set of a and b)	BQ2-012(S) (A set of a and b)
			

Note 1) Since the switch bracket (made from nylon) are affected in an environment where alcohol, chloroform, methylamines, hydrochloric acid or sulfuric acid is splashed over, so it cannot be used. Please contact SMC regarding other chemicals.

Note 2) When the indicator LED for mounting the switch bracket. As the indicator LED is projected from the switch unit, indicator LED may be damaged if the switch bracket is fixed on the indicator LED.

Note 3) When the cylinder is shipped, the auto switch mounting bracket and the auto switch will be included.

Note 4) For the D-M9□A(V), order the BQ2-012S, which uses stainless steel mounting screws.

### Band Mounting Brackets Set Part No.

Set part no.	Contents
BJ2-□□□	• Auto switch mounting band (a) • Auto switch mounting screw (b)
BJ4-1	• Switch bracket (White/PBT) (e) • Switch holder (d)
BJ5-1	• Switch bracket (Transparent/Nylon) (c) • Switch holder (d)

### [Stainless Steel Mounting Screw]

The following stainless steel mounting screw kit is available. Use it in accordance with the operating environment. (Since the auto switch mounting bracket is not included, order it separately.)

BBA4: For D-C7/C8/H7 types

Note 5) Refer to page 1440 for details on the BBA4.

When the D-H7BA type auto switch is shipped independently, the BBA4 is attached.



**Other than the applicable auto switches listed in “How to Order”, the following auto switches are mountable.**

Refer to pages 1341 to 1435 for the detailed specifications.

Type	Mounting	Model	Electrical entry	Features	
Solid state	Band mounting	D-H7A1/H7A2/H7B	Grommet (In-line)	—	
		D-H7NW/H7PW/H7BW		Diagnostic indication (2-color indicator)	
	Rail mounting	D-F79/F7P/J79		Grommet (Perpendicular)	—
		D-F79W/F7PW/J79W			Diagnostic indication (2-color indicator)
		D-F7NV/F7PV/F7BV	Grommet (Perpendicular)	—	
		D-F7NWV/F7BWV		Diagnostic indication (2-color indicator)	
Reed	Band mounting	D-C73/C76	Grommet (In-line)	—	
		D-C80		Without indicator light	
	Rail mounting	D-A73H/A76H		Grommet (Perpendicular)	—
		D-A80H			Without indicator light
		D-A73	Grommet (Perpendicular)	—	
		D-A80		Without indicator light	

\* With pre-wired connector is also available for solid state auto switches. For details, refer to pages 1410 and 1411.

\* Normally closed (NC = b contact) solid state auto switches (D-M9□E(V)) are also available. For details, refer to page 1360.

# Low Speed Cylinder

## Double Acting, Single Rod

# CM2X Series

ø20, ø25, ø32, ø40

RoHS

### How to Order

**Mounting**

B	Basic (Double-side bodded)
L	Axial foot
F	Rod flange
G	Head flange
C	Single clevis
D	Double clevis
U	Rod trunnion
T	Head trunnion
E	Integrated clevis
V	Integrated clevis (90°)
BZ	Boss-cut/Basic
FZ	Boss-cut/Rod flange
UZ	Boss-cut/Rod trunnion

**Cylinder stroke (mm)**  
Refer to "Standard Strokes" on page 281.

**Rod end thread**

Nil	Male rod end
F	Female rod end

**Pivot bracket**

Nil	None
N	Pivot bracket is shipped together with the product.

\* Only for C, T, U, E, V, UZ mounting types  
\* Pivot bracket is shipped together with the product, but not assembled.

**Made to Order**  
Refer to page 281 for details.

**With auto switch**  
**Low speed cylinder**

**Port thread type**

Nil	Rc
TN	NPT
TF	G

**Bore size**

20	20 mm
25	25 mm
32	32 mm
40	40 mm

**Auto switch**

Nil	Without auto switch
N	With auto switch

### Built-in Magnet Cylinder Model

If a built-in magnet cylinder without an auto switch is required, there is no need to enter the symbol for the auto switch. (Example) CDM2XF32-100Z

### Applicable Auto Switches/Refer to pages 1341 to 1435 for further information on auto switches.

Type	Special function	Electrical entry	Indicator light	Wiring (Output)	Load voltage		Auto switch model		Lead wire length (m)					Pre-wired connector	Applicable load
					DC	AC	Perpendicular	In-line	0.5 (Nil)	1 (M)	3 (L)	5 (Z)	None (N)		
Solid state auto switch		Grommet	No	3-wire (NPN)	5 V, 12 V		M9NV	M9N	●	●	○	○	○	IC circuit	Relay, PLC
				3-wire (PNP)			M9PV	M9P	●	●	○	○			
		Connector	2-wire	12 V		M9BV	M9B	●	●	○	○	IC circuit			
			Terminal conduit	2-wire	12 V		H7C	●	●	●	●				
	Diagnostic indication (2-color indicator)	Grommet	Yes	3-wire (NPN)	5 V, 12 V	24 V		M9NVV	M9NV	●	●	○	○	IC circuit	
				3-wire (PNP)	5 V, 12 V			M9PVV	M9PV	●	●	○	○		
		Grommet	Yes	3-wire (NPN)	5 V, 12 V		M9BWW	M9BW	●	●	○	○	IC circuit		
				3-wire (PNP)	5 V, 12 V		M9BVA*1	M9BA*1	○	○	○	○			
		With diagnostic output (2-color indicator)	Grommet	Yes	4-wire (NPN)	5 V, 12 V		M9BAV*1	M9BA*1	○	○	○	○	IC circuit	
					4-wire (PNP)	5 V, 12 V		M9BAV*1	M9BA*1	○	○	○	○		
Reed auto switch		Grommet	No	2-wire	24 V		A96V	A96	●	●	●	●	IC circuit		
							A93V*2	A93	●	●	●	●			
		Connector	No	2-wire	24 V			A90V	A90	●	●	●	●	IC circuit	
								B54	B54	●	●	●	●		
		Terminal conduit	No	2-wire	24 V			C73C	C73C	●	●	●	●	IC circuit	
								C80C	C80C	●	●	●	●		
		DIN terminal	Yes	2-wire	24 V			A33A	A33A	—	—	—	—	PLC	
								A34A	A34A	—	—	—	—		
		Diagnostic indication (2-color indicator)	Grommet	Yes	2-wire	24 V			A44A	A44A	—	—	—	—	Relay, PLC
									B59W	B59W	●	●	—	—	

\*1 Water resistant type auto switches can be mounted on the above models, but in such case SMC cannot guarantee water resistance. Please consult with SMC regarding water resistant types with the above model numbers.

\*2 1 m type lead wire is only applicable to D-A93.

\* Lead wire length symbols: 0.5 m ..... Nil (Example) M9NV  
1 m ..... M (Example) M9NVW  
3 m ..... L (Example) M9NVL  
5 m ..... Z (Example) M9NVZ  
None ..... N (Example) H7CN

\* Solid state auto switches marked with "○" are produced upon receipt of order.  
\* Do not indicate suffix "N" for no lead wire on the D-A93/A/A44A/G39A/K39A models.

\* Since there are other applicable auto switches than listed above, refer to page 297 for details.

\* For details about auto switches with pre-wired connector, refer to pages 1410 and 1411.

\* The D-A93□/M93□ auto switches are shipped together, (but not assembled). (However, only the auto switch mounting brackets are assembled before shipment.)

\* The D-C7□/C80□/H7□ auto switches are assembled before shipment.



**Symbol**

Double acting, Single rod, Rubber bumper

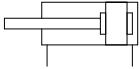

**Standard Strokes**

Bore size (mm)	Standard stroke (mm)
20	
25	25, 50, 75, 100, 125, 150
32	200, 250, 300
40	

Note 1) Manufacture of intermediate strokes in 1 mm increments is possible. (Spacers are not used.)

Note 2) Applicable strokes should be confirmed according to the usage. For details, refer to "Air Cylinders Model Selection" in the **Web Catalog**. In addition, the products that exceed the standard stroke might not be able to fulfill the specifications due to the deflection etc.



**Made to Order**  
[Click here for details](#)

Symbol	Specifications
-XC3	Special port location
-XC52	Mounting nut with set screw

**Ordering Example of Cylinder Assembly**

Cylinder model: **CDM2XC40-150Z-NV-M9BW**

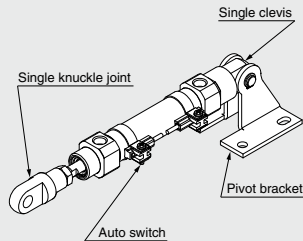

**Mounting C:** Single clevis  
**Pivot bracket N:** Yes  
**Rod end bracket V:** Single knuckle joint  
**Auto switch D-M9BW:** 2 pcs.

\* Pivot bracket, single knuckle joint and auto switch are shipped together with the product, but not assembled.

\* Pivot bracket is only applicable to mounting C, T, U, E, V and UZ.

\* No rod end bracket is provided for the female rod end type.

**Specifications**

Bore size (mm)	20	25	32	40
<b>Type</b>	Pneumatic			
<b>Action</b>	Double acting, Single rod			
<b>Fluid</b>	Air			
<b>Proof pressure</b>	1.5 MPa			
<b>Maximum operating pressure</b>	1.0 MPa			
<b>Ambient and fluid temperature</b>	Without auto switch: -10°C to 70°C (No freezing) With auto switch: -10°C to 60°C			
<b>Cushion</b>	Rubber bumper			
<b>Lubrication</b>	Not required (Non-lube)			
<b>Stroke length tolerance</b>	+1.4 mm 0			

**Minimum Operating Pressure**

Bore size (mm)	20	25	32	40
Minimum operating pressure	0.025			

Unit: MPa

**Piston Speed**

Bore size (mm)	20	25	32	40	
Piston speed (mm/s)	0.5 to 300				
Allowable kinetic energy (J)	(Male thread)	0.27	0.4	0.65	1.2
	(Female thread)	0.11	0.18	0.29	0.52

**Mounting Brackets/Part No.**

Mounting bracket	Min. order q'ty	Bore size (mm)			Contents (for minimum order quantity)
		20	25	32	
Axial foot*1	2	CM-L020B	CM-L032B	CM-L040B	2 feet, 1 mounting nut
Flange	1	CM-F020B	CM-F032B	CM-F040B	1 flange
Single clevis*2	1	CM-C020B	CM-C032B	CM-C040B	1 single clevis, 3 liners
Double clevis (with pin)*3	1	CM-D020B	CM-D032B	CM-D040B	1 double clevis, 3 liners, 1 clevis pin, 2 retaining rings
Trunnion (with nut)	1	CM-T020B	CM-T032B	CM-T040B	1 trunnion, 1 trunnion nut

\*1 Order 2 feet per cylinder.

\*2 3 liners are included with a clevis bracket for adjusting the mounting angle.

\*3 A clevis pin and retaining rings (split pins for ø40) are included.

\*4 Stainless steel mounting brackets and accessories are also available. Refer to page 292 for details.

**Mounting and Accessories** / For details about accessories, refer to pages 291 to 293.

Accessories	Standard			Option				
	Mounting nut	Rod end nut	Clevis pin	Single knuckle joint	Double knuckle joint	Note 4) Clevis pivot bracket	Note 6) Pivot bracket	Note 7) Pivot bracket pin
Basic (Double-side bossed)	● (1 pc.)	●	—	●	●	—	—	—
Axial foot	● (2)	●	—	●	●	—	—	—
Rod flange	● (1)	●	—	●	●	—	—	—
Head flange	● (1)	●	—	●	●	—	—	—
Integrated clevis	— Note 1)	●	—	●	●	●	—	—
Single clevis	— Note 1)	●	—	●	●	—	●	●
Double clevis	Note 3) — Note 1)	●	Note 5) ●	●	●	—	—	—
Rod trunnion	● (1) Note 2)	●	—	●	●	—	—	—
Head trunnion	● (1) Note 2)	●	—	●	●	—	●	—
Boss-cut/Basic	● (1)	●	—	●	●	—	—	—
Boss-cut/Flange	● (1)	●	—	●	●	—	—	—
Boss-cut/Trunnion	● (1) Note 2)	●	—	●	●	—	—	—

Note 1) Mounting nuts are not attached to the integrated clevis, single clevis and double clevis types.  
Note 2) Trunnion nuts are mounted on the rod trunnion and head trunnion types.

Note 3) A pin and retaining rings (split pins for ø40) are included with the double clevis and double knuckle joint types.

Note 4) A pin and retaining rings are included with the clevis pivot bracket.

Note 5) Retaining rings (split pins for ø40) are included with the clevis pin.

Note 6) A pin and retaining rings are included with the pivot bracket.

Note 7) Retaining rings are included with the pivot bracket pin.

## ⚠ Precautions

Be sure to read this before handling the products.

Refer to page 9 for safety instructions and pages 10 to 19 for actuator and auto switch precautions.

### Operating Precautions

#### ⚠ Warning

**1. Do not rotate the cover.**

If a cover is rotated when installing a cylinder or screwing a fitting into the port, it is likely to damage the junction part with cover.

#### ⚠ Caution

**1. Not able to disassemble.**

Cover and cylinder tube are connected to each other by caulking method, thus making it impossible to disassemble. Therefore, internal parts of a cylinder other than rod seal are not replaceable.

**2. Use caution to the popping of a retaining ring.**

When replacing rod seals and removing and mounting a retaining ring, use a proper tool (retaining ring plier: tool for installing a type C retaining ring). Even if a proper tool is used, it is likely to inflict damage to a human body or peripheral equipment, as a retaining ring may be flown out of the tip of a plier. Be much careful with the popping of a retaining ring. Besides, be certain that a retaining ring is placed firmly into the groove of rod cover before supplying air at the time of installment.

**3. Do not use an air cylinder as an air-hydro cylinder.**

If it uses turbine oil in place of fluids for cylinder, it may result in oil leakage.

**4. The oil stuck to the cylinder is grease.**

**5. The base oil of grease may seep out.**

The base oil of grease in the cylinder may seep out of the tube, cover, crimped part or rod bushing depending on the operating conditions (ambient temperature 40°C or more, pressurized condition, low frequency operation).

### Maintenance

#### ⚠ Caution

**1. Replacement parts/Seal kit**

Order it in accordance with the bore size.

Bore size (mm)	Kit no.	Contents
20	CM2X20-PS	
25	CM2X25-PS	Rod seal 1 pc.
32	CM2X32-PS	Grease pack (10 g) 1 pc.
40	CM2X40-PS	

**2. Grease pack**

When maintenance requires only grease, use the following part numbers to order.

**Grease pack part number:**

**GR-L-005** (5 g)

**GR-L-010** (10 g)

**GR-L-150** (150 g)

**Basic (Double-side Bossed) (B)**

CM2XB  -

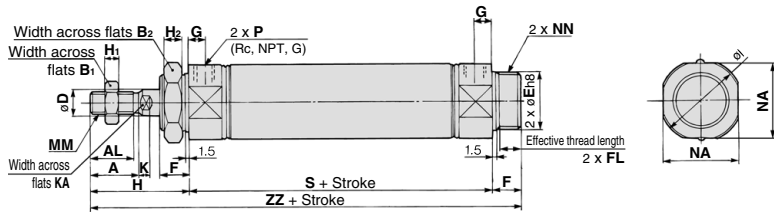

**Boss-cut**

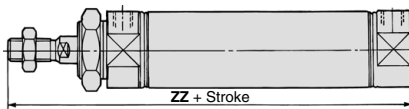

**Female rod end**

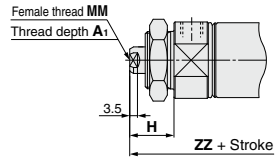

Bore size	A	AL	B <sub>1</sub>	B <sub>2</sub>	D	E	F	FL	G	H	H <sub>1</sub>	H <sub>2</sub>	I	K	KA	MM	NA	NN	P	S	ZZ
20	18	15.5	13	26	8	20 <sup>0</sup> <sub>-0.033</sub>	13	10.5	8	41	5	8	28	5	6	M8 x 1.25	24	M20 x 1.5	1/8	62	116
25	22	19.5	17	32	10	26 <sup>0</sup> <sub>-0.033</sub>	13	10.5	8	45	6	8	33.5	5.5	8	M10 x 1.25	30	M26 x 1.5	1/8	62	120
32	22	19.5	17	32	12	26 <sup>0</sup> <sub>-0.033</sub>	13	10.5	8	45	6	8	37.5	5.5	10	M10 x 1.25	34.5	M26 x 1.5	1/8	64	122
40	24	21	22	41	14	32 <sup>0</sup> <sub>-0.039</sub>	16	13.5	11	50	8	10	46.5	7	12	M14 x 1.5	42.5	M32 x 2	1/4	88	154

**Boss-cut** (mm)

Bore size	ZZ
20	103
25	107
32	109
40	138

**Female Rod End** (mm)

Bore size	A <sub>1</sub>	H	MM	ZZ
20	8	20	M4 x 0.7	95
25	8	20	M5 x 0.8	95
32	12	20	M6 x 1	97
40	13	21	M8 x 1.25	125

- \* When female thread is used, use a thin wrench when tightening the piston rod.
- \* When female thread is used, use a washer etc. to prevent the contact part at the rod end from being deformed depending on the material of the workpiece.

# CM2X Series

## Axial Foot (L)

CM2XL  -

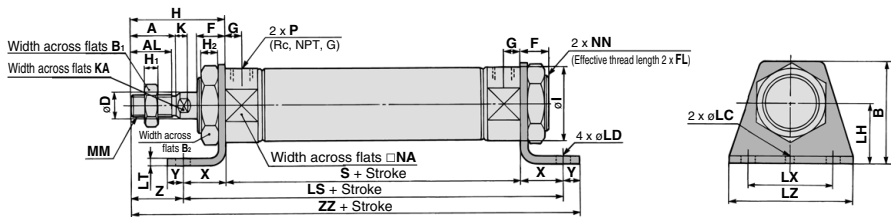

### Female rod end

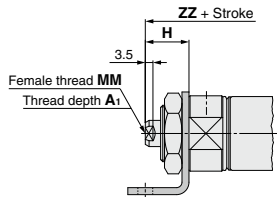

Bore size	A	AL	B	B <sub>1</sub>	B <sub>2</sub>	D	F	FL	G	H	H <sub>1</sub>	H <sub>2</sub>	I	K	KA	LC	LD	LH	LS	LT	LX	LZ	MM	NA	NN	P	S	X	Y	Z	ZZ
20	18	15.5	40	13	26	8	13	10.5	8	41	5	8	28	5	6	4	6.8	25	102	3.2	40	55	M8 x 1.25	24	M20 x 1.5	1/8	62	20	8	21	131
25	22	19.5	47	17	32	10	13	10.5	8	45	6	8	33.5	5.5	8	4	6.8	28	102	3.2	40	55	M10 x 1.25	30	M26 x 1.5	1/8	62	20	8	25	135
32	22	19.5	47	17	32	12	13	10.5	8	45	6	8	37.5	5.5	10	4	6.8	28	104	3.2	40	55	M10 x 1.25	34.5	M26 x 1.5	1/8	64	20	8	25	137
40	24	21	54	22	41	14	16	13.5	11	50	8	10	46.5	7	12	4	7	30	134	3.2	55	75	M14 x 1.5	42.5	M32 x 2	1/4	88	23	10	27	171

\* Mounting bracket is shipped together with the product.

### Female Rod End (mm)

Bore size	A <sub>1</sub>	H	MM	ZZ
20	8	20	M4 x 0.7	110
25	8	20	M5 x 0.8	110
32	12	20	M6 x 1	112
40	13	21	M8 x 1.25	142

\* When female thread is used, use a thin wrench when tightening the piston rod.

\* When female thread is used, use a washer etc. to prevent the contact part at the rod end from being deformed depending on the material of the workpiece.

## Rod Flange (F)

CM2XF  -

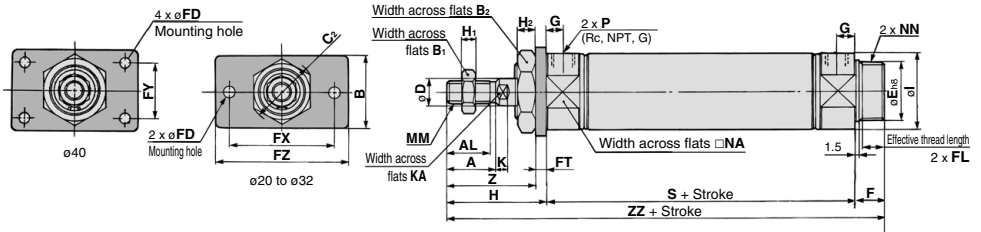

### Boss-cut

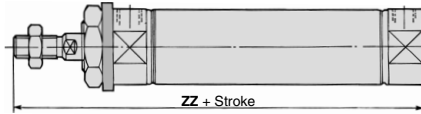

### Female rod end

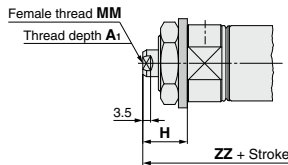

(mm)

Bore size	A	AL	B	B <sub>1</sub>	B <sub>2</sub>	C <sub>2</sub>	D	E	F	FL	FD	FT	FX	FY	FZ	G	H	H <sub>1</sub>	H <sub>2</sub>	I	K	KA	MM	NA	NN	P	S	Z	ZZ
20	18	15.5	34	13	26	30	8	20 <sup>0</sup> <sub>-0.033</sub>	13	10.5	7	4	60	—	75	8	41	5	8	28	5	6	M8 x 1.25	24	M20 x 1.5	1/8	62	37	116
25	22	19.5	40	17	32	37	10	26 <sup>0</sup> <sub>-0.033</sub>	13	10.5	7	4	60	—	75	8	45	6	8	33.5	5.5	8	M10 x 1.25	30	M26 x 1.5	1/8	62	41	120
32	22	19.5	40	17	32	37	12	26 <sup>0</sup> <sub>-0.033</sub>	13	10.5	7	4	60	—	75	8	45	6	8	37.5	5.5	10	M10 x 1.25	34.5	M26 x 1.5	1/8	64	41	122
40	24	21	52	22	41	47.3	14	32 <sup>0</sup> <sub>-0.039</sub>	16	13.5	7	5	66	36	82	11	50	8	10	46.5	7	12	M14 x 1.5	42.5	M32 x 2	1/4	88	45	154

### Boss-cut (mm)

Bore size	ZZ
20	103
25	107
32	109
40	138

### Female Rod End (mm)

Bore size	A <sub>1</sub>	H	MM	ZZ
20	8	20	M4 x 0.7	95
25	8	20	M5 x 0.8	95
32	12	20	M6 x 1	97
40	13	21	M8 x 1.25	125

\* Mounting bracket is shipped together with the product.

\* When female thread is used, use a thin wrench when tightening the piston rod.

\* When female thread is used, use a washer etc. to prevent the contact part at the rod end from being deformed depending on the material of the workpiece.

# CM2X Series

## Head Flange (G)

CM2XG  -

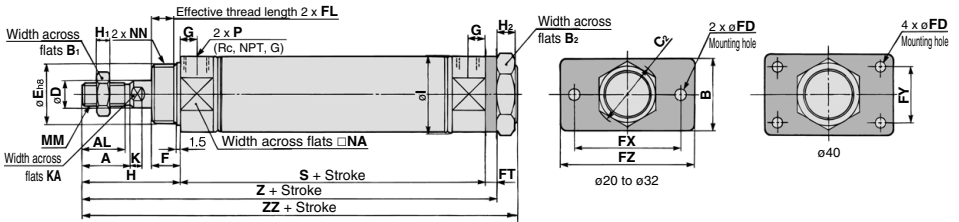

## Female rod end

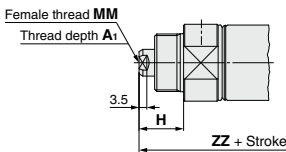

Bore size	A	AL	B	B <sub>1</sub>	B <sub>2</sub>	C <sub>2</sub>	D	E	F	FL	FD	FT	FX	FY	FZ	G	H	H <sub>1</sub>	H <sub>2</sub>	I
20	18	15.5	34	13	26	30	8	20 <sup>0</sup> <sub>-0.033</sub>	13	10.5	7	4	60	—	75	8	41	5	8	28
25	22	19.5	40	17	32	37	10	26 <sup>0</sup> <sub>-0.033</sub>	13	10.5	7	4	60	—	75	8	45	6	8	33.5
32	22	19.5	40	17	32	37	12	26 <sup>0</sup> <sub>-0.033</sub>	13	10.5	7	4	60	—	75	8	45	6	8	37.5
40	24	21	52	22	41	47.3	14	32 <sup>0</sup> <sub>-0.039</sub>	16	13.5	7	5	66	36	82	11	50	8	10	46.5

(mm)

Bore size	K	KA	MM	NA	NN	P	S	Z	ZZ
20	5	6	M8 x 1.25	24	M20 x 1.5	1/8	62	107	116
25	5.5	8	M10 x 1.25	30	M26 x 1.5	1/8	62	111	120
32	5.5	10	M10 x 1.25	34.5	M26 x 1.5	1/8	64	113	122
40	7	12	M14 x 1.5	42.5	M32 x 2	1/4	88	143	154

(mm)

## Female Rod End

Bore size	A <sub>1</sub>	H	MM	ZZ
20	8	20	M4 x 0.7	95
25	8	20	M5 x 0.8	95
32	12	20	M6 x 1	97
40	13	21	M8 x 1.25	125

(mm)

\* Mounting bracket is shipped together with the product.

\* When female thread is used, use a thin wrench when tightening the piston rod.

\* When female thread is used, use a washer etc. to prevent the contact part at the rod end from being deformed depending on the material of the workpiece.



### Single Clevis (C)

CM2XC Bore size – Stroke  Z

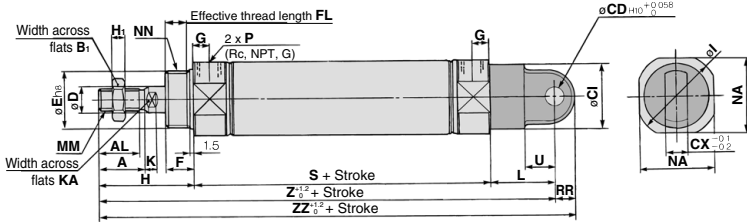

#### Female rod end

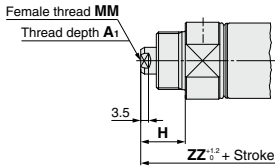

#### Female Rod End

(mm)

Bore size	A <sub>1</sub>	H	MM	(ZZ)
20	8	20	M4 x 0.7	121
25	8	20	M5 x 0.8	121
32	12	20	M6 x 1	123
40	13	21	M8 x 1.25	159

- \* When female thread is used, use a thin wrench when tightening the piston rod.
- \* When female thread is used, use a washer etc. to prevent the contact part at the rod end from being deformed depending on the material of the workpiece.

Bore size	A	AL	B <sub>1</sub>	Cl	CD	CX	D	E	F	FL	G	H	H <sub>1</sub>	I	K	KA	L	MM	NA	NN	P	RR	S	U	(Z)	(ZZ)
20	18	15.5	13	24	9	10	8	20 <sup>0</sup> <sub>0.033</sub>	13	10.5	8	41	5	28	5	6	30	M8 x 1.25	24	M20 x 1.5	1/8	9	62	14	133	142
25	22	19.5	17	30	9	10	10	26 <sup>0</sup> <sub>0.088</sub>	13	10.5	8	45	6	33.5	5.5	8	30	M10 x 1.25	30	M26 x 1.5	1/8	9	62	14	137	146
32	22	19.5	17	30	9	10	12	26 <sup>0</sup> <sub>0.033</sub>	13	10.5	8	45	6	37.5	5.5	10	30	M10 x 1.25	34.5	M26 x 1.5	1/8	9	64	14	139	148
40	24	21	22	38	10	15	14	32 <sup>0</sup> <sub>0.099</sub>	16	13.5	11	50	8	46.5	7	12	39	M14 x 1.5	42.5	M32 x 2	1/4	11	88	18	177	188

### Double Clevis (D)

CM2XD Bore size – Stroke  Z

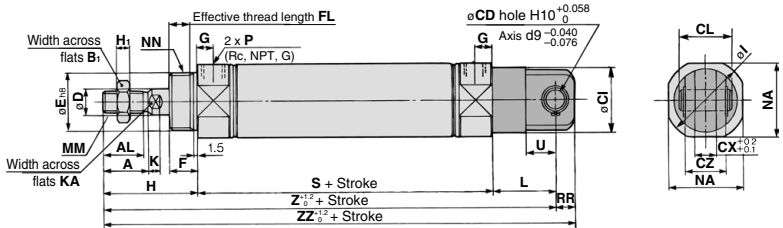

#### Female rod end

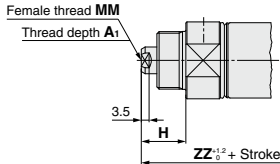

#### Female Rod End

(mm)

Bore size	A <sub>1</sub>	H	MM	(ZZ)
20	8	20	M4 x 0.7	121
25	8	20	M5 x 0.8	121
32	12	20	M6 x 1	123
40	13	21	M8 x 1.25	159

- \* When female thread is used, use a thin wrench when tightening the piston rod.
- \* When female thread is used, use a washer etc. to prevent the contact part at the rod end from being deformed depending on the material of the workpiece.

Bore size	A	AL	B <sub>1</sub>	Cl	CL	CX	CZ	D	E	F	FL	G	H	H <sub>1</sub>	I	K	KA	L	MM	NA	NN	P	RR	S	U	(Z)	(ZZ)	
20	18	15.5	13	9	24	25	10	19	8	20 <sup>0</sup> <sub>0.033</sub>	13	10.5	8	41	5	28	5	6	30	M8 x 1.25	24	M20 x 1.5	1/8	9	62	14	133	142
25	22	19.5	17	9	30	25	10	19	10	26 <sup>0</sup> <sub>0.033</sub>	13	10.5	8	45	6	33.5	5.5	8	30	M10 x 1.25	30	M26 x 1.5	1/8	9	62	14	137	146
32	22	19.5	17	9	30	25	10	19	12	26 <sup>0</sup> <sub>0.033</sub>	13	10.5	8	45	6	37.5	5.5	10	30	M10 x 1.25	34.5	M26 x 1.5	1/8	9	64	14	139	148
40	24	21	22	10	38	41.2	15	30	14	32 <sup>0</sup> <sub>0.099</sub>	16	13.5	11	50	8	46.5	7	12	39	M14 x 1.5	42.5	M32 x 2	1/4	11	88	18	177	188

\* A clevis pin and retaining rings (split pins for ø40) are shipped together.

# CM2X Series

## Rod Trunnion (U)

CM2XU  -

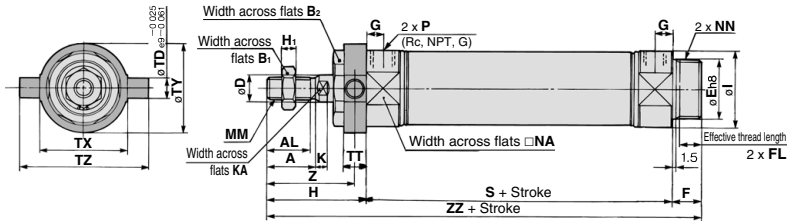

### Boss-cut

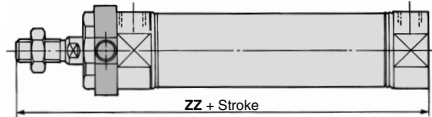

### Female rod end

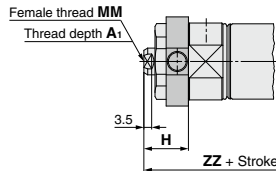

\* Mounting bracket is shipped together with the product.

Bore size	A	AL	B <sub>1</sub>	B <sub>2</sub>	D	E	F	FL	G	H	H <sub>1</sub>	I	K	KA	MM	NA	NN	P
20	18	15.5	13	26	8	20 <sup>0</sup> <sub>-0.033</sub>	13	10.5	8	41	5	28	5	6	M8 x 1.25	24	M20 x 1.5	1/8
25	22	19.5	17	32	10	26 <sup>0</sup> <sub>-0.033</sub>	13	10.5	8	45	6	33.5	5.5	8	M10 x 1.25	30	M26 x 1.5	1/8
32	22	19.5	17	32	12	26 <sup>0</sup> <sub>-0.033</sub>	13	10.5	8	45	6	37.5	5.5	10	M10 x 1.25	34.5	M26 x 1.5	1/8
40	24	21	22	41	14	32 <sup>0</sup> <sub>-0.039</sub>	16	13.5	11	50	8	46.5	7	12	M14 x 1.5	42.5	M32 x 2	1/4

Bore size	S	TD	TT	TX	TY	TZ	Z	ZZ
20	62	8	10	32	32	52	36	116
25	62	9	10	40	40	60	40	120
32	64	9	10	40	40	60	40	122
40	88	10	11	53	53	77	44.5	154

Bore size	ZZ
20	103
25	107
32	109
40	138

Bore size	A <sub>1</sub>	H	MM	ZZ
20	8	20	M4 x 0.7	95
25	8	20	M5 x 0.8	95
32	12	20	M6 x 1	97
40	13	21	M8 x 1.25	125

\* When female thread is used, use a thin wrench when tightening the piston rod.

\* When female thread is used, use a washer etc. to prevent the contact part at the rod end from being deformed depending on the material of the workpiece.

## Head Trunnion (T)

CM2XT  -

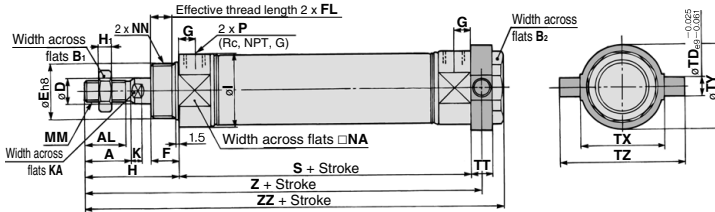

### Female rod end

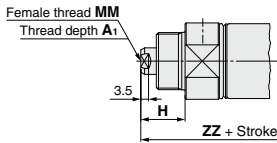

\* Mounting bracket is shipped together with the product.

Bore size	A	AL	B <sub>1</sub>	B <sub>2</sub>	D	E	F	FL	G	H	H <sub>1</sub>	I	K	KA	MM	NA	NN	P
20	18	15.5	13	26	8	20 <sup>0</sup> <sub>-0.033</sub>	13	10.5	8	41	5	28	5	6	M8 x 1.25	24	M20 x 1.5	1/8
25	22	19.5	17	32	10	26 <sup>0</sup> <sub>-0.033</sub>	13	10.5	8	45	6	33.5	5.5	8	M10 x 1.25	30	M26 x 1.5	1/8
32	22	19.5	17	32	12	26 <sup>0</sup> <sub>-0.033</sub>	13	10.5	8	45	6	37.5	5.5	10	M10 x 1.25	34.5	M26 x 1.5	1/8
40	24	21	22	41	14	32 <sup>0</sup> <sub>-0.039</sub>	16	13.5	11	50	8	46.5	7	12	M14 x 1.5	42.5	M32 x 2	1/4

Bore size	S	TD	TT	TX	TY	TZ	Z	ZZ
20	62	8	10	32	32	52	108	118
25	62	9	10	40	40	60	112	122
32	64	9	10	40	40	60	114	124
40	88	10	11	53	53	77	143.5	154

### Female Rod End

Bore size	A <sub>1</sub>	H	MM	ZZ
20	8	20	M4 x 0.7	97
25	8	20	M5 x 0.8	97
32	12	20	M6 x 1	99
40	13	21	M8 x 1.25	125

\* When female thread is used, use a thin wrench when tightening the piston rod.

\* When female thread is used, use a washer etc. to prevent the contact part at the rod end from being deformed depending on the material of the workpiece.

# CM2X Series

## Integrated Clevis (E)

CM2XE  -

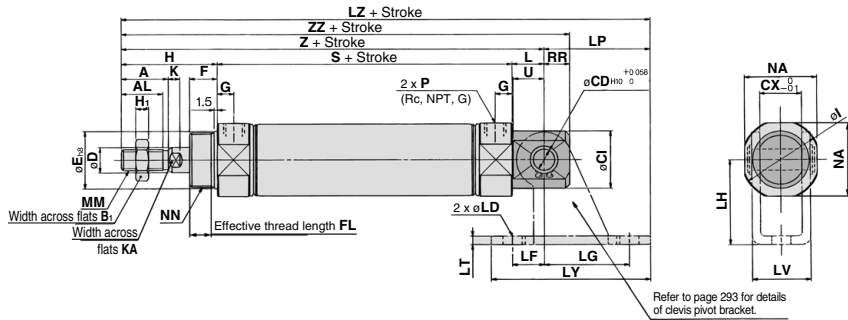

### Female rod end

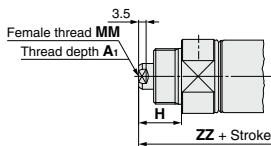

### Integrated clevis (90°) (V)

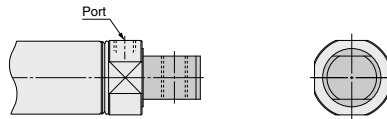

\* The outer dimensions are the same as those for the integrated clevis (E).

Bore size	A	AL	B <sub>1</sub>	CD	CI	CX	D	E	F	FL	G	H	H <sub>1</sub>	I	K	KA	L	MM	NA	NN
20	18	15.5	13	8	20	12	8	20 <sup>0</sup> <sub>-0.033</sub>	13	10.5	8	41	5	28	5	6	12	M8 x 1.25	24	M20 x 1.5
25	22	19.5	17	8	22	12	10	26 <sup>0</sup> <sub>-0.033</sub>	13	10.5	8	45	6	33.5	5.5	8	12	M10 x 1.25	30	M26 x 1.5
32	22	19.5	17	10	27	20	12	26 <sup>0</sup> <sub>-0.033</sub>	13	10.5	8	45	6	37.5	5.5	10	15	M10 x 1.25	34.5	M26 x 1.5
40	24	21	22	10	33	20	14	32 <sup>0</sup> <sub>-0.039</sub>	16	13.5	11	50	8	46.5	7	12	15	M14 x 1.5	42.5	M32 x 2

(mm)						
Bore size	P	RR	S	U	Z	ZZ
20	1/8	9	62	11.5	115	124
25	1/8	9	62	11.5	119	128
32	1/8	12	64	14.5	124	136
40	1/4	12	88	14.5	153	165

Female Rod End				(mm)	
Bore size	A <sub>1</sub>	H	MM	ZZ	
20	8	20	M4 x 0.7	103	
25	8	20	M5 x 0.8	103	
32	12	20	M6 x 1	111	
40	13	21	M8 x 1.25	136	

\* When female thread is used, use a thin wrench when tightening the piston rod.

\* When female thread is used, use a washer etc. to prevent the contact part at the rod end from being deformed depending on the material of the workpiece.

# CM2X Series

# Dimensions of Accessories

## With Single Knuckle Joint

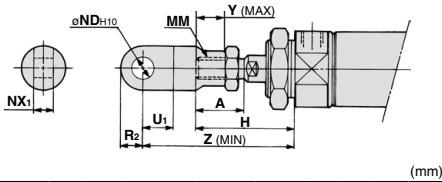

Bore size	A	H	MM	ND <sub>H10</sub>	NX <sub>1</sub>	U <sub>1</sub>	R <sub>2</sub>	Y	Z
20	18	41	M8 x 1.25	9 <sup>+0.058</sup> <sub>0</sub>	9 <sup>+0.2</sup> <sub>0</sub>	14	10	11	66
25, 32	22	45	M10 x 1.25	9 <sup>+0.058</sup> <sub>0</sub>	9 <sup>+0.2</sup> <sub>0</sub>	14	10	14	69
40	24	50	M14 x 1.5	12 <sup>+0.070</sup> <sub>0</sub>	16 <sup>+0.3</sup> <sub>0</sub>	20	14	13	92

## Single Knuckle Joint

I-020B, 032B Material: Carbon steel I-040B Material: Free-cutting steel

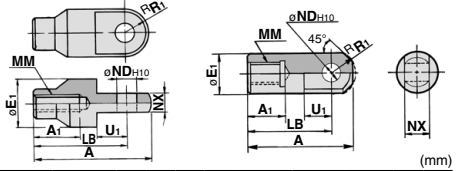

Part no.	Applicable bore size	A	A <sub>1</sub>	E <sub>1</sub>	LB	MM	ND <sub>H10</sub>	NX	R <sub>1</sub>	U <sub>1</sub>
I-020B	20	46	16	20	36	M8 x 1.25	9 <sup>+0.058</sup> <sub>0</sub>	9 <sup>+0.2</sup> <sub>0</sub>	10	14
I-032B	25, 32	48	18	20	38	M10 x 1.25	9 <sup>+0.058</sup> <sub>0</sub>	9 <sup>+0.2</sup> <sub>0</sub>	10	14
I-040B	40	69	22	24	55	M14 x 1.5	12 <sup>+0.070</sup> <sub>0</sub>	16 <sup>+0.3</sup> <sub>0</sub>	15.5	20

## With Double Knuckle Joint

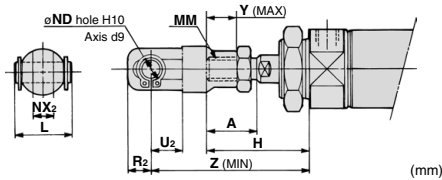

Bore size	A	H	L	MM	ND	NX <sub>2</sub>	R <sub>2</sub>	U <sub>2</sub>	Y	Z
20	18	41	25	M8 x 1.25	9	9 <sup>+0.2</sup> <sub>0</sub>	10	14	11	66
25, 32	22	45	25	M10 x 1.25	9	9 <sup>+0.2</sup> <sub>0</sub>	10	14	14	69
40	24	50	49.7	M14 x 1.5	12	16 <sup>+0.3</sup> <sub>0</sub>	13	25	13	92

## Double Knuckle Joint

Y-020B, 032B Material: Carbon steel

Y-040B Material: Cast iron

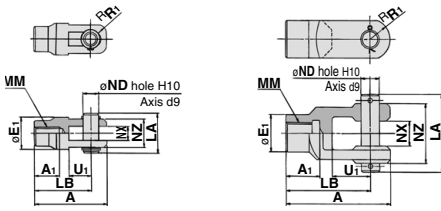

Part no.	Applicable bore size	A	A <sub>1</sub>	E <sub>1</sub>	LA	LB	MM	ND	NX	NZ	R <sub>1</sub>	U <sub>1</sub>	Included pin part number	Retaining ring size Split pin
Y-020B	20	46	16	20	25	36	M8 x 1.25	9	9 <sup>+0.2</sup> <sub>0</sub>	18	5	14	CDP-1	Type C 9 for axis
Y-032B	25, 32	48	18	20	25	38	M10 x 1.25	9	9 <sup>+0.2</sup> <sub>0</sub>	18	5	14	CDP-1	Type C 9 for axis
Y-040B	40	68	22	24	49.7	55	M14 x 1.5	12	16 <sup>+0.3</sup> <sub>0</sub>	38	13	25	CDP-3	ø3 x 18 L

\* A knuckle pin and retaining rings (split pins for ø40) are included.

## Double Clevis Pin

Bore size/ø20, ø25, ø32

CDP-1

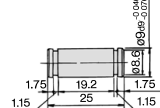

Retaining ring: Type C9 for axis

Bore size/ø40

CDP-2

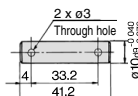

Split pin: ø3 x 18 L

\* Retaining rings (split pins for ø40) are included.

## Double Knuckle Pin

Bore size/ø20, ø25, ø32

CDP-1

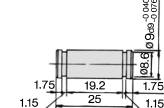

Retaining ring: Type C9 for axis

\* Retaining rings (split pins for ø40) are included.

Bore size/ø40

CDP-3

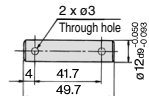

Split pin: ø3 x 18 L

# CM2X Series

## Rod End Nut

Material: Carbon steel

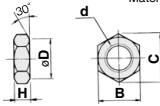

Part no.	Applicable bore size	B	C	D	d	H
NT-02	20	13	15.0	12.5	M8 x 1.25	5
NT-03	25, 32	17	19.6	16.5	M10 x 1.25	6
NT-04	40	22	25.4	21.0	M14 x 1.5	8

## Mounting Nut

Material: Carbon steel

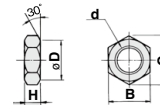

Part no.	Applicable bore size	B	C	D	d	H
SN-020B	20	26	30	25.5	M20 x 1.5	8
SN-032B	25, 32	32	37	31.5	M26 x 1.5	8
SN-040B	40	41	47.3	40.5	M32 x 2.0	10

## Trunnion Nut

Material: Carbon steel

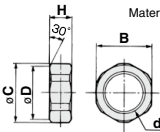

Part no.	Applicable bore size	B	C	D	d	H
TN-020B	20	26	28	25.5	M20 x 1.5	10
TN-032B	25, 32	32	34	31.5	M26 x 1.5	10
TN-040B	40	41	45	40.5	M32 x 2	10

## Mounting Brackets, Rod End Brackets, and Nut Material: Stainless Steel

Part No. (Dimensions: Same as standard type)

Bore size (mm)	Foot	Flange	Single knuckle joint	Double knuckle joint*	Mounting nut	Rod end nut
20	CM-L020BSUS	CM-F020BSUS	I-020BSUS	Y-020BSUS	SN-020BSUS	NT-02SUS
25, 32	CM-L032BSUS	CM-F032BSUS	I-032BSUS	Y-032BSUS	SN-032BSUS	NT-03SUS
40	CM-L040BSUS	CM-F040BSUS	I-040BSUS	Y-040BSUS	SN-040BSUS	NT-04SUS

\* A knuckle pin and retaining rings are shipped together. Refer to the XC27 for details on stainless steel double clevis pins and double knuckle pins. The accessories need to be ordered separately from the cylinder.

## Clevis Pivot Bracket (For CM2XE(V))

Material: Carbon steel

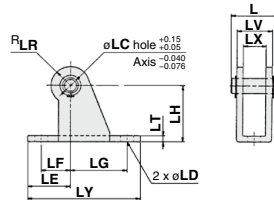

Part no.	Applicable bore size	L	LC	LD	LE	LF	LG	LH	LR	LT	LX	LY	LV	Included pin part no.
CM-E020B	20, 25	24.5	8	6.8	22	15	30	30	10	3.2	12	59	18.4	CD-S02
CM-E032B	32, 40	34	10	9	25	15	40	40	13	4	20	75	28	CD-S03

Note 1) A clevis pivot bracket pin and retaining rings are included.  
Note 2) It cannot be used for the single clevis (CM2XC) and the double clevis (CM2XD).

## Clevis Pivot Bracket Pin (For CM2XE(V))

Material: Carbon steel

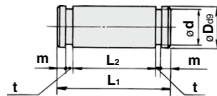

Part no.	Applicable bore size	D <sub>99</sub>	d	L <sub>1</sub>	L <sub>2</sub>	m	t	Included retaining ring
CD-S02	20, 25	8 <sup>+0.040</sup> <sub>-0.076</sub>	7.6	24.5	19.5	1.6	0.9	Type C 8 for axis
CD-S03	32, 40	10 <sup>+0.040</sup> <sub>-0.076</sub>	9.6	34	29	1.35	1.15	Type C 10 for axis

Note) Retaining rings are included.

### With Single Clevis

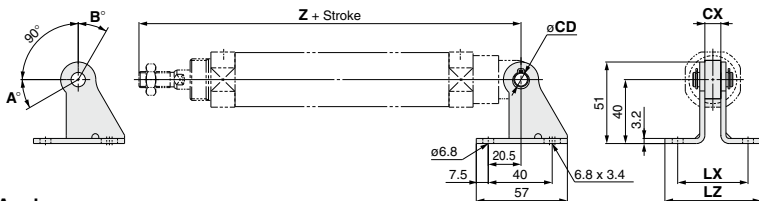

#### Rotation Angle

Bore size (mm)	A°	B°	A° + B° + 90°
20	25	85	200
25, 32	21	81	192
40	26	86	202

Mounting	Part no.	Applicable bore size	CX	Z + Stroke	CD	LX	LZ
CM2XC (Single clevis)	CM-B032	20	10	133	9	44	60
		25		137			
		32		139			
	CM-B040	40	15	177	10	49	65

Note) A pivot bracket pin and retaining rings are not included with the pivot bracket.

### With Rod Trunnion

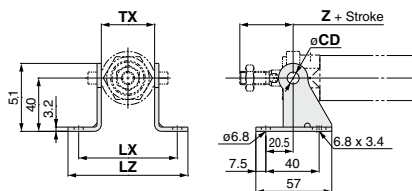

### With Head Trunnion

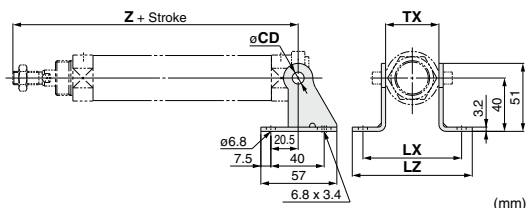

Mounting	Part no.	Applicable bore size	TX	Rod trunnion	Head trunnion	CD	LX	LZ
				Z + Stroke	Z + Stroke			
CM2XU/CM2XT (Rod/Head trunnion)	CM-B020	20	32	36	108	8	66	82
		25	40	40	112	9	74	90
	CM-B032	32	40	40	114	9	74	90
		40	53	44.5	143.5	10	87	103

Note) A pivot bracket pin and retaining rings are not included with the pivot bracket.

### Pivot Bracket

\* Pivot brackets consists of a set of two brackets.

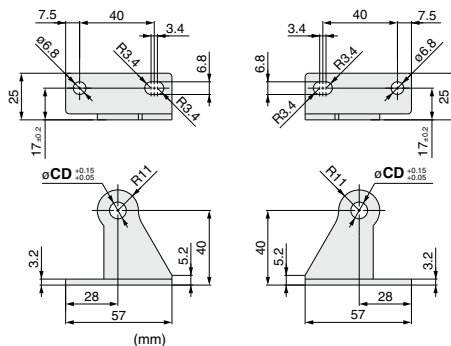

Part no.	CD
CM-B020 (Note 2)	8
CM-B032	9
CM-B040	10

Note 1) A pivot bracket pin and retaining rings are not included with the pivot bracket.  
Note 2) Only for the trunnion

### Pivot Bracket Pin (For CM2XC)

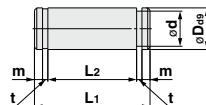

Applicable bore size	Part no.	D <sub>99</sub>	d	L1	L2	m	t	Included retaining ring
20 to 32	CDP-1	9 <sup>+0.040</sup> <sub>-0.078</sub>	8.6	25	19.2	1.75	1.15	Type C 9 for axis
40	CD-S03	10 <sup>+0.040</sup> <sub>-0.078</sub>	9.6	34	29	1.35	1.15	Type C 10 for axis

Note) Retaining rings are included with the pivot bracket pin.

# CM2X Series Auto Switch Mounting

## Auto Switch Proper Mounting Position (Detection at stroke end) and Its Mounting Height

### Solid state auto switch

- D-M9□
- D-M9□W
- D-M9□A

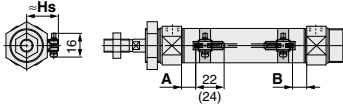

( ): Dimension of the D-M9□A  
A and B are the dimensions from the end of the head cover/rod cover to the end of the auto switch.

- D-M9□V
- D-M9□WV
- D-M9□AV

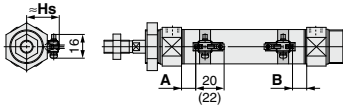

( ): Dimension of the D-M9□AV  
A and B are the dimensions from the end of the head cover/rod cover to the end of the auto switch.

### D-H7□/H7□W/H7NF/H7BA/H7C

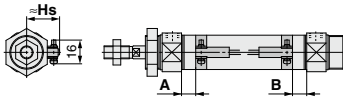

### D-G5NT

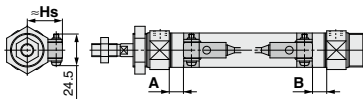

### D-G39A/K39A

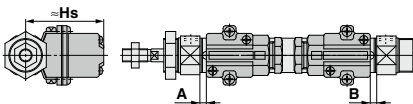

### Reed auto switch

- D-A9□

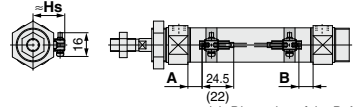

( ): Dimension of the D-A96  
A and B are the dimensions from the end of the head cover/rod cover to the end of the auto switch.

- D-A9□V

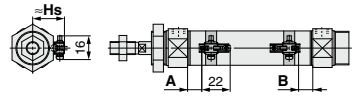

A and B are the dimensions from the end of the head cover/rod cover to the end of the auto switch.

### D-C7/C8/C73C/C80C

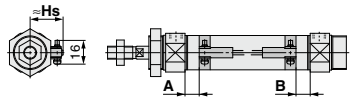

### D-B5/B6/B59W

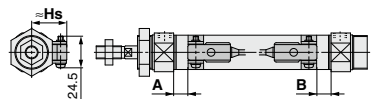

### D-A33A/A34A

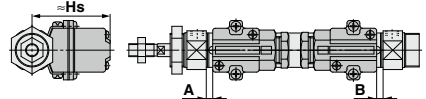

### D-A44A

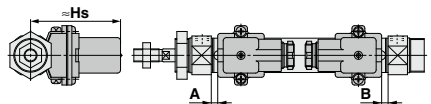



**Auto Switch Proper Mounting Position (Detection at stroke end) and Its Mounting Height**
**Auto Switch Proper Mounting Position**

(mm)

Auto switch model	D-M9□(V) D-M9□W(V) D-M9□A(V)		D-A9□(V)		D-B5□ D-B64		D-C7□ D-C80 D-C73C D-C80C		D-B59W		D-A3□A D-G39A D-K39A D-A44A		D-H7□ D-H7C D-H7□W D-H7NF		D-G5NT	
	A	B	A	B	A	B	A	B	A	B	A	B	A	B	A	B
<b>20</b>	11	9.5	7	5.5	1	0	7	6	4	3	0.5	0	6	5	2.5	1.5
<b>25</b>	10	10	6	6	1	0	7	6	4	3	0.5	0	6	5	2.5	1.5
<b>32</b>	11.5	10.5	7.5	6.5	2	1	8	7	5	4	1.5	0.5	7	6	3.5	2.5
<b>40</b>	17.5	15.5	13.5	11.5	7	6	13	12	10	9	6.5	5.5	12	11	8.5	7.5

Note) Adjust the auto switch after confirming the operating condition in the actual setting.

**Auto Switch Mounting Height**

(mm)

Auto switch model	D-M9□V D-M9□WV D-M9□AV D-A9□V		D-B5□ D-B64 D-B59W D-G5NT D-H7C		D-C7□ D-C80 D-H7□ D-H7□W D-H7NF		D-C73C D-C80C		D-A3□A D-G39A D-K39A		D-A44A	
	Hs	Hs	Hs	Hs	Hs	Hs	Hs	Hs	Hs	Hs	Hs	Hs
<b>20</b>	23.5	25.5	22.5	25	60	69.5						
<b>25</b>	26	28	25	27.5	62.5	72						
<b>32</b>	29.5	31.5	28.5	31	66	75.5						
<b>40</b>	33.5	35.5	32.5	35	70	79.5						

## Minimum Stroke for Auto Switch Mounting

Auto switch model	Number of auto switches <span style="float: right;">(mm)</span>				
	With 1 pc.	With 2 pcs.		With n pcs. (n: Number of auto switches)	
		Different surfaces	Same surface	Different surfaces	Same surface
D-M9□	5	15 <small>Note 1)</small>	40 <small>Note 1)</small>	$20 + 35 \frac{(n-2)}{2}$ <small>(n = 2, 4, 6...)</small> <small>Note 3)</small>	$55 + 35 (n-2)$ <small>(n = 2, 3, 4, 5...)</small>
D-M9□W	10	15 <small>Note 1)</small>	40 <small>Note 1)</small>	$20 + 35 \frac{(n-2)}{2}$ <small>(n = 2, 4, 6...)</small> <small>Note 3)</small>	$55 + 35 (n-2)$ <small>(n = 2, 3, 4, 5...)</small>
D-M9□A	10	25	40 <small>Note 1)</small>	$25 + 35 \frac{(n-2)}{2}$ <small>(n = 2, 4, 6...)</small> <small>Note 3)</small>	$60 + 35 (n-2)$ <small>(n = 2, 3, 4, 5...)</small>
D-A9□	5	15	30	$15 + 35 \frac{(n-2)}{2}$ <small>(n = 2, 4, 6...)</small> <small>Note 3)</small>	$50 + 35 (n-2)$ <small>(n = 2, 3, 4, 5...)</small>
D-M9□V	5	20	35	$20 + 35 \frac{(n-2)}{2}$ <small>(n = 2, 4, 6...)</small> <small>Note 3)</small>	$35 + 35 (n-2)$ <small>(n = 2, 3, 4, 5...)</small>
D-A9□V	5	15	25	$15 + 35 \frac{(n-2)}{2}$ <small>(n = 2, 4, 6...)</small> <small>Note 3)</small>	$25 + 35 (n-2)$ <small>(n = 2, 3, 4, 5...)</small>
D-M9□WV D-M9□AV	10	20	35	$20 + 35 \frac{(n-2)}{2}$ <small>(n = 2, 4, 6...)</small> <small>Note 3)</small>	$35 + 35 (n-2)$ <small>(n = 2, 3, 4, 5...)</small>
D-C7□ D-C80	10	15	50	$15 + 45 \frac{(n-2)}{2}$ <small>(n = 2, 4, 6...)</small> <small>Note 3)</small>	$50 + 45 (n-2)$ <small>(n = 2, 3, 4, 5...)</small>
D-H7□ D-H7□W D-H7NF	10	15	60	$15 + 45 \frac{(n-2)}{2}$ <small>(n = 2, 4, 6...)</small> <small>Note 3)</small>	$60 + 45 (n-2)$ <small>(n = 2, 3, 4, 5...)</small>
D-C73C D-C80C D-H7C	10	15	65	$15 + 50 \frac{(n-2)}{2}$ <small>(n = 2, 4, 6...)</small> <small>Note 3)</small>	$65 + 50 (n-2)$ <small>(n = 2, 3, 4, 5...)</small>
D-B5□/B64 D-G5NT	10	15	75	$15 + 50 \frac{(n-2)}{2}$ <small>(n = 2, 4, 6...)</small> <small>Note 3)</small>	$75 + 55 (n-2)$ <small>(n = 2, 3, 4, 5...)</small>
D-B59W	15	20	75	$20 + 50 \frac{(n-2)}{2}$ <small>(n = 2, 4, 6...)</small> <small>Note 3)</small>	$75 + 55 (n-2)$ <small>(n = 2, 3, 4, 5...)</small>
D-A3□/A/G39A D-K39A/A44A	10	35	100	$35 + 30 (n-2)$ <small>(n = 2, 3, 4, 5...)</small>	$100 + 100 (n-2)$ <small>(n = 2, 3, 4, 5...)</small>

Note 3) When "n" is an odd number, an even number that is one larger than this odd number is used for the calculation.

Note 1) Auto switch mounting

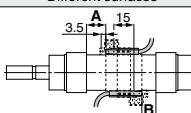
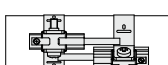
Auto switch model	With 2 auto switches	
	Different surfaces	Same surface
	 <p>The proper auto switch mounting position is 3.5 mm inward from the switch holder edge.</p>	 <p>The auto switch is mounted by slightly displacing it in a direction (cylinder tube circumferential exterior) so that the auto switch and lead wire do not interfere with each other.</p>
D-M9□ D-M9□W	Less than 20 stroke <small>Note 2)</small>	Less than 55 stroke <small>Note 2)</small>
D-M9□A	Less than 25 stroke	Less than 60 stroke <small>Note 2)</small>
D-A9□	—	Less than 50 stroke <small>Note 2)</small>

Note 2) Minimum stroke for auto switch mounting in types other than those in Note 1.

## Operating Range

Auto switch model	Bore size (mm)			
	20	25	32	40
D-A9□(V)	6	6	6	6
D-M9□(V)	3.5	3	3.5	3
D-M9□W(V)				
D-M9□A(V)				
D-C7□/C80	7	8	8	8
D-C73C/C80C				
D-B5□/B64	8	8	9	9
D-A3□/A/A44A				

  

Auto switch model	Bore size (mm)			
	20	25	32	40
D-B59W	12	12	13	13
D-H7□/H7□W	4	4	4.5	5
D-G5NT/H7NF				
D-H7C	7	8.5	9	10
D-G39A/K39A	8	9	9	9

\* Values which include hysteresis are for guideline purposes only, they are not a guarantee (assuming approximately ±30% dispersion) and may change substantially depending on the ambient environment.

**Auto Switch Mounting Brackets/Part No.**

Auto switch model	Bore size (mm)			
	ø20	ø25	ø32	ø40
D-M9□(V) D-M9□W(V) D-A9□(V)	Note 1) BM5-020 (A set of a, b, c, d)	Note 1) BM5-025 (A set of a, b, c, d)	Note 1) BM5-032 (A set of a, b, c, d)	Note 1) BM5-040 (A set of a, b, c, d)
D-M9□A(V) Note 2)	BM5-020S (A set of b, c, e, f)	BM5-025S (A set of b, c, e, f)	BM5-032S (A set of b, c, e, f)	BM5-040S (A set of b, c, e, f)

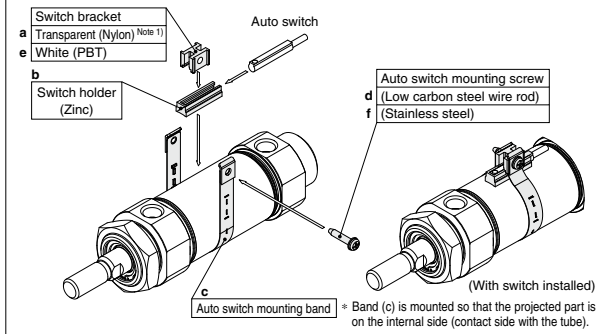

D-H7□ D-H7□W D-H7NF D-C7□/C80 D-C73C/C80C	BM2-020A (A set of c and d)	BM2-025A (A set of c and d)	BM2-032A (A set of c and d)	BM2-040A (A set of c and d)
D-H7BA	BM2-020AS (A set of c and f)	BM2-025AS (A set of c and f)	BM2-032AS (A set of c and f)	BM2-040AS (A set of c and f)
D-B5□/B64 D-B59W D-G5NT	BA2-020 (A set of c and d)	BA2-025 (A set of c and d)	BA2-032 (A set of c and d)	BA2-040 (A set of c and d)
D-A3□A/A44A D-G39A/K39A	BM3-020 (A set of c and d)	BM3-025 (A set of c and d)	BM3-032 (A set of c and d)	BM3-040 (A set of c and d)

Note 1) Since the switch bracket (made from nylon) are affected in an environment where alcohol, chloroform, methylamines, hydrochloric acid or sulfuric acid is splashed over, so it cannot be used. Please contact SMC regarding other chemicals.

Note 2) When mounting a D-M9□A(V) type auto switch, if the switch bracket is mounted on the indicator light, it may damage the auto switch. Therefore, be sure to avoid mounting the switch bracket on the indicator light.

**Band Mounting Brackets Set Part No.**

Set part no.	Contents
BJ4-1	• Switch bracket (White/PBT) (e) • Switch holder (b)
BJ5-1	• Switch bracket (Transparent/Nylon) (a) • Switch holder (b)

**Other than the applicable auto switches listed in “How to Order”, the following auto switches are mountable.**

Refer to pages 1341 to 1435 for the detailed specifications.

Type	Model	Electrical entry	Features
Reed	D-B53/C73/C76	Grommet (In-line)	—
	D-C80		Without indicator light
Solid state	D-H7A1/H7A2/H7B		—
	D-H7NW/H7PW/H7BW		Diagnostic indication (2-color indicator)
	D-G5NT		With timer

\* With pre-wired connector is also available for solid state auto switches. For details, refer to pages 1410 and 1411.

\* Normally closed (NC = b contact) solid state auto switches (D-M9□E(V)) are also available. For details, refer to page 1360.

# 10-,11-CM2X Series

## How to Order



The type which is applicable for using inside the clean room graded ISO Class 4 by making an actuator's rod section a double seal construction and discharging by relief port directly to the outside of clean room. Since the external dimensions and applicable auto switches are the same as standard type, refer to the **Web Catalog**.

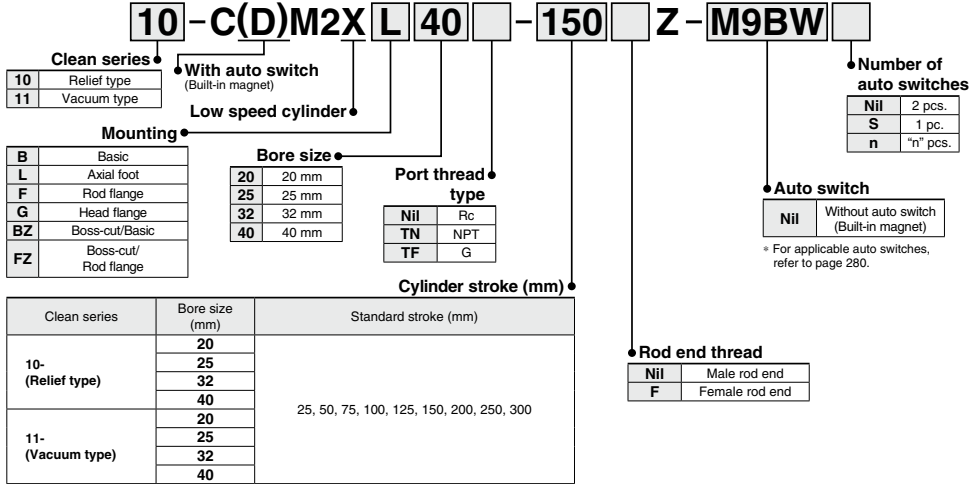

## Specifications

Bore size (mm)	10- (Relief type)				11- (Vacuum type)			
	20	25	32	40	20	25	32	40
<b>Fluid</b>	Air							
<b>Proof pressure</b>	1.5 MPa							
<b>Maximum operating pressure</b>	1.0 MPa							
<b>Minimum operating pressure</b>	0.035 MPa				0.025 MPa			
<b>Ambient and fluid temperature</b>	Without auto switch: -10°C to 70°C With auto switch: -10°C to 60°C (No freezing)							
<b>Cushion</b>	Rubber bumper							
<b>Piston speed</b>	1 to 200 mm/s				0.5 to 200 mm/s			
<b>Piston rod size</b>	ø8	ø10	ø12	ø14	ø8	ø10	ø12	ø14
<b>Rod end thread</b>	M8 x 1.25	M10 x 1.25	M14 x 1.5	M8 x 1.25	M10 x 1.25	M14 x 1.5		
<b>Stroke tolerance</b>	$^{+0.14}_0$ mm							
<b>Port size</b>	1/8		1/4		1/8		1/4	
<b>Vacuum port, Relief port</b>	M5 x 0.8							

## ⚠ Precautions

Be sure to read this before handling the products.  
 Refer to page 9 for safety instructions and pages 10 to 19 for actuator and auto switch precautions.  
 For the precautions in clean environments, refer to the **Web Catalog**.

### Operating Precautions

#### ⚠ Warning

- Do not rotate the cover.
  - When installing a cylinder or screwing a pipe fitting into the port, the coupling portion of the cover could break if the cover rotated.

#### ⚠ Caution

- Be careful of the retaining ring to pop out.
  - When replacing the rod seal, be careful of the retaining ring not to pop out while removing it.

### Maintenance

#### ⚠ Caution

- Grease pack
  - When maintenance requires only grease, use the following part number to order.

**Grease pack part number:**  
GR-X-005 (5 g)

# Low Speed Cylinder Double Acting, Single Rod **CQSX Series** ø12, ø16, ø20, ø25

## How to Order

**CQSX B 20 - 30 D**

**With auto switch CDQSX B 20 - 30 D - M9BW**

**With auto switch** (Built-in magnet)

**Low speed cylinder**

**Mounting**

<b>B</b>	Through-hole/Both ends tapped common (Standard)
<b>L</b>	Foot <sup>Note</sup>
<b>LC</b>	Compact foot
<b>F</b>	Rod flange
<b>G</b>	Head flange
<b>D</b>	Double clevis

**Bore size**

<b>12</b>	12 mm
<b>16</b>	16 mm
<b>20</b>	20 mm
<b>25</b>	25 mm

**Cylinder stroke (mm)**

Bore size	Standard stroke
<b>12, 16</b>	5, 10, 15, 20, 25, 30
<b>20, 25</b>	5, 10, 15, 20, 25, 30, 35, 40, 45, 50

**Number of auto switches**

<b>Nil</b>	2 pcs.
<b>S</b>	1 pc.
<b>n</b>	"n" pcs.

**Auto switch**

<b>Nil</b>	Without auto switch
------------	---------------------

\* For applicable auto switches, refer to the table below.

**Cushion/Rod end thread**

<b>Nil</b>	Standard (Female rod end)
<b>C</b>	With rubber bumper
<b>M</b>	Male rod end

\* Combination above is possible.

**Action**

<b>D</b>	Double acting
----------	---------------

**Built-in Magnet Cylinder Model**

If a built-in magnet cylinder without an auto switch is required, there is no need to enter the symbol for the auto switch. (Example) CDQSXL25-30D

\* Mounting bracket is shipped together with the product, (but not assembled).

\* Manufacturing of intermediate stroke  
Intermediate strokes in 1 mm increments are available by using spacers with standard stroke cylinders. The overall length of cylinder will be the same as the standard stroke with a longer one.  
Example) 3 mm width spacer is installed in the standard cylinder CQSXB25-50D to make the CQSXB25-47D.

## Applicable Auto Switches

Refer to pages 1341 to 1435 for further information on auto switches.

Type	Special function	Electrical entry	Indicator light	Wiring (Output)	Load voltage		Auto switch model		Lead wire length (m)			Pre-wired connector	Applicable load	
					DC	AC	Perpendicular	In-line	0.5 (Nil)	1 (M)	3 (L)			5 (Z)
Solid state auto switch	Diagnostic indication (2-color indicator)	Grommet	Yes	3-wire (NPN)	24 V	—	<b>M9NV</b>	<b>M9N</b>	●	●	○	○	IC circuit	
				3-wire (PNP)			<b>M9PV</b>	<b>M9P</b>	●	●	○	○		
				2-wire			<b>M9BV</b>	<b>M9B</b>	●	●	○	○		
				3-wire (NPN)			<b>M9NWX</b>	<b>M9NW</b>	●	●	○	○		
	Water resistant (2-color indicator)			3-wire (PNP)	<b>M9PWX</b>	<b>M9PW</b>	●	●	○	○	IC circuit			
				2-wire	<b>M9BWX</b>	<b>M9BW</b>	●	●	○	○				
				3-wire (NPN)	<b>M9NAV</b> <sup>*1</sup>	<b>M9NA</b> <sup>*1</sup>	○	○	●	●		IC circuit		
				3-wire (PNP)	<b>M9PAV</b> <sup>*1</sup>	<b>M9PA</b> <sup>*1</sup>	○	○	●	●				
Reed auto switch	Magnetic field resistant (2-color indicator)	Grommet	Yes	2-wire	24 V	12 V	<b>M9BAV</b> <sup>*1</sup>	<b>M9BA</b> <sup>*1</sup>	○	○	●	●	—	
				3-wire (NPN equivalent)			<b>A96V</b>	<b>A96</b>	●	●	—	—		IC circuit
				2-wire			<b>A93V</b> <sup>*2</sup>	<b>A93</b>	●	●	●	●		
No	2-wire	24 V	12 V	100 V or less	<b>A90V</b>	<b>A90</b>	●	●	—	—	—	IC circuit		

\*1 Water resistant type auto switches can be mounted on the above models, but in such case SMC cannot guarantee water resistance.

Please consult with SMC regarding water resistant types with the above model numbers.

\*2 1 m type lead wire is only applicable to D-A93.

\* Lead wire length symbols: 0.5 m ..... Nil (Example) M9NW  
1 m ..... M (Example) M9NWM  
3 m ..... L (Example) M9NLW  
5 m ..... Z (Example) M9NZL

\* Solid state auto switches marked with "C" are produced upon receipt of order.  
\*\* The D-P3DWA□ is only compatible with ø25.  
It is mounted away from the port side to avoid interference with fittings.

\* Since there are other applicable auto switches than listed, refer to page 306 for details.

\* For details about auto switches with pre-wired connector, refer to pages 1410 and 1411.

\* Auto switches are shipped together, (but not assembled).

Note) The D-A9□V/M9□V/M9□WV/M9□AV auto switches may not be mounted on the port side depending on the cylinder stroke or fitting size for piping. Please consult with SMC separately.

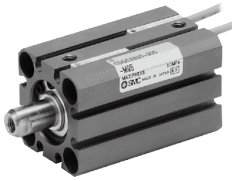

## Symbol

Single rod, Without cushion

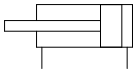

Single rod, Rubber bumper

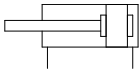

## ⚠️ Precautions

**Be sure to read this before handling the products.**

**Refer to page 9 for safety instructions and pages 10 to 19 for actuator and auto switch precautions.**

### Retaining Ring Installation/Removal

#### ⚠️ Caution

- For installation and removal, use an appropriate pair of pliers (tool for installing a type C retaining ring).
- Even if a proper plier (tool for installing type C retaining ring) is used, it is likely to inflict damage to a human body or peripheral equipment, as a retaining ring may be flown out of the tip of a plier (tool for installing a type C retaining ring). Be much careful with the popping of a retaining ring. Besides, be certain that a retaining ring is placed firmly into the groove of rod cover before supplying air at the time of installation.

### Maintenance

#### ⚠️ Caution

##### 1. Replacement parts/Seal kit

Order it in accordance with the bore size.

Bore size (mm)	Kit no.	Contents
12	CQSX12-PS	Piston seal: 1 pc.
16	CQSX16-PS	Rod seal: 1 pc.
20	CQSX20-PS	Tube gasket: 1 pc.
25	CQSX25-PS	Grease pack (10 g): 1 pc.

##### 2. Grease pack

When maintenance requires only grease, use the following part numbers to order.

##### Grease pack part number:

- GR-L-005 (5 g)
- GR-L-010 (10 g)
- GR-L-150 (150 g)

## Specifications

Bore size (mm)	12	16	20	25
Type	Pneumatic (Non-lube)			
Action	Double acting, Single rod			
Fluid	Air			
Proof pressure	1.5 MPa			
Maximum operating pressure	1.0 MPa			
Ambient and fluid temperature	Without auto switch: -10°C to 70°C With auto switch: -10°C to 60°C (No freezing)			
Cushion	None, Rubber bumper			
Rod end thread	Female thread			
Stroke length tolerance	+1.0 (Note) 0			
Piston speed	ø12, ø16: 1 to 300 mm/s ø20, ø25: 0.5 to 300 mm/s			

Note) Stroke length tolerance does not include the amount of bumper change.

## Minimum Operating Pressure

Unit: MPa

Bore size (mm)	12	16	20	25
Minimum operating pressure	0.03	0.03	0.025	0.025

## Mounting Brackets/Part No.

Bore size (mm)	Foot <sup>Note 1)</sup>	Compact foot	Flange	Double clevis
12	CQS-L012	CQS-LC012	CQS-F012	CQS-D012
16	CQS-L016	CQS-LC016	CQS-F016	CQS-D016
20	CQS-L020	CQS-LC020	CQS-F020	CQS-D020
25	CQS-L025	CQS-LC025	CQS-F025	CQS-D025

Note 1) Order two feet per cylinder.

Note 2) Parts belonging to each bracket are as follows.

Foot, Compact foot, Flange: Body mounting bolt

Double clevis: Clevis pin, Type C retaining ring for shaft, Body mounting bolt

### Mounting Bolt for CQSX/Without Auto Switch

Mounting method: Mounting bolt for through-hole mounting type of the CQSXB is available as an option.

Refer to the following for ordering procedures. Order the actual number of bolts that will be used.

**Example) CQ-M3X25L 4 pcs.**

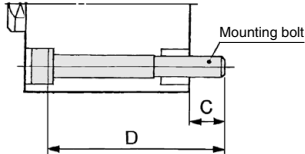

Note) The appropriate flat washer must be used for through-hole mounting.

Cylinder model	C	D	Mounting bolt part no.
<b>CQSXB12-5D</b>	6.5	25	CQ-M3X25L
<b>10D</b>		30	X30L
<b>15D</b>		35	X35L
<b>20D</b>		40	X40L
<b>25D</b>		45	X45L
<b>30D</b>		50	X50L
<b>CQSXB16-5D</b>	6.5	25	CQ-M3X25L
<b>10D</b>		30	X30L
<b>15D</b>		35	X35L
<b>20D</b>		40	X40L
<b>25D</b>		45	X45L
<b>30D</b>		50	X50L
<b>CQSXB20-5D</b>	6.5	25	CQ-M5X25L
<b>10D</b>		30	X30L
<b>15D</b>		35	X35L
<b>20D</b>		40	X40L
<b>25D</b>		45	X45L
<b>25D</b>		45	X45L

Cylinder model	C	D	Mounting bolt part no.
<b>CQSXB20-30D</b>	6.5	50	CQ-M5X50L
<b>35D</b>		55	X55L
<b>40D</b>		60	X60L
<b>45D</b>		65	X65L
<b>50D</b>		70	X70L
<b>CQSXB25-5D</b>		8.5	30
<b>10D</b>	35		X35L
<b>15D</b>	40		X40L
<b>20D</b>	45		X45L
<b>25D</b>	50		X50L
<b>30D</b>	55		X55L
<b>35D</b>	60		X60L
<b>40D</b>	65		X65L
<b>45D</b>	70		X70L
<b>50D</b>	75		X75L

Material: Chromium molybdenum steel  
Surface material: Zinc chromated

### Mounting Bolt for CDQSX/With Auto Switch

Mounting method: Mounting bolt for through-hole mounting type of the CDQSXB is available as an option.

Refer to the following for ordering procedures. Order the actual number of bolts that will be used.

**Example) CQ-M3X30L 4 pcs.**

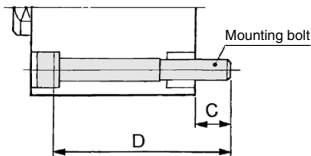

Note) The appropriate flat washer must be used for through-hole mounting.

Cylinder model	C	D	Mounting bolt part no.
<b>CDQSXB12-5D</b>	6.5	30	CQ-M3X30L
<b>10D</b>		35	X35L
<b>15D</b>		40	X40L
<b>20D</b>		45	X45L
<b>25D</b>		50	X50L
<b>30D</b>		55	X55L
<b>CDQSXB16-5D</b>	6.5	30	CQ-M3X30L
<b>10D</b>		35	X35L
<b>15D</b>		40	X40L
<b>20D</b>		45	X45L
<b>25D</b>		50	X50L
<b>30D</b>		55	X55L
<b>CDQSXB20-5D</b>	6.5	35	CQ-M5X35L
<b>10D</b>		40	X40L
<b>15D</b>		45	X45L
<b>20D</b>		50	X50L
<b>25D</b>		55	X55L
<b>25D</b>		55	X55L

Cylinder model	C	D	Mounting bolt part no.
<b>CDQSXB20-30D</b>	6.5	60	CQ-M5X60L
<b>35D</b>		65	X65L
<b>40D</b>		70	X70L
<b>45D</b>		75	X75L
<b>50D</b>		80	X80L
<b>CDQSXB25-5D</b>		8.5	40
<b>10D</b>	45		X45L
<b>15D</b>	50		X50L
<b>20D</b>	55		X55L
<b>25D</b>	60		X60L
<b>30D</b>	65		X65L
<b>35D</b>	70		X70L
<b>40D</b>	75		X75L
<b>45D</b>	80		X80L
<b>50D</b>	85		X85L

Material: Chromium molybdenum steel  
Surface material: Zinc chromated

### Accessories

For accessory bracket for the CQS series, refer to page 316, since it is commonly used with the CQ2 series.

- Single knuckle joint
- Knuckle pin
- Double knuckle joint
- Rod end nut

# CQSX Series

## Dimensions: $\phi 12$ to $\phi 25$

\* For the auto switch mounting position and its mounting height, refer to page 305.

### Standard (Through-hole/Both ends tapped common): CQSXB/CDQSXB

$\phi 12$

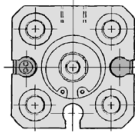

$\phi 16$

2 x 4 x  $\phi B$   
counterbore depth RB

H thread effective depth C  
2 x 4 x OA effective depth RA (Note 1)

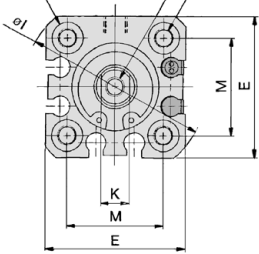

$\phi 20, \phi 25$

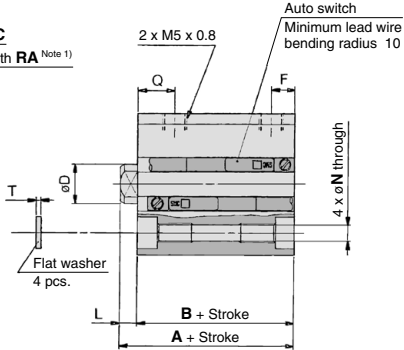

### Male rod end

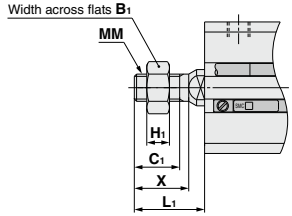
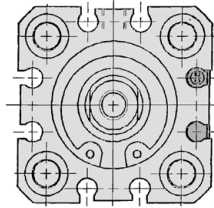

### Male Rod End (mm)

Bore size (mm)	B <sub>1</sub>	C <sub>1</sub>	H <sub>1</sub>	L <sub>1</sub>	MM	X
12	8	9	4	14	M5 x 0.8	10.5
16	10	10	5	15.5	M6 x 1.0	12
20	13	12	5	18.5	M8 x 1.25	14
25	17	15	6	22.5	M10 x 1.25	17.5

How to calculate the length with intermediate stroke  
Spacer installation type ... The dimensions will be identical to those of the nearest long stroke.

### Standard

Bore size (mm)	Standard stroke (mm)	Without auto switch		With auto switch		C	D	E	F	H	I	K	L	M	N	OA	OB	Q	RA	RB	T
		A	B	A	B																
12	5 to 30	20.5	17	25.5	22	6	6	25	5	M3 x 0.5	32	5	3.5	15.5	3.5	M4 x 0.7	6.5	7.5	7	4	0.5
16	5 to 30	20.5	17	25.5	22	8	8	29	5	M4 x 0.7	38	6	3.5	20	3.5	M4 x 0.7	6.5	7.5	7	4	0.5
20	5 to 50	24	19.5	34	29.5	7	10	36	5.5	M5 x 0.8	47	8	4.5	25.5	5.4	M6 x 1.0	9	9	10	7	1
25	5 to 50	27.5	22.5	37.5	32.5	12	12	40	5.5	M6 x 1.0	52	10	5	28	5.4	M6 x 1.0	9	11	10	7	1

Note 1) Threaded through-hole is used for the standard of  $\phi 12$  and  $\phi 16$  with a 5 mm stroke and  $\phi 20$  with 5 to 15 mm strokes and  $\phi 25$  with 5 and 10 mm strokes and  $\phi 20$  with auto switch built-in magnet with a 5 mm stroke.  
Note 2) Rubber bumper type has the same dimensions as those indicated above.  
\* For details about the rod end nut and accessory brackets, refer to page 316.



**Dimensions:  $\varnothing 12$  to  $\varnothing 25$**

**Foot: CQSXL/CDQSXL**

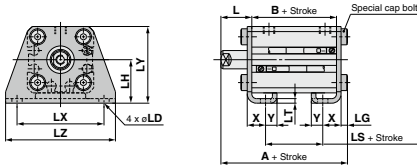

**Male rod end**

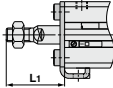

**Foot**

Bore size (mm)	Standard stroke (mm)	Without auto switch			With auto switch			L	L <sub>1</sub>
		A	B	LS	A	B	LS		
12	5 to 30	35.3	17	5	40.3	22	10	13.5	24
16	5 to 30	35.3	17	5	40.3	22	10	13.5	24
20	5 to 50	41.2	19.5	7.5	51.2	29.5	17.5	14.5	28.5
25	5 to 50	44.7	22.5	7.5	54.7	32.5	17.5	15	32.5

Bore size (mm)	LD	LG	LH	LT	LX	LY	LZ	X	Y
12	4.5	2.8	17	2	34	29.5	44	8	4.5
16	4.5	2.8	19	2	38	33.5	48	8	5
20	6.6	4	24	3.2	48	42	62	9.2	5.8
25	6.6	4	26	3.2	52	46	66	10.7	5.8

Foot bracket material: Carbon steel  
Surface treatment: Nickel plating

**Compact foot: CQSXLC/CDQSXLC**

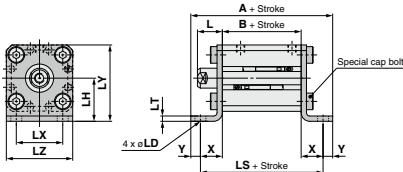

**Male rod end**

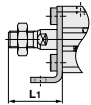

**Compact Foot**

Bore size (mm)	Stroke range (mm)	Without auto switch			With auto switch			L	L <sub>1</sub>
		A	B	LS	A	B	LS		
12	5 to 30	44.6	17	35.6	49.6	22	40.6	13.5	24
16	5 to 30	45.6	17	35.6	50.6	22	40.6	13.5	25.5
20	5 to 50	57.5	19.5	45.9	67.5	29.5	55.9	14.5	28.5
25	5 to 50	60.5	22.5	48.9	70.5	32.5	58.9	15	32.5

Bore size (mm)	LD	LH	LT	LX	LY	LZ	X	Y
12	4.5	17	2	15.5	29.5	25	9.3	4.5
16	4.5	19	2	20	33.5	29	9.3	5
20	6.6	24	3.2	25.5	42	36	13.2	5.8
25	6.6	26	3.2	28	46	40	13.2	5.8

Compact foot bracket material: Carbon steel  
Surface treatment: Zinc chromated

**Rod flange: CQSXF/CDQSXF**

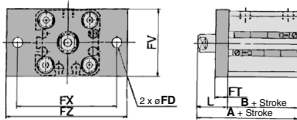

**Male rod end**

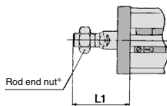

**Rod Flange**

Bore size (mm)	Standard stroke (mm)	Without auto switch		With auto switch		FD	FT	FV	FX
		A	B	A	B				
12	5 to 30	30.5	17	35.5	22	4.5	5.5	25	45
16	5 to 30	30.5	17	35.5	22	4.5	5.5	30	45
20	5 to 50	34	19.5	44	29.5	6.6	8	39	48
25	5 to 50	37.5	22.5	47.5	32.5	6.6	8	42	52

Bore size (mm)	FZ	L	L <sub>1</sub>
12	55	13.5	24
16	55	13.5	25.5
20	60	14.5	28.5
25	64	15	32.5

Flange bracket material: Carbon steel  
Surface treatment: Nickel plating

\* For details about the rod end nut and accessory brackets, refer to page 316.

# CQSX Series

Dimensions:  $\varnothing 12$  to  $\varnothing 25$

## Head flange: CQSXG/CDQSXG

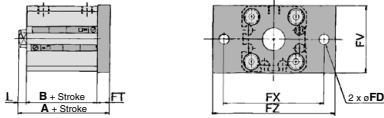

### Male rod end

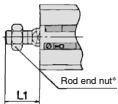

## Head Flange

Bore size (mm)	Standard stroke (mm)	Without auto switch		With auto switch	
		A	B	A	B
12	5 to 30	26	17	31	22
16	5 to 30	26	17	31	22
20	5 to 50	32	19.5	42	29.5
25	5 to 50	35.5	22.5	45.5	32.5

Bore size (mm)	FD	FT	FV	FX	FZ	L	L <sub>1</sub>
12	4.5	5.5	25	45	55	3.5	14
16	4.5	5.5	30	45	55	3.5	15.5
20	6.6	8	39	48	60	4.5	18.5
25	6.6	8	42	52	64	5	22.5

Flange bracket material: Carbon steel  
Surface treatment: Nickel plating

## Double clevis: CQSXD/CDQSXD

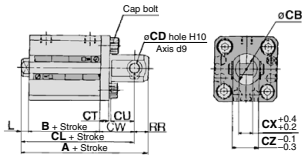

### Male rod end

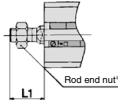

## Double Clevis

Bore size (mm)	Standard stroke (mm)	Without auto switch			With auto switch		
		A	B	CL	A	B	CL
12	5 to 30	40.5	17	34.5	45.5	22	39.5
16	5 to 30	41.5	17	35.5	46.5	22	40.5
20	5 to 50	51	19.5	42	61	29.5	52
25	5 to 50	57.5	22.5	47.5	67.5	32.5	57.5

Bore size (mm)	CB	CD	CT	CU	CW	CX	CZ	L	L <sub>1</sub>	RR
12	12	5	4	7	14	5	10	3.5	14	6
16	14	5	4	10	15	6.5	12	3.5	15.5	6
20	20	8	5	12	18	8	16	4.5	18.5	9
25	24	10	5	14	20	10	20	5	22.5	10

Double clevis bracket material: Carbon steel  
Surface treatment: Nickel plating

\* For details about the rod end nut and accessory brackets, refer to page 316.

## Simple Joint (CQSX): $\phi 12$ to $\phi 25$

### Joint/Mounting Bracket (Type A/B) Part Nos.

Bore size [mm]	Joint	Type A mounting bracket	Type B mounting bracket
12	YU-012	YA-012	YB-012
16	YU-016	YA-016	YB-016
20	YU-020	YA-020	YB-020
25	YU-025	YA-025	YB-025

<Ordering>

Joints are not included with type A or B mounting brackets. Order them separately.

(Example)

Bore size  $\phi 12$

Part no.

●Type A mounting bracket.....YA-012

●Joint.....YU-012

### Allowable Eccentricity

[mm]

Bore size [mm]	12	16	20	25
Eccentricity tolerance		$\pm 0.5$		
Axial direction backlash		0.5		

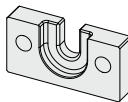
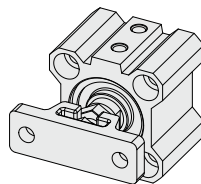

### Type A Mounting Bracket

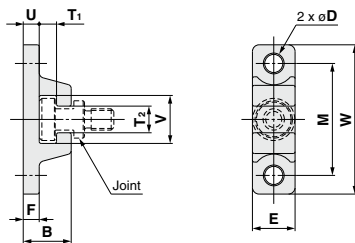

Material: Chromium molybdenum steel (Nickel plating)  
[mm]

Bore size [mm]	Part no.	B	D	E	F	M	T <sub>1</sub>	T <sub>2</sub>
12	YA-012	8	3.5	10	3	20	2.5	4
16	YA-016	8	3.5	10	3	24	2.5	5
20	YA-020	12	4.5	13	5	30	3.5	6
25	YA-025	12.5	5.5	15	5	33	3.5	7

Bore size [mm]	Part no.	U	V	W	Weight [g]
12	YA-012	3	8.5	30	9
16	YA-016	3	11	34	11
20	YA-020	5	13.5	42	27
25	YA-025	5	16.5	45	34

### Type B Mounting Bracket

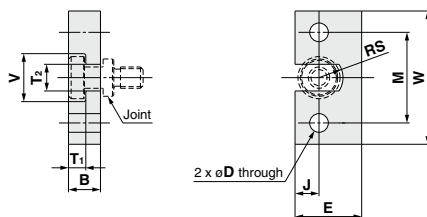

Material: Stainless steel  
[mm]

Bore size [mm]	Part no.	B	D	E	J	M	T <sub>1</sub>
12	YB-012	5	3.5	14	5	17	2.5
16	YB-016	5	3.5	16	6	20	2.5
20	YB-020	7	4.5	18	7	25.5	3.5
25	YB-025	7.5	5.5	20	8	28	3.5

Bore size [mm]	Part no.	T <sub>2</sub>	V	W	RS	Weight [g]
12	YB-012	4	8.6	25	2	11
16	YB-016	5	11	29	2.5	15
20	YB-020	6	13.6	36	3	28
25	YB-025	7	16.6	40	3.5	36

### Joint

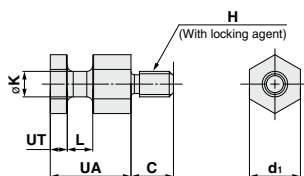

Material: Chromium molybdenum steel (Nickel plating)  
[mm]

Bore size [mm]	Part no.	UA	C	d <sub>1</sub>	H	K	L	UT	Weight [g]
12	YU-012	9.5	5	6	M3 x 0.5	3	3	2	2
16	YU-016	9.5	7	8	M4 x 0.7	4	3	2	4
20	YU-020	11.5	6	10	M5 x 0.8	5	4	3	7
25	YU-025	12	11	12	M6 x 1.0	6	4.5	3	11



# CQSX Series Auto Switch Mounting

## Minimum Stroke for Auto Switch Mounting

(mm)							
Number of auto switches	D-M9□V	D-A9□V	D-M9□WV D-M9□AV	D-A9□	D-M9□W D-M9□A	D-M9□	D-P3DWA (Note 1)
With 1 pc.	5	5	10	10 (5)	15 (10)	15 (5)	15
With 2 pcs.	5	10	10	10	15 (10)	15 (5)	15

Note 1) ø25 is only applicable for the D-P3DWA.

Note 2) The dimensions stated in ( ) shows the minimum stroke for the auto switch mounting when the auto switch does not project from the end surface of the cylinder body and hinder the lead wire bending space. (Refer to the figure on the right.)  
Order auto switches separately.

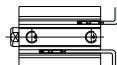

## Auto Switch Proper Mounting Position (Detection at stroke end) and Its Mounting Height

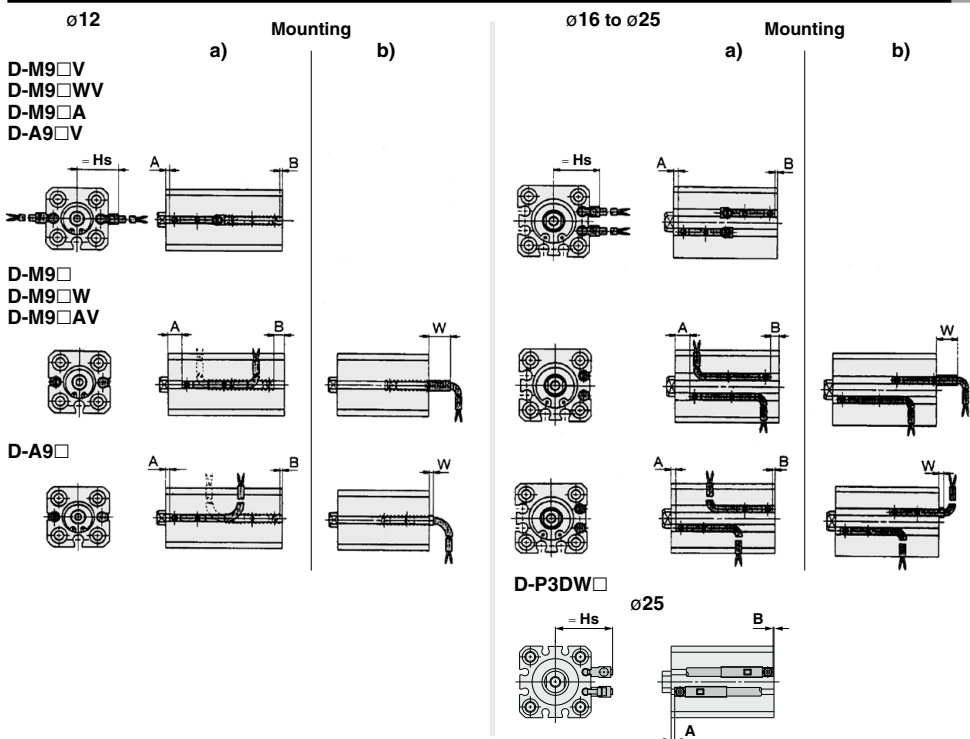

## Auto Switch Proper Mounting Position

Auto switch model		D-M9□/M9□W			D-M9□A			D-M9□V/M9□WV D-M9□AV			D-A9□			D-A9□V			D-P3DWA		
		A	B	W	A	B	W	A	B	Hs	A	B	W	A	B	Hs	A	B	Hs
Bore size	12	5.5	3.5	5.5	5.5	3.5	7.5	5.5	4.5	19.5	1.5	0	[1.5] 4	1.5	0	17	—	—	—
	16	6	4	6	6	4	8	6	4	21.5	2	0	[2] 4.5	2	0	19	—	—	—
	20	10	7.5	2.5	10	7.5	4.5	10	7.5	25	6	3.5	[-1.5] 1	6	3.5	22.5	—	—	—
	25	11	9.5	0.5	11	9.5	2.5	11	9.5	27	7	5.5	[-3.5] -1	7	5.5	24.5	6.5	5	33

[ ] : Denotes the dimensions of the D-A9□.

Note 1) Adjust the auto switch after confirming the operating condition in the actual setting.

Note 2) The product is shipped out of the factory in installation state "a)". To change the electrical entry direction of the switch on the head, refer to installation state "b)".

Note 3) Negative figures for W indicate an auto switch is mounted inward from the edge of the cylinder body.

## Operating Range

Auto switch model	Bore size (mm)			
	12	16	20	25
D-M9□/M9□V D-M9□W/M9□WV D-M9□A/M9□AV	3	4	5.5	4.5
D-A9□/A9□V	6	7.5	10	10
D-P3DWA	—	—	—	6

\* Values which include hysteresis are for guideline purposes only, they are not a guarantee (assuming approximately  $\pm 30\%$  dispersion) and may change substantially depending on the ambient environment.

### ⚠ Caution

#### Avoid proximity to magnetic objects

• If the cylinder is used in an application in which a magnetic material is placed in close contact around the cylinder as shown in the figure on the right (including cases in which even one of the sides is in close contact) the operation of auto switches could become unstable. Therefore, please consult with SMC for this type of application.

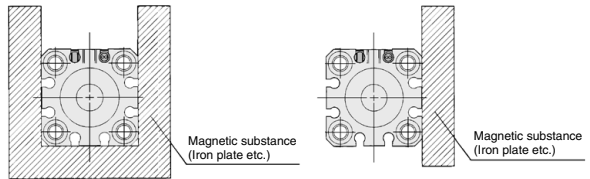

**Other than the applicable auto switches listed in “How to Order”, the following auto switches are mountable.**

\* With pre-wired connector is also available for solid state auto switches. For details, refer to pages 1410 and 1411.

\* Normally closed (NC = b contact) solid state auto switches (D-M9□E(V)) are also available. For details, refer to page 1360.



## How to Order

The type which is applicable for using inside the clean room graded ISO Class 4 by making an actuator's rod section a double seal construction and discharging by relief port directly to the outside of clean room. Since the external dimensions and applicable auto switches are the same as standard type, refer to the **Web Catalog**.

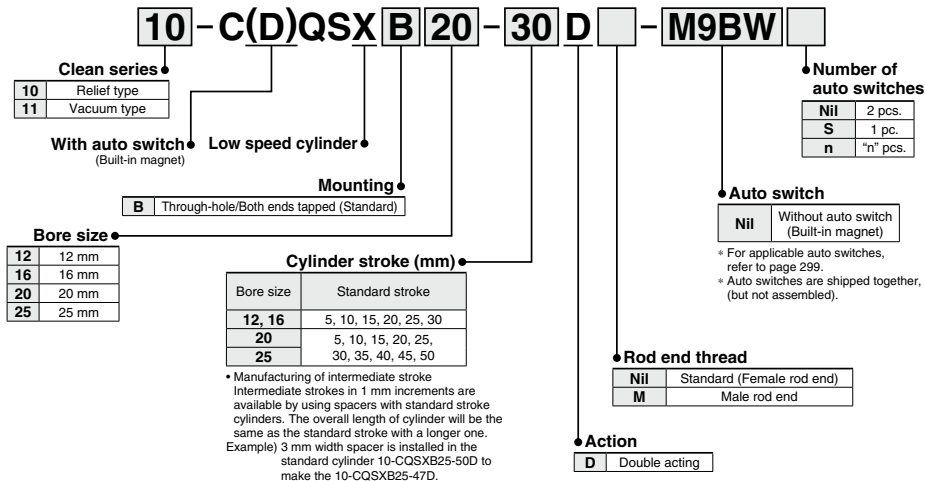

## Specifications

Bore size (mm)	10- (Relief type)				11- (Vacuum type)				
	12	16	20	25	12	16	20	25	
<b>Fluid</b>	Air				Air				
<b>Proof pressure</b>	1.5 MPa				1.5 MPa				
<b>Maximum operating pressure</b>	1.0 MPa				1.0 MPa				
<b>Minimum operating pressure</b>	0.04 MPa		0.035 MPa		0.03 MPa		0.025 MPa		
<b>Ambient and fluid temperature</b>	Without auto switch: -10°C to 70°C With auto switch: -10°C to 60°C				Without auto switch: -10°C to 70°C With auto switch: -10°C to 60°C				
<b>Piston speed</b>	1 to 200 mm/s				1 to 200 mm/s		0.5 to 200 mm/s		
<b>Piston rod size</b>	ø6	ø8	ø10	ø12	ø6	ø8	ø10	ø12	
<b>Rod end thread</b>	<b>Female thread</b>	M3 x 0.5	M4 x 0.7	M5 x 0.8	M6 x 1.0	M3 x 0.5	M4 x 0.7	M5 x 0.8	M6 x 1.0
	<b>Male thread</b>	M5 x 0.8	M6 x 1.0	M8 x 1.25	M10 x 1.25	M5 x 0.8	M6 x 1.0	M8 x 1.25	M10 x 1.25
<b>Stroke tolerance</b>	$^{+1.0}_0$ mm				$^{+1.0}_0$ mm				
<b>Port size</b>	M5 x 0.8				M5 x 0.8				
<b>Vacuum port, Relief port</b>	M5 x 0.8				M5 x 0.8				

## ⚠ Precautions

- Be sure to read this before handling the products.  
 Refer to page 9 for safety instructions and pages 10 to 19 for actuator and auto switch precautions.  
 For the precautions in clean environments, refer to the **Web Catalog**.

### Operating Precautions

#### ⚠ Warning

- Do not rotate the cover.**
  - When installing a cylinder or screwing a pipe fitting into the port, the coupling portion of the cover could break if the cover rotated.

#### ⚠ Caution

- Be careful of the retaining ring to pop out.**
  - When replacing the rod seal, be careful of the retaining ring not to pop out while removing it.

### Maintenance

#### ⚠ Caution

- Grease pack**
    - When maintenance requires only grease, use the following part number to order.
- Grease pack part number:**  
GR-X-005 (5 g)

# Low Speed Cylinder: Standard Type Double Acting, Single Rod

## CQ2X Series

ø32, ø40, ø50, ø63, ø80, ø100

### How to Order

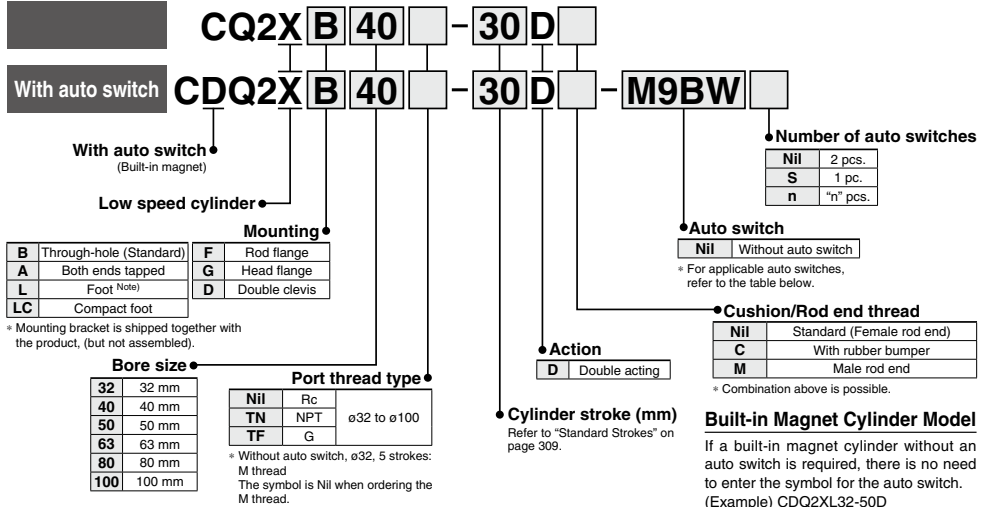

**Applicable Auto Switches**/Refer to pages 1341 to 1435 for further information on auto switches.

Type	Special function	Electrical entry	Indicator light	Wiring (Output)	Load voltage		Auto switch model		Lead wire length (m)					Pre-wired connector	Applicable load		
					DC	AC	Perpendicular	In-line	0.5 (Nil)	1 (M)	3 (L)	5 (Z)	None (N)				
Solid state auto switch	—	Grommet	No	3-wire (NPN)	5 V, 12 V	—	<b>M9NV</b>	<b>M9N</b>	●	●	○	—	—	○	IC circuit		
				3-wire (PNP)			<b>M9PV</b>	<b>M9P</b>	●	●	○	—	—	○			
		Connector	No	2-wire	12V	<b>M9BV</b>	<b>M9B</b>	●	●	○	—	—	○	—			
				—	<b>J79C</b>	—	●	●	●	●	—	—					
	Diagnostic indication (2-color indicator)	Grommet	Yes	3-wire (NPN)	5 V, 12 V	—	<b>M9NVW</b>	<b>M9NW</b>	●	●	○	—	—	○	IC circuit		
				3-wire (PNP)			<b>M9PVW</b>	<b>M9PW</b>	●	●	○	—	—	○			
				2-wire			12 V	<b>M9BW</b>	<b>M9B</b>	●	●	○	—	—		○	
		Water resistant (2-color indicator)	Grommet	No	3-wire (NPN)	5 V, 12 V	—	<b>M9NAV</b> *	<b>M9NA</b> *1	○	○	○	—	—	○	IC circuit	
					3-wire (PNP)			<b>M9PAV</b> *1	<b>M9PA</b> *1	○	○	●	○	—	—		○
					2-wire			12 V	<b>M9BAV</b> *1	<b>M9BA</b> *1	○	○	○	○	—		—
With diagnostic output (2-color indicator)	Grommet	No	4-wire	5 V, 12 V	—	—	<b>F79F</b>	●	●	○	—	—	○	IC circuit			
			2-wire (Non-polar)	—		—	<b>P3DWA</b>	—	●	●	—	—	○				
Magnetic field resistant (2-color indicator)	Grommet	No	—	—	—	—	<b>P4DW</b> **	—	●	●	—	—	○	—			
						—	—	●	●	—	—	○					
Reed auto switch	—	Grommet	Yes	3-wire (NPN equivalent)	5 V	—	<b>A96V</b>	<b>A96</b>	●	—	●	—	—	—	IC circuit		
							—	200 V	<b>A72</b>	<b>A72H</b>	●	—	●	—		—	
							12 V	100 V	<b>A93V</b> **2	<b>A93</b>	●	●	●	—		—	
		Connector	No	No	2-wire	24 V	—	5 V, 12 V	100 V or less	<b>A90V</b>	<b>A90</b>	●	—	●	—	—	IC circuit
								12 V	—	<b>A73C</b>	—	●	—	●	●	—	
								5 V, 12 V	24 V or less	<b>A80C</b>	—	●	—	●	●	—	
								—	—	<b>A79W</b>	—	●	—	●	—	—	

\*1 Water resistant type auto switches can be mounted on the above models, but in such case SMC cannot guarantee water resistance.

Please consult with SMC regarding water resistant types with the above model numbers.

\*2 1 m type lead wire is only applicable to D-A93.

\* Lead wire length symbols: 0.5 m ..... Nil (Example) M9NV  
1 m ..... M (Example) M9NVW  
3 m ..... L (Example) M9NWL  
5 m ..... Z (Example) M9NVZ  
None ..... N (Example) J79CN

\* Solid state auto switches marked with "○" are produced upon receipt of order.

\*\* The D-P4DW is compatible with ø40 to ø100.

\*\* Only the D-P4DW is assembled at the time of shipment.

\* Since there are other applicable auto switches than listed, refer to page 321 for details.

\* For details about auto switches with pre-wired connector, refer to pages 1410 and 1411.

\* When the D-A9□(V)/M9□(V)/M9□W(V)/M9□A(V) with ø32 to ø50 are mounted on a side other than the port side, order auto switch mounting brackets separately. Refer to page 320 for details.

\* Auto switches are shipped together, (but not assembled).





**Symbol**

Single rod,  
Without cushion

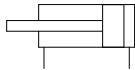

Single rod,  
Rubber bumper

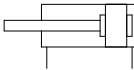

**⚠ Precautions**

Be sure to read this before handling the products. Refer to page 9 for safety instructions and pages 10 to 19 for actuator and auto switch precautions.

**Retaining Ring Installation/Removal**

**⚠ Caution**

- For installation and removal, use an appropriate pair of pliers (tool for installing a type C retaining ring).
- Even if a proper plier (tool for installing type C retaining ring) is used, it is likely to inflict damage to a human body or peripheral equipment, as a retaining ring may be flown out of the tip of a plier (tool for installing a type C retaining ring). Be much careful with the popping of a retaining ring. Besides, be certain that a retaining ring is placed firmly into the groove of rod cover before supplying air at the time of installment.

**Pneumatic Circuit**

- Pressure supplied to cylinder should be set affordably. When the operating pressure is low, low speed operation may not be stable depending on a load condition. Besides, the maximum speed may be restricted depending on a pneumatic circuit, or operating pressure.

**Maintenance**

**⚠ Caution**

**1. Replacement parts/Seal kit**

Order it in accordance with the bore size.

Bore size (mm)	Kit no.	Contents
32	CQ2X32-PS	Piston seal: 1 pc.
40	CQ2X40-PS	
50	CQSX50-PS	Rod seal: 1 pc.
63	CQ2X63-PS	Gasket: 1 pc.
80	CQ2X80-PS	
100	CQ2X100-PS	Grease pack (10 g): 1 pc.

**2. Grease pack**

When maintenance requires only grease, use the following part numbers to order.

**Grease pack part number:**

- GR-L-005 (5 g)
- GR-L-010 (10 g)
- GR-L-150 (150 g)

**Specifications**

Bore size (mm)	32	40	50	63	80	100
Type	Pneumatic (Non-lube)					
Fluid	Air					
Proof pressure	1.5 MPa					
Maximum operating pressure	1.0 MPa					
Ambient and fluid temperature	Without auto switch: -10°C to 70°C With auto switch: -10°C to 60°C (No freezing)					
Cushion	None, Rubber bumper					
Rod end thread	Female thread					
Stroke length tolerance	+1.0 mm (Note) 0					
Mounting	Through-hole					
Piston speed	0.5 to 300 mm/s					

Note) Stroke length tolerance does not include the amount of bumper change.

**Minimum Operating Pressure**

Unit: MPa

Bore size (mm)	32	40	50	63	80	100
Minimum operating pressure	0.025		0.01			

**Standard Strokes**

Bore size (mm)	Standard stroke (mm)
32, 40	5, 10, 15, 20, 25, 30, 35, 40, 45, 50, 75, 100
50, 63, 80, 100	10, 15, 20, 25, 30, 35, 40, 45, 50, 75, 100

\* Manufacturing of intermediate stroke  
Intermediate strokes in 1 mm increments are available by using spacers with standard stroke cylinders.  
Example) 18 mm width spacer is installed in the standard cylinder CQ2XB40-75D to make the CQ2XB40-57D.

**Mounting Brackets/Part No.**

Bore size (mm)	Foot <sup>Note 1)</sup>	Compact foot	Flange	Double clevis <sup>Note 3)</sup>
32	CQ-L032	CQ-LC032	CQ-F032	CQ-D032
40	CQ-L040	CQ-LC040	CQ-F040	CQ-D040
50	CQ-L050	CQ-LC050	CQ-F050	CQ-D050
63	CQ-L063	CQ-LC063	CQ-F063	CQ-D063
80	CQ-L080	CQ-LC080	CQ-F080	CQ-D080
100	CQ-L100	CQ-LC100	CQ-F100	CQ-D100

Note 1) Order two feet per cylinder.

Note 2) Parts belonging to each bracket are as follows.

Foot, Compact foot, Flange: Body mounting bolt, Double clevis: Clevis pin, Type C retaining ring for shaft, Body mounting bolt

Note 3) A clevis pin and retaining rings are included with the double clevis.

**Accessory**

For details about the single knuckle joint, double knuckle joint, knuckle pin, and rod end nut, refer to page 316.

\* Stainless steel mounting brackets and accessories are also available.

Refer to page 316 for details.

# CQ2X Series

Bore Size

## ø32 to ø50

### Standard (Through-hole) CQ2XB/ CDQ2XB

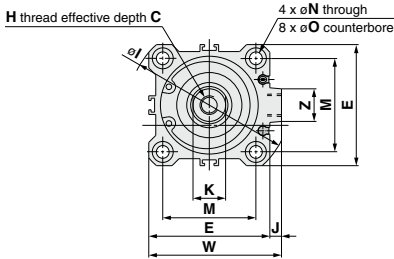

### Both ends tapped: CQ2XA/CDQ2XA

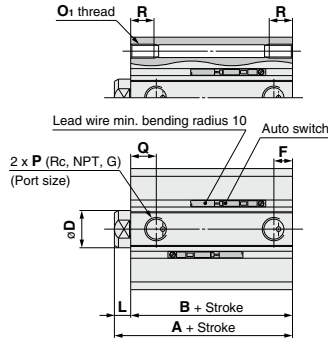

### Both Ends Tapped (mm)

Bore size (mm)	O1	R
32	M6 x 1.0	10
40	M6 x 1.0	10
50	M8 x 1.25	14

### Male rod end

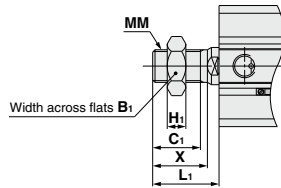

### Male Rod End (mm)

Bore size (mm)	B1	C1	H1	L1	MM	X
32	22	20.5	8	28.5	M14 x 1.5	23.5
40	22	20.5	8	28.5	M14 x 1.5	23.5
50	27	26	11	33.5	M18 x 1.5	28.5

**Standard** For the auto switch mounting position and its mounting height, refer to page 318.

(mm)

Bore size (mm)	Stroke range (mm)	Without auto switch					With auto switch					C	D	E	H	I	J	K	L	M
		A	B	F	P	Q	A	B	F	P	Q									
32	5	30	23	5.5	M5 x 0.8	11.5	40	33	7.5	1/8	10.5	13	16	45	M8 x 1.25	60	4.5	14	7	34
	10 to 50	40	33	7.5	1/8	10.5	40	33	7.5	1/8	10.5	13	16	45	M8 x 1.25	60	4.5	14	7	34
	75, 100	40	33	7.5	1/8	10.5	40	33	7.5	1/8	10.5	13	16	45	M8 x 1.25	60	4.5	14	7	34
40	5 to 50	36.5	29.5	8	1/8	11	46.5	39.5	8	1/8	11	13	16	52	M8 x 1.25	69	5	14	7	40
	75, 100	36.5	29.5	8	1/8	11	46.5	39.5	8	1/8	11	13	16	52	M8 x 1.25	69	5	14	7	40
50	10 to 50	38.5	30.5	10.5	1/4	10.5	48.5	40.5	10.5	1/4	10.5	15	20	64	M10 x 1.5	86	7	17	8	50
	75, 100	38.5	30.5	10.5	1/4	10.5	48.5	40.5	10.5	1/4	10.5	15	20	64	M10 x 1.5	86	7	17	8	50

Bore size (mm)	N	O	S	U	W	Z
32	5.5	9 depth 7	58.5	31.5	49.5	14
40	5.5	9 depth 7	66	35	57	14
50	6.6	11 depth 8	80	41	71	19

Note 1) Dimensions for rubber bumper are same as the standard type above.

\* For details about the rod end nut and accessory brackets, refer to page 316.

Note 2) Refer to page 314 for calculation of the longitudinal dimension of the intermediate strokes since there is the spacer-installed type.

Bore Size

**ø32 to ø50**

**Foot: CQ2XL/CDQ2XL**

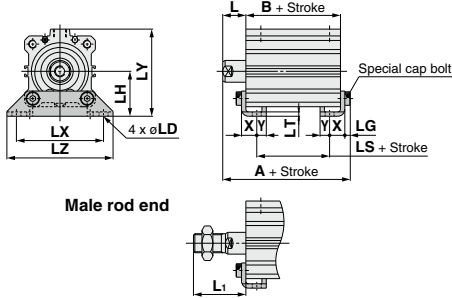

**Foot**

Bore size (mm)	Stroke range (mm)	Without auto switch			With auto switch			L	L <sub>1</sub>	LD
		A	B	LS	A	B	LS			
32	5 to 50	47.2	23	7	57.2	33	17	17	38.5	6.6
	75, 100	57.2	33	17						
40	5 to 50	53.7	29.5	13.5	63.7	39.5	23.5	17	38.5	6.6
	75, 100	63.7	39.5	23.5						
50	10 to 50	56.7	30.5	7.5	66.7	40.5	17.5	18	43.5	9
	75, 100	66.7	40.5	17.5						

Bore size (mm)	Stroke range (mm)	LG	LH	LT	LX	LY	LZ	X	Y
32	5 to 50								
	75, 100	4	30	3.2	57	57	71	11.2	5.8
40	5 to 50								
	75, 100	4	33	3.2	64	64	78	11.2	7
50	10 to 50								
	75, 100	5	39	3.2	79	78	95	14.7	8

Foot bracket material: Carbon steel  
Surface treatment: Nickel plating

**Compact foot: CQ2XLC/CDQ2XLC**

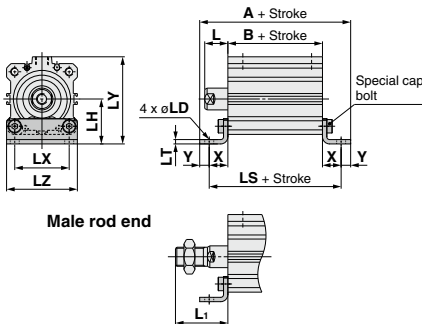

**Compact Foot**

Bore size (mm)	Stroke range (mm)	Without auto switch			With auto switch			L	L <sub>1</sub>	LD
		A	B	LS	A	B	LS			
32	5 to 50	62	23	50.4	72	33	60.4	17	38.5	6.6
	75, 100	72	33	60.4						
40	5 to 50	70.9	29.5	56.9	80.9	39.5	66.9	17	38.5	6.6
	75, 100	80.9	39.5	66.9						
50	10 to 50	79.9	30.5	63.9	89.9	40.5	73.9	18	43.5	9
	75, 100	89.9	40.5	73.9						

Bore size (mm)	Stroke range (mm)	LH	LT	LX	LY	LZ	X	Y
32	5 to 50							
	75, 100	30	3.2	34	57	45	13.7	5.8
40	5 to 50							
	75, 100	33	3.2	40	64	52	13.7	7
50	10 to 50							
	75, 100	39	3.2	50	78	64	16.7	8

Compact foot bracket material: Carbon steel  
Surface treatment: Zinc chromated

**Rod flange: CQ2XF/CDQ2XF**

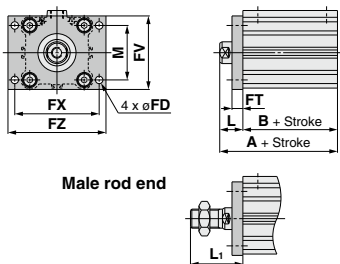

**Rod Flange**

Bore size (mm)	Stroke range (mm)	Without auto switch		With auto switch		FD	FT	FV	FX	FZ
		A	B	A	B					
32	5 to 50	40	23							
	75, 100	50	33	50	33	5.5	8	48	56	65
40	5 to 50	46.5	29.5							
	75, 100	56.5	39.5	56.5	39.5	5.5	8	54	62	72
50	10 to 50	48.5	30.5							
	75, 100	58.5	40.5	58.5	40.5	6.6	9	67	76	89

Bore size (mm)	Stroke range (mm)	L	L <sub>1</sub>	M
32	5 to 50			
	75, 100	17	38.5	34
40	5 to 50			
	75, 100	17	38.5	40
50	10 to 50			
	75, 100	18	43.5	50

Flange bracket material: Carbon steel  
Surface treatment: Nickel plating

\* For details about the rod end nut and accessory brackets, refer to page 316.

# CQ2X Series

Bore Size

## ∅32 to ∅50

### Head flange: CQ2XG/CDQ2XG

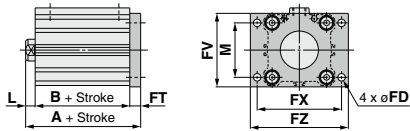

Male rod end



Applicable to { Head flange  
Double clevis

### Head Flange

Bore size (mm)	Stroke range (mm)	(mm)			
		Without auto switch		With auto switch	
		A	A	L	L1
32	5 to 50	38	48	7	28.5
	75, 100	48			
40	5 to 50	44.5	54.5	7	28.5
	75, 100	54.5			
50	10 to 50	47.5	57.5	8	33.5
	75, 100	57.5			

Flange bracket material: Carbon steel

Surface treatment: Nickel plating

(\* Dimensions except A, L and L1 are the same as rod flange type.)

### Double clevis: CQ2XD/CDQ2XD

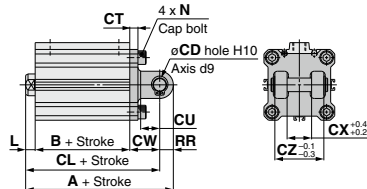

Male rod end



### Double Clevis

Bore size (mm)	Stroke range (mm)	(mm)								
		Without auto switch			With auto switch					
		A	B	CL	A	B	CL	CD	CT	CU
32	5 to 50	60	23	50	70	33	60	10	5	14
	75, 100	70	33	60						
40	5 to 50	68.5	29.5	58.5	78.5	39.5	68.5	10	6	14
	75, 100	78.5	39.5	68.5						
50	10 to 50	80.5	30.5	66.5	90.5	40.5	76.5	14	7	20
	75, 100	90.5	40.5	76.5						

Bore size (mm)	Stroke range (mm)	CW	CX	CZ	L	L1	N	RR
32	5 to 50	20	18	36	7	28.5	M6 x 1.0	10
	75, 100							
40	5 to 50	22	18	36	7	28.5	M6 x 1.0	10
	75, 100							
50	10 to 50	28	22	44	8	33.5	M8 x 1.25	14
	75, 100							

Double clevis bracket material: Cast iron

Surface treatment: Painted

\* For details about the rod end nut and accessory brackets, refer to page 316.

\*\* A double clevis pin and retaining rings are included.

Bore Size

**ø63 to ø100**

Both ends tapped: CQ2XA/CDQ2XA

Both Ends Tapped (mm)

Bore size (mm)	O <sub>1</sub>	R
63	M10 x 1.5	18
80	M12 x 1.75	22
100	M12 x 1.75	22

Standard (Through-hole)

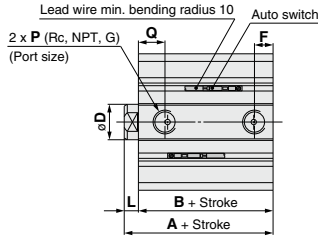
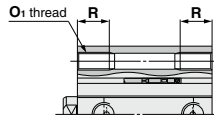
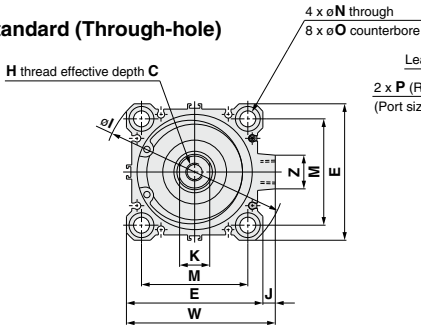

Male rod end

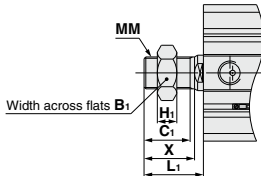

Male Rod End (mm)

Bore size (mm)	B <sub>1</sub>	C <sub>1</sub>	H <sub>1</sub>	L <sub>1</sub>	MM	X
63	27	26	11	33.5	M18 x 1.5	28.5
80	32	32.5	13	43.5	M22 x 1.5	35.5
100	41	32.5	16	43.5	M26 x 1.5	35.5

Standard For the auto switch mounting position and its mounting height, refer to page 318.

Bore size (mm)	Stroke range (mm)	Without auto switch		With auto switch		C	D	E	F	H	I	J	K	L	M	N	O	P	Q	S
		A	B	A	B															
63	10 to 50	44	36	54	46	15	20	77	10.5	M10 x 1.5	103	7	17	8	60	9	14 depth 10.5	1/4	15	93
	75, 100	54	46																	
80	10 to 50	53.5	43.5	63.5	53.5	21	25	98	12.5	M16 x 2.0	132	6	22	10	77	11	17.5 depth 13.5	3/8	16	112.5
	75, 100	63.5	53.5																	
100	10 to 50	65	53	75	63	27	30	117	13	M20 x 2.5	156	6.5	27	12	94	11	17.5 depth 13.5	3/8	23	132.5
	75, 100	75	63																	

Bore size (mm)	U	W	Z
63	47.5	84	19
80	57.5	104	26
100	67.5	123.5	26

Note 1) Dimensions for rubber bumper are same as the standard type above.  
 \* For details about the rod end nut and accessory brackets, refer to page 316.  
 Note 2) Refer to "Standard Strokes" on page 309 for calculation of the longitudinal dimension of the intermediate strokes.

# CQ2X Series

Bore Size

## Ø63 to Ø100

### Foot: CQ2XL/CDQ2XL

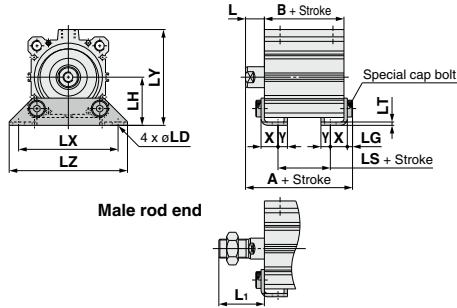

### Foot

Bore size (mm)	Stroke range (mm)	Without auto switch			With auto switch			L	L <sub>1</sub>	LD	LG	LH	LT
		A	B	LS	A	B	LS						
63	10 to 50	62.2	36	10	72.2	46	20	18	43.5	11	5	46	3.2
	75, 100	72.2	46	20									
80	10 to 50	75	43.5	13.5	85	53.5	23.5	20	53.5	13	7	59	4.5
	75, 100	85	53.5	23.5									
100	10 to 50	88	53	19	98	63	29	22	53.5	13	7	71	6
	75, 100	98	63	29									

Bore size (mm)	Stroke range (mm)	LX	LY	LZ	X	Y
63	10 to 50	95	91.5	113	16.2	9
	75, 100					
80	10 to 50	118	114	140	19.5	11
	75, 100					
100	10 to 50	137	136	162	23	12.5
	75, 100					

Foot bracket material: Carbon steel  
Surface treatment: Nickel plating

### Compact foot: CQ2XLC/CDQ2XLC

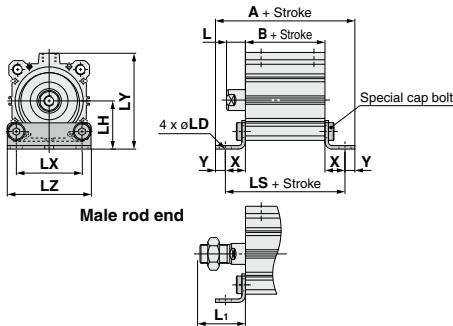

### Compact Foot

Bore size (mm)	Stroke range (mm)	Without auto switch			With auto switch			L	L <sub>1</sub>	LD
		A	B	LS	A	B	LS			
63	10 to 50	90.4	36	72.4	100.4	46	82.4	18	43.5	11
	75, 100	100.4	46	82.4						
80	10 to 50	110.5	43.5	88.5	120.5	53.5	98.5	20	53.5	13
	75, 100	120.5	53.5	98.5						
100	10 to 50	126	53	101	136	63	111	22	53.5	13
	75, 100	136	63	111						

Bore size (mm)	Stroke range (mm)	LH	LT	LX	LY	LZ	X	Y
63	10 to 50	46	3.2	60	91.5	77	18.2	9
	75, 100							
80	10 to 50	59	4.5	77	114	98	22.5	11
	75, 100							
100	10 to 50	71	6	94	136	117	24	12.5
	75, 100							

Compact foot bracket material: Carbon steel  
Surface treatment: Zinc chromated

### Rod flange: CQ2XF/CDQ2XF

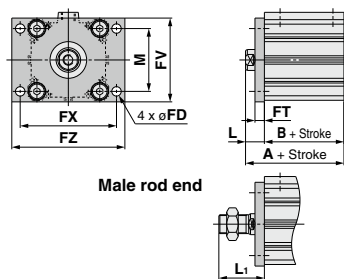

### Rod Flange

Bore size (mm)	Stroke range (mm)	Without auto switch		With auto switch		FD	FT	FV	FX	FZ	L	L <sub>1</sub>	M
		A	B	A	B								
63	10 to 50	54	36	64	46	9	9	80	92	108	18	43.5	60
	75, 100	64	46										
80	10 to 50	63.5	43.5	73.5	53.5	11	11	99	116	134	20	53.5	77
	75, 100	73.5	53.5										
100	10 to 50	75	53	85	63	11	11	117	136	154	22	53.5	94
	75, 100	85	63										

Flange bracket material: Carbon steel  
Surface treatment: Nickel plating

\* For details about the rod end nut and accessory brackets, refer to page 316.

Bore Size

**Ø63 to Ø100**

**Head flange: CQ2XG/CDQ2XG**

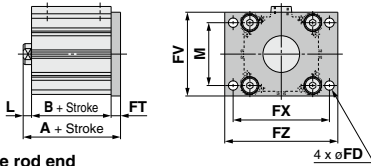

**Male rod end**

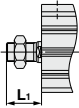

**Head Flange**

Bore size (mm)	Stroke range (mm)	Without auto switch		With auto switch		L	L <sub>1</sub>
		A	B	A	B		
63	10 to 50	53		63		8	33.5
	75, 100	63					
80	10 to 50	64.5		74.5		10	43.5
	75, 100	74.5					
100	10 to 50	76		86		12	43.5
	75, 100	86					

Flange bracket material: Carbon steel  
 Surface treatment: Nickel plating

(\* Dimensions except A, L and L<sub>1</sub> are the same as rod flange type.)

**Double clevis: CQ2XD/CDQ2XD**

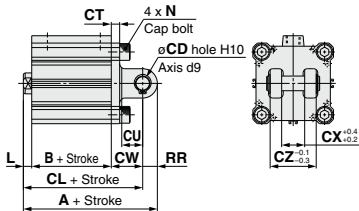

**Male rod end**

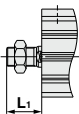

**Double Clevis**

Bore size (mm)	Stroke range (mm)	Without auto switch			With auto switch			CD	CT	CU	CW	CX
		A	B	CL	A	B	CL					
63	10 to 50	88	36	74	98	46	84	14	8	20	30	22
	75, 100	98	46	84								
80	10 to 50	109.5	43.5	91.5	119.5	53.5	101.5	18	10	27	38	28
	75, 100	119.5	53.5	101.5								
100	10 to 50	132	53	110	142	63	120	22	13	31	45	32
	75, 100	142	63	120								

Bore size (mm)	Stroke range (mm)	CZ	L	L <sub>1</sub>	N	RR
63	10 to 50	44	8	33.5	M10 x 1.5	14
	75, 100	56	10	43.5	M12 x 1.75	18
80	10 to 50	56	10	43.5	M12 x 1.75	18
	75, 100	64	12	43.5	M12 x 1.75	22
100	10 to 50	64	12	43.5	M12 x 1.75	22
	75, 100					

Double clevis bracket material: Cast iron  
 Surface treatment: Painted

\* For details about the rod end nut and accessory brackets, refer to page 316.  
 \* A double clevis pin and retaining rings are included.

## Dimensions of Accessories

### Single Knuckle Joint

For I-G012, I-Z015A  
I-G02, I-G03

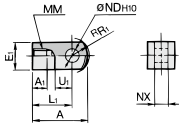

Material: Carbon steel  
Surface treatment: Nickel plating

For I-G04, I-G05  
I-G08, I-G10

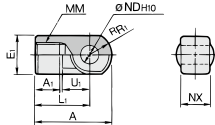

Material: Cast iron  
Surface treatment: Nickel plating (mm)

Part no.	Applicable bore size (mm)	A	A <sub>1</sub>	E <sub>1</sub>	L <sub>1</sub>	MM	<sup>h</sup> R <sub>1</sub>	U <sub>1</sub>	ND <sub>H10</sub>	NX
I-G04	32, 40	42	14	ø22	30	M14 x 1.5	12	14	10 <sup>+0.058</sup> <sub>0</sub>	18 <sup>+0.3</sup> <sub>0</sub>
I-G05	50, 63	56	18	ø28	40	M18 x 1.5	16	20	14 <sup>+0.070</sup> <sub>0</sub>	22 <sup>+0.3</sup> <sub>0</sub>
I-G08	80	71	21	ø38	50	M22 x 1.5	21	27	18 <sup>+0.070</sup> <sub>0</sub>	28 <sup>+0.3</sup> <sub>0</sub>
I-G10	100	79	21	ø44	55	M26 x 1.5	24	31	22 <sup>+0.084</sup> <sub>0</sub>	32 <sup>+0.3</sup> <sub>0</sub>

### Double Knuckle Joint

For Y-G012, Y-Z015A  
Y-G02, Y-G03

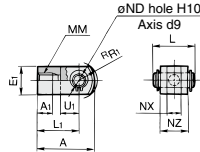

Material: Carbon steel  
Surface treatment: Nickel plating

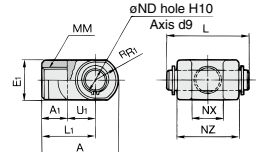

Material: Cast iron  
Surface treatment: Nickel plating (mm)

Part no.	Applicable bore size (mm)	A	A <sub>1</sub>	E <sub>1</sub>	L <sub>1</sub>	MM	<sup>h</sup> R <sub>1</sub>	U <sub>1</sub>	ND <sub>H10</sub>	NX	NZ	Applicable pin part no.
Y-G04	32, 40	42	16	ø22	30	M14 x 1.5	12	14	10 <sup>+0.058</sup> <sub>0</sub>	18 <sup>+0.3</sup> <sub>0</sub>	36	415
Y-G05	50, 63	56	20	ø28	40	M18 x 1.5	16	20	14 <sup>+0.070</sup> <sub>0</sub>	22 <sup>+0.3</sup> <sub>0</sub>	44	503
Y-G08	80	71	23	ø38	50	M22 x 1.5	21	27	18 <sup>+0.070</sup> <sub>0</sub>	28 <sup>+0.3</sup> <sub>0</sub>	56	64
Y-G10	100	79	24	ø44	55	M26 x 1.5	24	31	22 <sup>+0.084</sup> <sub>0</sub>	32 <sup>+0.3</sup> <sub>0</sub>	64	72

\* A knuckle pin and retaining rings are included.

### Knuckle Pin (Common with double clevis pin)

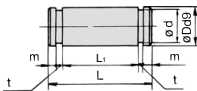

Material: Carbon steel  
(mm)

Part no.	Applicable bore size (mm)	Dd9	L	d	L <sub>1</sub>	m	t	Applicable retaining ring
IY-G04	32, 40	10 <sup>+0.040</sup> <sub>-0.016</sub>	41.6	9.6	36.2	1.55	1.15	Type C 10 for axis
IY-G05	50, 63	14 <sup>+0.050</sup> <sub>-0.023</sub>	50.6	13.4	44.2	2.05	1.15	Type C 14 for axis
IY-G08	80	18 <sup>+0.060</sup> <sub>-0.023</sub>	64	17	56.2	2.55	1.35	Type C 18 for axis
IY-G10	100	22 <sup>+0.070</sup> <sub>-0.023</sub>	72	21	64.2	2.55	1.35	Type C 22 for axis

\* Type C retaining rings for axis are included.

### Rod End Nut

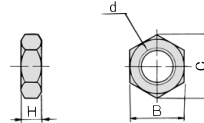

Material: Carbon steel  
Surface treatment: Nickel plating  
(mm)

Part no.	Applicable bore size (mm)	d	H	B	C
NT-04	32, 40	M14 x 1.5	8	22	25.4
NT-05	50, 63	M18 x 1.5	11	27	31.2
NT-08	80	M22 x 1.5	13	32	37.0
NT-10	100	M26 x 1.5	16	41	47.3

### Mounting Brackets, Rod End Brackets, and Nut Material: Stainless Steel

Part No. (Dimensions: Same as standard type)

Bore size (mm)	Single knuckle joint	Double knuckle joint*	Rod end nut
32	I-G04SUS	Y-G04SUS	NT-G04SUS
40			
50	I-G05SUS	Y-G05SUS	NT-05SUS
63			
80	I-G08SUS	Y-G08SUS	NT-08SUS
100			
	I-G10SUS	Y-G10SUS	NT-10SUS

\* A knuckle pin and retaining rings are shipped together. Refer to the XC27 for details on stainless steel double clevis pins and double knuckle pins. The accessories need to be ordered separately from the cylinder.



**Simple Joint (CQ2X):  $\phi 32$  to  $\phi 100$**

**Joint/Mounting Bracket (Type A/B) Part Nos.**

Bore size [mm]	Joint	Type A mounting bracket	Type B mounting bracket
<b>32, 40</b>	YU-03	YA-03	YB-03
<b>50, 63</b>	YU-05	YA-05	YB-05
<b>80</b>	YU-08	YA-08	YB-08
<b>100</b>	YU-10	YA-10	YB-10

<Ordering>  
 Joints are not included with type A or B mounting brackets. Order them separately.

(Example)

Bore size  $\phi 40$  Part no.

●Type A mounting bracket.....YA-03

●Joint.....YU-03

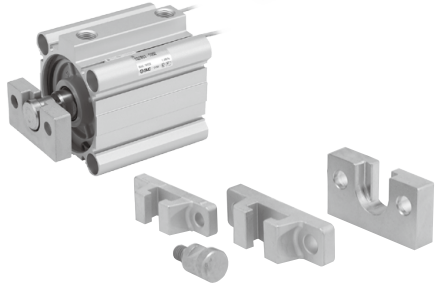

**Allowable Eccentricity**

[mm]

Bore size [mm]	32	40	50	63	80	100
Eccentricity tolerance	±1		±1.5		±2	
Axial direction backlash	0.5					

**Type A Mounting Bracket**

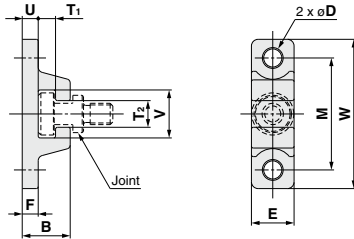

Material: Chromium molybdenum steel (Nickel plating)  
 [mm]

Bore size [mm]	Part no.	B	D	E	F	M	T <sub>1</sub>	T <sub>2</sub>
<b>32, 40</b>	<b>YA-03</b>	18	6.8	16	6	42	6.5	10
<b>50, 63</b>	<b>YA-05</b>	20	9	20	8	50	6.5	12
<b>80</b>	<b>YA-08</b>	26	11	25	10	62	8.5	16
<b>100</b>	<b>YA-10</b>	31	14	30	12	76	10.5	18

Bore size [mm]	Part no.	U	V	W	Weight [g]
<b>32, 40</b>	<b>YA-03</b>	6	18	56	55
<b>50, 63</b>	<b>YA-05</b>	8	22	67	100
<b>80</b>	<b>YA-08</b>	10	28	83	195
<b>100</b>	<b>YA-10</b>	12	36	100	340

**Type B Mounting Bracket**

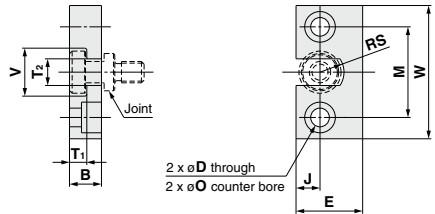

Material: Stainless steel  
 [mm]

Bore size [mm]	Part no.	B	D	E	J	M	O
<b>32, 40</b>	<b>YB-03</b>	12	7	25	9	34	11.5 depth 7.5
<b>50, 63</b>	<b>YB-05</b>	12	9	32	11	42	14.5 depth 8.5
<b>80</b>	<b>YB-08</b>	16	11	38	13	52	18 depth 12
<b>100</b>	<b>YB-10</b>	19	14	50	17	62	21 depth 14

Bore size [mm]	Part no.	T <sub>1</sub>	T <sub>2</sub>	V	W	RS	Weight [g]
<b>32, 40</b>	<b>YB-03</b>	6.5	10	18	50	9	80
<b>50, 63</b>	<b>YB-05</b>	6.5	12	22	60	11	120
<b>80</b>	<b>YB-08</b>	8.5	16	28	75	14	230
<b>100</b>	<b>YB-10</b>	10.5	18	36	90	18	455

**Joint**

YU-03, YU-05  
 YU-08, YU-10

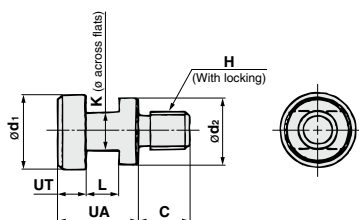

Material: Chromium molybdenum steel (Nickel plating)

Bore size [mm]	Part no.	UA	C	d <sub>1</sub>	d <sub>2</sub>	H	K	L	UT	Weight [g]
<b>32, 40</b>	<b>YU-03</b>	17	11	15.8	14	M8 x 1.25	8	7	6	25
<b>50, 63</b>	<b>YU-05</b>	17	13	19.8	18	M10 x 1.5	10	7	6	40
<b>80</b>	<b>YU-08</b>	22	20	24.8	23	M16 x 2	13	9	8	90
<b>100</b>	<b>YU-10</b>	26	26	29.8	28	M20 x 2.5	14	11	10	160

# CQ2X Series

# Auto Switch Mounting

## Auto Switch Proper Mounting Position (Detection at stroke end) and Its Mounting Height

ø32 to ø100

- D-M9□ D-M9□V
- D-M9□W D-M9□WV
- D-M9□A D-M9□AV
- D-A9□ D-A9□V

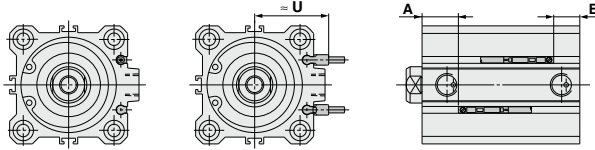

- D-A7□ D-F79F
  - D-A80 D-F7NT
  - D-A7□H D-A73C
  - D-A80H D-A80C
  - D-F7□ D-J79C
  - D-J79 D-A79W
  - D-F7□W D-F7□WV
  - D-J79W D-F7□V
- ø32 to ø100

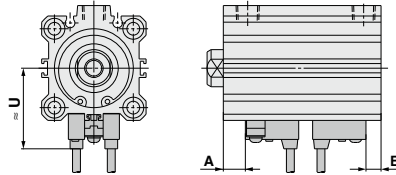

D-P3DWA ø32 to ø100

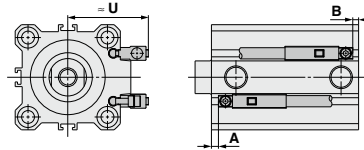

D-P4DW ø40 to ø100

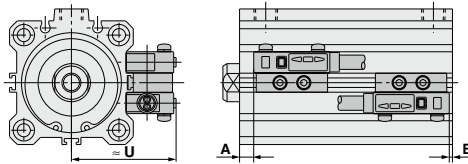

### Auto Switch Proper Mounting Position

Auto switch model	D-M9□ D-M9□V D-M9□W D-M9□WV D-M9□A D-M9□AV		D-A9□ D-A9□V		D-A7□ D-A80		D-A7□H/A80H D-A73C/A80C/F7□ D-F79F/J79/F7□V D-J79C/F7□W D-J79W/F7□WV		D-F7NT		D-A79W		D-P3DWA		D-P4DW	
	A	B	A	B	A	B	A	B	A	B	A	B	A	B	A	B
32	12	9	8	5	9	6	9.5	6.5	14.5	11.5	6.5	3.5	7.5	4.5	—	—
40	16	11.5	12	7.5	13	8.5	13.5	9	18.5	14	10.5	6	11.5	7	9	4.5
50	14	14.5	10	10.5	11	11.5	11.5	12	16.5	17	8.5	9	9.5	10	7	7.5
63	16.5	17.5	12.5	13.5	13.5	14.5	14	15	19	20	11	12	12	13	9.5	10.5
80	19.5	22	15.5	18	16.5	19	17	19.5	22	24.5	14	16.5	15	17.5	12.5	15
100	24	27	20	23	21	24	21.5	24.5	26.5	29.5	18.5	21.5	19.5	22.5	17	20

Note 1) Adjust the auto switch after confirming the operating condition in the actual setting.

Note 2) For bore sizes ø32 to ø50, the D-P3DWA is mountable only on the port side.

### Auto Switch Mounting Height

Auto switch model	D-M9□V D-M9□WV D-M9□AV		D-A9□V	D-A7□ D-A80	D-A7□H D-A80H D-F7□D-J79 D-F7□W D-J79W D-F79F D-F7NT	D-A73C D-A80C	D-F7□V D-F7□WV	D-J79C	D-A79W	D-P3DWA	D-P4DW
	U	U	U	U	U	U	U	U	U	U	U
32	29	27	31.5	32.5	38.5	35	38	34	35.5	—	—
40	32.5	30.5	35	36	42	38.5	41.5	37.5	39	44	—
50	38.5	36.5	41	42	48	44.5	47.5	43.5	45	50	—
63	42	40	47.5	48.5	54.5	51	54	50	48.5	56.5	—
80	52	50	57.5	58.5	64.5	61	64	60	58.5	66.5	—
100	62	60	67.5	68.5	74.5	71	74	70	68.5	76.5	—

## Minimum Stroke for Auto Switch Mounting

(mm)

Number of auto switches	D-M9□V D-F7□V D-J79C	D-A9□V D-A7□ D-A80 D-A73C D-A80C	D-A9□	D-M9□WV D-M9□AV D-F7□WV	D-M9□ D-F7□ D-J79	D-M9□W D-M9□A	D-A7□H D-A80H	D-A79W	D-F7□W D-J79W D-F79F D-F7NT	D-P3DWA	D-P4DW
With 1 pc.	5	5	10 (5)	10	15 (5)	15 (10)	15 (5)	15	20 (10)	15	15
With 2 pcs.	5	10	10	15	15 (5)	15	15 (10)	20	20 (15)	15	15

Note) The dimensions stated in ( ) shows the minimum stroke for the auto switch mounting when the auto switch does not project from the end surface of the cylinder body and hinder the lead wire bending space. (Refer to the figure below.)  
Order auto switches and auto switch mounting brackets separately.

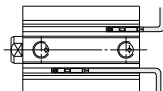

## Operating Range

(mm)

Auto switch model	Bore size					
	32	40	50	63	80	100
D-M9□(V) D-M9□W(V) D-M9□A(V)	6	5.5	6.5	7.5	7.5	8.5
D-A9□(V)	9.5	9.5	9.5	11.5	9	11.5
D-A7□(H)(C) D-A80□(H)(C)	12	11	10	12	12	13
D-A79W	13	14	14	16	15	17
D-F7□(V) D-J79(C) D-F7□W(V) D-F7NT D-F79F	6	6	6	6.5	6.5	7
D-P3DWA	6	6	7.5	6.5	6.5	7.5
D-P4DW	—	5	5	5	5	5.5

\* Values which include hysteresis are for guideline purposes only, they are not a guarantee (assuming approximately ±30% dispersion) and may change substantially depending on the ambient environment.

\* The auto switch mounting bracket BQ2-012 is not used for ø32 or more with the D-M9□(V)/M9□W(V)/M9□A(V)/A9□(V) types. The above values indicate the operating range when mounted with the current auto switch installation groove.

# CQ2X Series

## Auto Switch Mounting Brackets/Part No.

Auto switch mounting surface	Bore size (mm)	
	ø32, ø40, ø50	ø63, ø80, ø100
Auto switch model	Auto switch mounting surface	Auto switch mounting surface
	Port side	Port, A, B, C side
	<p>① BQ-2 ② BQ2-012 Two types of auto switch mounting bracket are used as a set.</p>	<p>No auto switch mounting bracket necessary.</p>
<p>D-M9□ D-M9□V D-M9□W D-M9□WV D-M9□A D-M9□AV D-A9□ D-A9□V</p>	No auto switch mounting bracket necessary.	No auto switch mounting bracket necessary.
D-P3DWA	—	—

Note 1) For the CDQ2□32 to 50, when a compact auto switch is mounted on the three sides (A, B and C above) other than the port side of bore sizes ø32 to ø50, the auto switch mounting brackets above are required. Order them separately from cylinders. (It is the same as when mounting compact cylinders with an auto switch mounting rail, but not with a compact auto switch installation groove for the CDQ2□63 to 100.)

Example

CDQ2XB32-100DM-M9BW.....1 unit

BQ-2.....2 pcs.

BQ2-012.....2 pcs.

Note 2) When the cylinder is shipped, an auto switch mounting bracket and auto switch are included in the shipment.

Auto switch model	Bore size (mm)	
	ø32	ø40 to ø100
<p>D-A7□/A80 D-A73C/A80C D-A7□H/A80H D-A79W D-F7□/J79 D-F7□V D-J79C D-F7□W/J79W D-F7□WV D-F79F/F7NT</p>		BQ-2
D-P4DW	—	BQP1-050

Note) When the cylinder is shipped, an auto switch mounting bracket and auto switch are included in the shipment. However, ø40 to ø100 with the D-P4DW are assembled at the time of shipment.

### Auto Switch Mounting Bracket Weight

Auto switch mounting bracket part no.	Applicable cylinder bore size	Weight (g)
BQ-2	ø32 to ø100	1.5
BQ6-032S	ø32 to ø100	5
BQP1-050	ø40 to ø100	16

**Other than the applicable auto switches listed in “How to Order”, the following auto switches are mountable.**

Refer to pages 1341 to 1435 for the detailed specifications.

Type	Model	Electrical entry	Features	Applicable bore size
<b>Reed</b>	D-A73	Grommet (Perpendicular)	—	ø32 to ø100
	D-A80		Without indicator light	
	D-A73H/A76H	Grommet (In-line)	—	
	D-A80H		Without indicator light	
<b>Solid state</b>	D-F7NV/F7PV/F7BV	Grommet (Perpendicular)	—	ø32 to ø100
	D-F7NWV/F7BWV		Diagnostic indication (2-color indicator)	
	D-F79/F7P/J79	Grommet (In-line)	—	
	D-F79W/F7PW/J79W		Diagnostic indication (2-color indicator)	
	D-F7NT		With timer	
	D-P5DW		Magnetic field resistant (2-color indicator)	
			ø40 to ø100	

\* With pre-wired connector is also available for solid state auto switches. For details, refer to pages 1410 and 1411.

\* Normally closed (NC = b contact) solid state auto switches (D-M9□E(V)/Y7G/Y7H) are also available. For details, refer to pages 1360 and 1362.



## How to Order

The type which is applicable for using inside the clean room graded ISO Class 4 by making an actuator's rod section a double seal construction and discharging by relief port directly to the outside of clean room. Since the external dimensions and applicable auto switches are the same as standard type, refer to the **Web Catalog**.

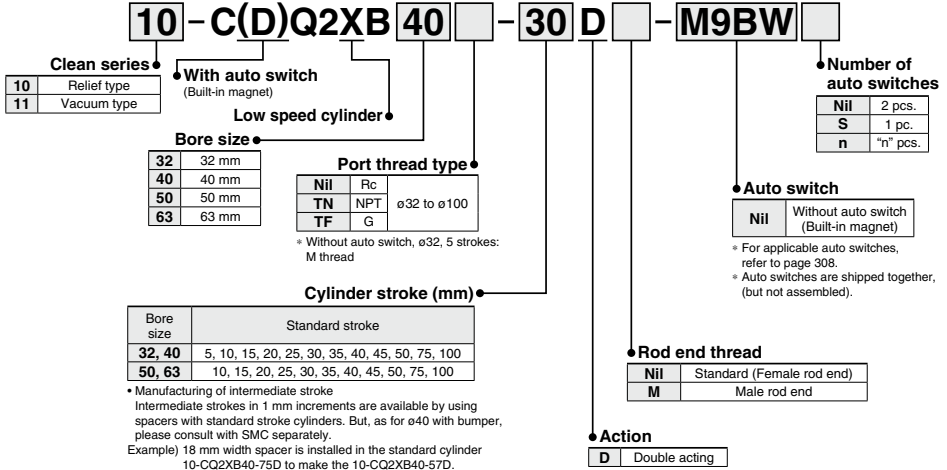

## Specifications

Bore size (mm)	10- (Relief type)				11- (Vacuum type)			
	32	40	50	63	32	40	50	63
<b>Fluid</b>	Air				Air			
<b>Proof pressure</b>	1.5 MPa				1.5 MPa			
<b>Maximum operating pressure</b>	1.0 MPa				1.0 MPa			
<b>Minimum operating pressure</b>	0.035 MPa		0.03 MPa		0.025 MPa		0.02 MPa	
<b>Ambient and fluid temperature</b>	Without auto switch: -10°C to 70°C With auto switch: -10°C to 60°C				Without auto switch: -10°C to 70°C With auto switch: -10°C to 60°C			
<b>Piston speed</b>	1 to 200 mm/s				0.5 to 200 mm/s			
<b>Piston rod size</b>	∅16		∅20		∅16		∅20	
<b>Rod end thread</b>	<b>Female thread</b>	M8 x 1.25	M10 x 1.5		M8 x 1.25	M10 x 1.5		
	<b>Male thread</b>	M14 x 1.5	M18 x 1.5		M14 x 1.5	M18 x 1.5		
<b>Stroke tolerance</b>	+1.0 0 mm				+1.0 0 mm			
<b>Port size</b>	M5 x 0.8, 1/8 (Note)		1/4		M5 x 0.8, 1/8 (Note)		1/4	
<b>Vacuum port, Relief port</b>	M5 x 0.8				M5 x 0.8			

Note) Only 5 stroke comes with M5 x 0.8 in the case of no auto switch on ∅32.

## ⚠ Precautions

Be sure to read this before handling the products.  
Refer to page 9 for safety instructions and pages 10 to 19 for actuator and auto switch precautions.  
For the precautions in clean environments, refer to the **Web Catalog**.

### Operating Precautions

#### ⚠ Warning

##### 1. Do not rotate the cover.

- When installing a cylinder or screwing a pipe fitting into the port, the coupling portion of the cover could break if the cover rotated.

#### ⚠ Caution

##### 1. Be careful of the retaining ring to pop out.

- When replacing the rod seal, be careful of the retaining ring not to pop out while removing it.

### Maintenance

#### ⚠ Caution

##### 1. Grease pack

- When maintenance requires only grease, use the following part number to order.

**Grease pack part number:**  
GR-X-005 (5 g)

# Low Speed Cylinder Double Acting, Single Rod

## CUX Series

ø10, ø16, ø20, ø25, ø32

### How to Order

**CUX 10 [ ] - 30 D**

**With auto switch CDUX 10 [ ] - 30 D - M9BW [ ]**

**With auto switch (Built-in magnet)**

**Low speed cylinder**

**Bore size**

10	10 mm
16	16 mm
20	20 mm
25	25 mm
32	32 mm

**Port thread type**

Symbol	Type	Bore size
Nil	M5 x 0.8 Rc1/8	ø10, ø16, ø20, ø25 ø32
TN	NPT1/8	ø32
TF	G1/8	ø32

**Auto switch**

Nil	Without auto switch
-----	---------------------

\* For applicable auto switches, refer to the table below.

**Action**

D	Double acting
---	---------------

**Number of auto switches**

Nil	2 pcs.
S	1 pc.

**Cylinder standard stroke (mm)**

10, 16	5, 10, 15, 20, 25, 30
20, 25, 32	5, 10, 15, 20, 25, 30, 40, 50

### Built-in Magnet Cylinder Model

If a built-in magnet cylinder without an auto switch is required, there is no need to enter the symbol for the auto switch. (Example) CDUX20-25D

### Applicable Auto Switches/Refer to pages 1341 to 1435 for further information on auto switches.

Type	Special function	Electrical entry	Indicate light	Wiring (Output)	Load voltage		Auto switch model		Lead wire length (m)			Pre-wired connector	Applicable load	
					DC	AC	Perpendicular	In-line	0.5 (Nil)	1 (M)	3 (L)			5 (Z)
Solid state auto switch	—	Grommet	Yes	3-wire (NPN)	24 V	—	M9NV	M9N	●	●	○	○	IC circuit	Relay, PLC
				3-wire (PNP)			5 V, 12 V	M9PV	M9P	●	●	○		
				2-wire	12 V	M9BV	M9B	●	●	○	○			
				3-wire (NPN)	5 V, 12 V	M9NWW	M9NW	●	●	○	○			
	Diagnostic indication (2-color indicator)			3-wire (PNP)	12 V	M9PWW	M9PW	●	●	○	○			
				2-wire	5 V, 12 V	M9BWW	M9BW	●	●	○	○			
				3-wire (NPN)	5 V, 12 V	M9NAV <sup>*1</sup>	M9NA <sup>*1</sup>	○	○	●	○			
				3-wire (PNP)	5 V, 12 V	M9PAV <sup>*1</sup>	M9PA <sup>*1</sup>	○	○	●	○			
Water resistant (2-color indicator)	2-wire	12 V	M9BAV <sup>*1</sup>	M9BA <sup>*1</sup>	○	○	●	○						
	—	Grommet	Yes	3-wire (NPN equivalent)	—	5 V	A96V	A96	●	—	—	—	IC circuit	—
				2-wire	24 V	12 V	100 V	A93V <sup>*2</sup>	A93	●	●	●	—	—
	No	2-wire	24 V	100 V or less	A90V	A90	●	●	●	—	—	IC circuit	—	

\*1 Water resistant type auto switches can be mounted on the above models, but in such case SMC cannot guarantee water resistance.

Please consult with SMC regarding water resistant types with the above model numbers.

\*2 1 m type lead wire is only applicable to D-A93.

\* Lead wire length symbols: 0.5 m ..... Nil (Example) M9NV  
 1 m ..... M (Example) M9NWM  
 3 m ..... L (Example) M9NWL  
 5 m ..... Z (Example) M9NWL

\* Solid state auto switches marked with "○" are produced upon receipt of order.

\* Since there are other applicable auto switches than listed, refer to page 327 for details.

\* For details about auto switches with pre-wired connector, refer to pages 1410 and 1411.

\* Auto switches are shipped together, (but not assembled).



## Symbol

Double acting, Single rod, Rubber bumper

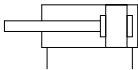

## Specifications

Bore size (mm)	10	16	20	25	32
<b>Fluid</b>	Air				
<b>Proof pressure</b>	1.05 MPa				
<b>Maximum operating pressure</b>	0.7 MPa				
<b>Ambient and fluid temperature</b>	Without auto switch: -10°C to 70°C With auto switch: -10°C to 60°C (No freezing)				
<b>Lubrication</b>	Not required (Non-lube)				
<b>Piston speed</b>	ø10, ø16: 1 to 300 mm/s ø20 to ø32: 0.5 to 300 mm/s				
<b>Cushion</b>	Rubber bumper on both ends				
<b>Rod end thread</b>	Male thread				
<b>Stroke length tolerance</b>	+1.0 (Note) 0				
<b>Mounting</b>	Basic				

Note) Tolerance  $^{+1.0}_0$

## Minimum Operating Pressure

Bore size (mm)	10	16	20	25	32
Minimum operating pressure	0.06	0.06	0.05	0.05	0.05

Unit: MPa

## Standard Strokes

Bore size (mm)	Standard stroke (mm)
10, 16	5, 10, 15, 20, 25, 30
20, 25, 32	5, 10, 15, 20, 25, 30, 40, 50

## ⚠ Precautions

Be sure to read this before handling the products.  
Refer to page 9 for safety instructions and pages 10 to 19 for actuator and auto switch precautions.

### Mounting

#### ⚠ Caution

- Tightening the cylinder beyond the range of the indicated torque (shown in the table below) may affect operation. Apply a Loctite® (no. 242, Blue) to the mounting threads.

Bore size (mm)	Hexagon socket head (mm)	Proper tightening torque (N·m) (Cylinder body)
10	M3	0.54 ±10%
16	M4	1.23 ±10%
20, 25	M5	2.55 ±10%
32	M6	4.02 ±10%

### Operating Precautions

#### ⚠ Warning

- It might not be able to control the CUX10 by meter-out at a low speed operation.

#### ⚠ Caution

- For the CUX10, up to 0.1 N L/min (ANR) of internal leakage is anticipated due to cylinder structure.

### Maintenance

#### ⚠ Caution

##### 1. Replacement parts/Seal kit

Order it in accordance with the bore size.

Bore size (mm)	Kit no.	Contents
16	CUX16-PS	Piston seal: 1 pc. Rod seal: 1 pc.
20	CUX20-PS	
25	CUX25-PS	Gasket: 1 pc.
32	CUX32-PS	

\* It is impossible to replace seals in bore size 10 mm.

##### 2. Grease pack

Use the following part numbers to order maintenance grease.

**Grease pack part number:**

**GR-L-005** (5 g)

**GR-L-010** (10 g)

**GR-L-150** (150 g)



**Dimensions: Double Acting, Single Rod**

ø10

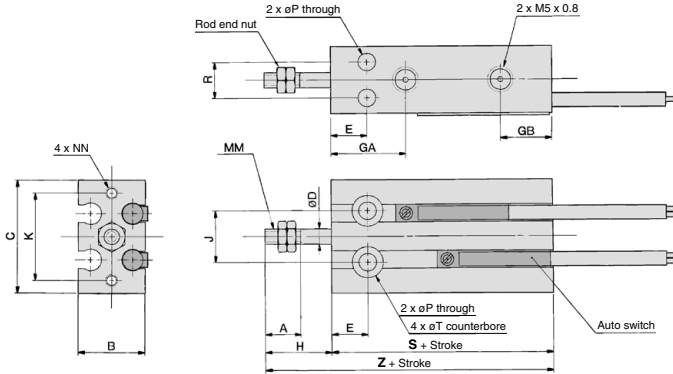

ø16 to ø32

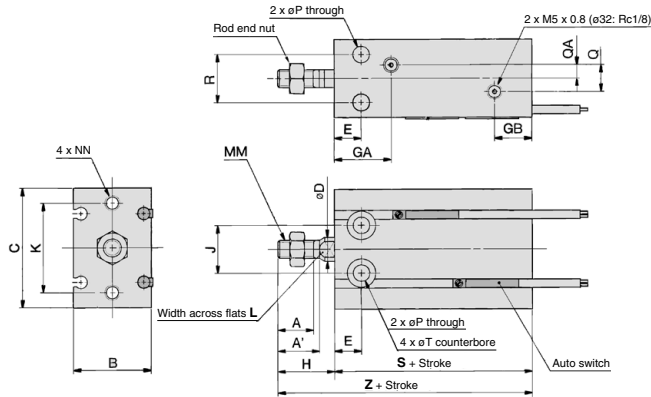

**Rod End Nut/Accessories**

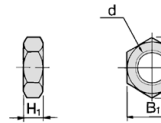

Material: Carbon steel

Part no.	Applicable bore size (mm)	d	H <sub>1</sub>	B <sub>1</sub>	C <sub>1</sub>
<b>NTP-010</b>	<b>10</b>	M4 x 0.7	2.4	7	8.1
<b>NTJ-015A</b>	<b>16</b>	M5 x 0.8	4	8	9.2
<b>NT-015A</b>	<b>20</b>	M6 x 1.0	5	10	11.5
<b>NT-02</b>	<b>25</b>	M8 x 1.25	5	13	15.0
<b>NT-03</b>	<b>32</b>	M10 x 1.25	6	17	19.6

Bore size (mm)	(mm)																
	A	A'	B	C	D	E	GA	GB	H	J	K	L	MM	NN	P	Q	QA
10	10	—	15	24	4	7	16.5	10	16	11	18	—	M4 x 0.7	M3 x 0.5 depth 5	3.2	—	—
16	11	12.5	20	32	6	7	16.5 <sup>Note</sup>	11.5	16	14	25	5	M5 x 0.8	M4 x 0.7 depth 6	4.5	4	2
20	12	14	26	40	8	9	19	12.5	19	16	30	6	M6 x 1.0	M5 x 0.8 depth 8	5.5	9	4.5
25	15.5	18	32	50	10	10	21.5	13	23	20	38	8	M8 x 1.25	M5 x 0.8 depth 8	5.5	9	4.5
32	19.5	22	40	62	12	11	23	12.5	27	24	48	10	M10 x 1.25	M6 x 1.0 depth 9	6.6	13.5	4.5

Bore size (mm)	R	T	Without auto switch		With auto switch	
			S	Z	S	Z
10	9	6 depth 5	36	52	36	52
16	12	7.6 depth 6.5	30	46	40	56
20	16	9.3 depth 8	36	55	46	65
25	20	9.3 depth 9	40	63	50	73
32	24	11 depth 11.5	42	69	52	79

Note) 5 stroke (CUX16-5D): 14.5 mm

# CUX Series

## Auto Switch Mounting

### Auto Switch Proper Mounting Position (Detection at stroke end) and Its Mounting Height

D-M9□  
 D-M9□W  
 D-M9□A  
 D-A9□

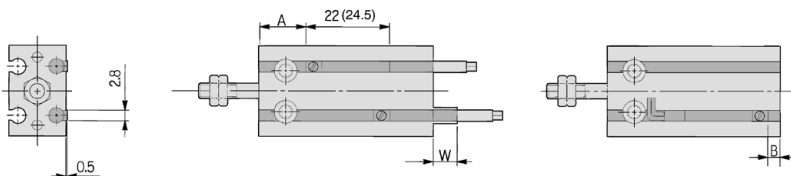

( ) : Dimension of the D-A9□

D-M9□V  
 D-M9□WV  
 D-M9□AV  
 D-A9□V

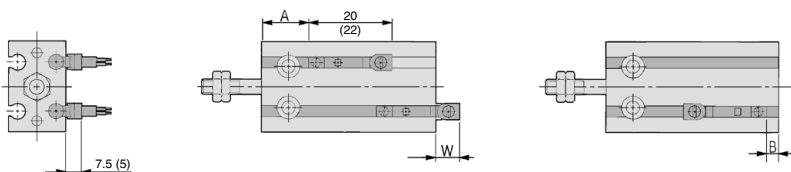

( ) : Dimension of the D-A9□V

### CDUX Double Acting, Single Rod

(mm)

Bore size (mm)	D-M9□, D-M9□W			D-M9□V, D-M9□WV			D-M9□A			D-M9□AV			D-A9□, D-A9□V		
	A	B	W	A	B	W	A	B	W	A	B	W	A	B	W
10	16.5	7.5	2.5	16.5	7.5	0.5	16.5	7.5	4.5	16.5	7.5	2.5	12.5	3.5	(-1.5)1
16	20	8	1.5	20	8	-0.5	20	8	3.5	20	8	1.5	16	4	(-2)0.5
20	24	10	0	24	10	-2	24	10	2	24	10	0	20	6	(-4)-1.5
25	26.5	11	-1.5	26.5	11	-3.5	26.5	11	0.5	26.5	11	-1.5	22.5	7	(-5.5)-3
32	27.5	12.5	-2.5	27.5	12.5	-4.5	27.5	12.5	-0.5	27.5	12.5	-2.5	23.5	8.5	(-6.5)-4

Note 1) Figures in the table above are used as a reference when mounting the auto switches for stroke end detection.

Adjust the auto switch after confirming the operating condition in the actual setting.

Note 2) Negative figures in the table W indicate an auto switch is mounted inward from the edge of the cylinder body.

Note 3) In the case of the 5 stroke or the 10 stroke, there are times in which the auto switch will not turn OFF or 2 auto switches will turn ON simultaneously due to their movement range. Therefore, set the position approximately 1 to 4 mm outward from the values given in the table above. Then, perform an operation inspection to make sure that the auto switches operate normally (if 1 auto switch is used, make sure that it turns ON and OFF properly; if 2 auto switches are used, make sure that both auto switches turn ON).

Note 4) ( ) in column W is the dimensions of the D-A9□.

### Operating Range

(mm)

Auto switch model	Bore size				
	10	16	20	25	32
D-M9□, M9□V D-M9□W, M9□WV D-M9□A, M9□AV	4	5.5	7	7	7.5
D-A9□, A9□V	6	9	11	12.5	14

\* Values which include hysteresis are for guideline purposes only, they are not a guarantee (assuming approximately ±30% dispersion) and may change substantially depending on the ambient environment.

**Caution on Proximity Installation**

When free mounting cylinders equipped with auto switches are used, the auto switches could activate unintentionally if the installed distance is less than the dimensions shown in the table. Therefore, make sure to provide a greater clearance. Due to unavoidable circumstances, if they must be used with less distance than the dimensions given in the table, the cylinders must be shielded. Therefore, affix a steel plate or a magnetic shielding plate (MU-S025) to the area on the cylinder that corresponds to the adjacent auto switch. (Please contact SMC for details.) Auto switches may malfunction if a shield plate is not used.

Dimensions of shielding plate (MU-S025) that is sold separately are indicated as reference.

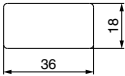

Material: Ferrite stainless steel, Thickness: 0.3 mm  
 Since the back side is treated with adhesive, it is possible to attach to the cylinder.

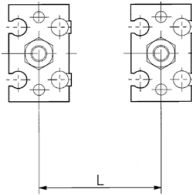

Bore size (mm)	Mounting pitch L (mm)
10	30
16	33
20	40
25	46
32	56

**Other than the applicable auto switches listed in “How to Order”, the following auto switches are mountable.**

\* Normally closed (NC = b contact) solid state auto switches (D-M9□E(V)) are also available. For details, refer to page 1360.



# Smooth Cylinders/Low Speed Cylinders Specific Product Precautions 1

Be sure to read this before handling the products. Refer to page 9 for safety instructions and pages 10 to 19 for actuator and auto switch precautions.

## Recommended Pneumatic Circuit

### Warning

#### Horizontal Operation

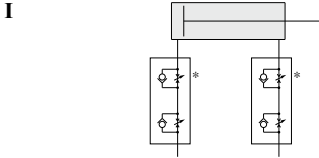

#### Dual speed controller

Speed is controlled by meter-out circuit. Using concurrently the meter-in circuit can alleviate the stick-slip. More stable low speed operation can be achieved than meter-in circuit alone.

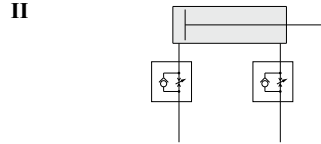

#### Meter-in speed controller

Meter-in speed controllers can reduce lurching while controlling the speed. The two adjustment needles facilitate adjustment.

#### Vertical Operation

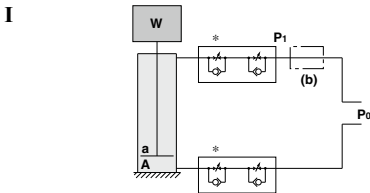

- (1) Speed is controlled by meter-out circuit. Using concurrently the meter-in circuit can alleviate the stick-slip.\*
- (2) Depending on the size of the load, installing a regulator with check valve at position (b) can reduce lurching during descent and operation delay during ascent.  
As a guide,  
when  $W + P_0a > P_0A$ ,  
adjust  $P_1$  to make  $W + P_1a = P_0A$ .

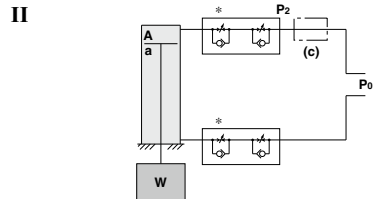

- (1) Speed is controlled by meter-out circuit. Using concurrently the meter-in circuit can alleviate the stick-slip.\*
- (2) Installing a regulator with check valve at position (c) can reduce lurching during descent and operation delay during ascent.  
As a guide,  
adjust  $P_2$  to make  $W + P_2A = P_0A$ .

**W:** Load (N)   **P<sub>0</sub>:** Operating pressure (MPa)   **P<sub>1</sub>, P<sub>2</sub>:** Reduced pressure (MPa)   **a:** Rod side piston area (mm<sup>2</sup>)   **A:** Head side piston area (mm<sup>2</sup>)

### Warning

Since the low speed cylinder **C□UX10** is subject to internal leakage due to its construction, the speed may not be fully controlled with the meter-out controller (\*) during low speed operation.



# Smooth Cylinders/Low Speed Cylinders Specific Product Precautions 2

Be sure to read this before handling the products. Refer to page 9 for safety instructions and pages 10 to 19 for actuator and auto switch precautions.

## Design

### ⚠ Caution

- 1. Provide a construction that does not apply a lateral load to the cylinder.**  
Applying a lateral load to the cylinder may cause a malfunction. (Only for low speed cylinders)
- 2. Design the system to prevent vibration from being applied to the cylinder.**  
A malfunction may occur due to the vibration.
- 3. Avoid using a guide with obvious variations in operating resistance.**  
Operation may become unstable when using a guide that manifests variations in operating resistance, or when the external load changes.
- 4. Avoid a system structure in which the mounting orientation changes.**  
Operation may become unstable if the mounting orientation changes.
- 5. Avoid operation where the temperature fluctuates greatly. Also, when using at low temperatures, make sure that frost does not form inside the cylinder and on the piston rod.**  
Operation may become unstable.
- 6. Do not use the product at a high frequency.**  
Use it at 30 cpm or less as a guideline.
- 7. Adjust the speed in accordance with the operating environment.**  
When the operating environment changes, the speed adjustment will be off unless it is reset to reflect operation in the new environment.
- 8. For cylinders with long strokes, sliding resistance will increase due to the deflection of the piston rod and other factors. Take measures such as the installation of a guide. (Only for smooth cylinders)**
- 9. Do not apply excessive lateral load to the piston rod. (Only for smooth cylinders) <sup>Note 1)</sup>**  
Note 1) Easy checking method  
Minimum operating pressure after the cylinder is mounted to the equipment (MPa) = Minimum operating pressure of cylinder (MPa) + {Load weight (kg) x Friction coefficient of guide/Sectional area of cylinder (mm<sup>2</sup>)}  
If smooth operation is confirmed within the above value, the load on the cylinder is the resistance of the thrust only and it can be judged as having no lateral load.

## Pneumatic Circuit

### ⚠ Caution

- 1. The piping length between the speed controller and the cylinder port must be kept as short as possible.**  
If the speed controller and the cylinder port are far apart, speed adjustment may be unstable.
- 2. Use a speed controller for low speed operation to easily adjust for low speed operation or a dual speed controller (ASD series) to prevent cylinders from popping out.**  
(When the speed controller for low speed operation is used, the maximum speed may be limited.)  
Refer to "Recommended Pneumatic Circuit" on page 328.

## Mounting

### ⚠ Caution

- 1. Do not apply a lateral load to the piston rod.**  
Applying a lateral load to the piston rod may cause a malfunction. (Only for low speed cylinders)
- 2. Do not apply excessive lateral load to the piston rod. (Only for smooth cylinders) <sup>Note 1)</sup>**  
Note 1) Easy checking method  
Minimum operating pressure after the cylinder is mounted to the equipment (MPa) = Minimum operating pressure of cylinder (MPa) + {Load weight (kg) x Friction coefficient of guide/Sectional area of cylinder (mm<sup>2</sup>)}  
If smooth operation is confirmed within the above value, the load on the cylinder is the resistance of the thrust only and it can be judged as having no lateral load.

## Lubrication

### ⚠ Caution

- 1. Operate without lubrication from a pneumatic system lubricator.**  
A malfunction may occur when lubricated in this fashion.
- 2. Only use the grease recommended by SMC.**  
The low speed cylinder and the low speed cylinder with clean room specifications use different types of grease. The use of grease other than the specified type can cause a malfunction and particulate generation.  
• Order using the following part numbers when only maintenance grease is needed.

#### Grease

Volume	Part no.
5 g	GR-L-005
10 g	GR-L-010
150 g	GR-L-150

- 3. Do not wipe out the grease in the sliding part of the air cylinder.**  
Doing so may cause a malfunction.

## Air Supply

### ⚠ Caution

- 1. Take measures to prevent pressure fluctuation.**  
A malfunction may occur with the fluctuation of pressure.