

Compact Guide Cylinder

MGP Series

ø12, ø16, ø20, ø25, ø32, ø40, ø50, ø63, ø80, ø100

Up to
24%
Weight
reduced!

Weight reduced by up to 24% with
a shorter guide rod and thinner plate



3 types of bearing
can be selected.

● Slide bearing

MGPM series

● Ball bushing

MGPL series

● High precision ball bushing

MGPA series



Guide rod shortened
for MGP40-25 stroke

Max. **22** mm

Space required between the
bottom of the cylinder body and
your equipment is reduced.

Space saving



With air cushion

Water resistant cylinder

3 types of bearing can be selected.

Slide bearing
MGPM series

Suitable for lateral load applications such as a stopper where shock is applied

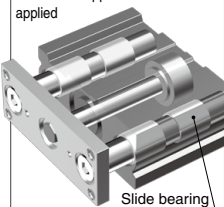

Slide bearing

Ball bushing
MGPL series

Smooth operation suitable for pusher and lifter

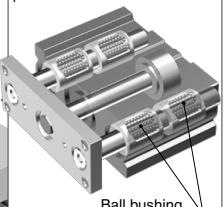

Ball bushing

High precision ball bushing
MGPA series

Suitable for minimizing plate displacement

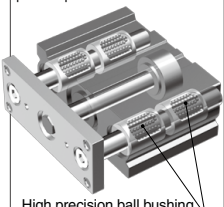

High precision ball bushing

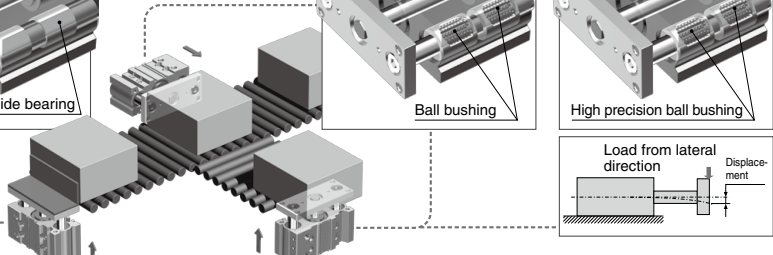

Load from lateral direction

Displacement

Basic Type

- **Weight reduced by up to 17%** ● **Guide rod shortened**

Bore size [mm]	Reduction rate [%]	Weight [kg]
ø12	11	0.25
ø16	3	0.37
ø20	12	0.59
ø25	12	0.84
ø32	17	1.41
ø40	16	1.64
ø50	17	2.79
ø63	17	3.48
ø80	17	5.41
ø100	13	9.12

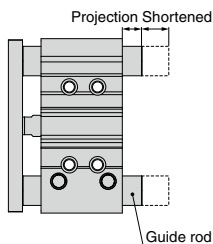

Bore size	Guide rod [mm]	
	Shortened by	New dimension
ø32	22	15.5
ø40	22	9
ø50	18	16.5
ø63	18	11.5
ø80	10.5	8
ø100	10.5	10.5

*: Compared with the slide bearing type, 25 stroke (ø32 to ø100)
(No projection for ø12 to ø25-25 stroke)

※: Compared with the slide bearing type, ø12 to ø25-20 stroke
※: Compared with the slide bearing type, ø32 to ø100-25 stroke

- **Performance and strength (rigidity) are equivalent to the current MGP series.**
● **Mounting dimensions are equivalent to the current MGP series.**

MGP Series (Basic Type), Stroke Variations

Bearing type	Bore size [mm]	Stroke [mm]																Made to Order		
		10	20	25	30	40	50	75	100	125	150	175	200	250	300	350	400			
MGPM Slide bearing	12	●																	-XA□: Change of guide rod end shape -XB6: Heat resistant cylinder (-10 to 150°C) -XB10: Intermediate stroke (Using exclusive body) -XB13: Low speed cylinder (5 to 50 mm/s) -XC6: Made of stainless steel -XC8: Adjustable stroke cylinder/ Adjustable extension type -XC22: Fluororubber seal -XC35: With coil scraper -XC79: Tapped hole, drilled hole and pinned hole machined additionally -XC82: Bottom mounting type -X144: Symmetrical port position -X867: Side porting type (Plug location changed)	
	16	●	●																	
	20	●	●	●																
	25	●	●	●	●															
MGPL Ball bushing	32			●	●	●	●	●	●	●	●	●	●	●	●	●	●	●		
	40			●	●	●	●	●	●	●	●	●	●	●	●	●	●	●		
	50			●	●	●	●	●	●	●	●	●	●	●	●	●	●	●		
MGPA High precision ball bushing	63			●	●	●	●	●	●	●	●	●	●	●	●	●	●	●		
	80			●	●	●	●	●	●	●	●	●	●	●	●	●	●	●		
	100			●	●	●	●	●	●	●	●	●	●	●	●	●	●	●		

※: For details, refer to pages 597 and 1419 to 1585.

Small auto switches or magnetic field resistant auto switches can be directly mounted on **2 surfaces**.

- D-M9□
- D-A9□
- D-P3DWA

*: The D-Y7 and D-Z7 auto switches are not mountable.

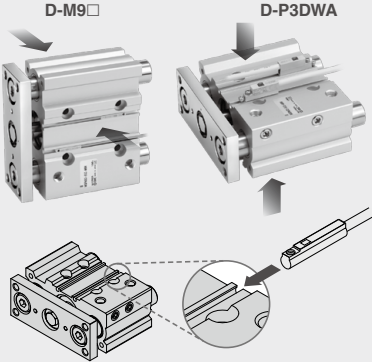

4 types of mounting are possible.

Easy positioning
Knock pin holes provided on each mounting surface

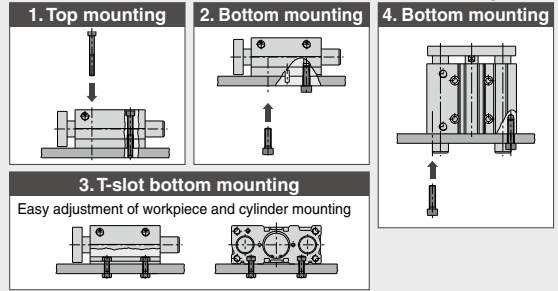

Piping is possible from **2 directions**.

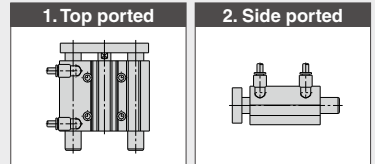

With Air Cushion

● **Weight reduced by up to 24%**

Bore size [mm]	Reduction rate [%]	Weight [kg]
φ16	12	1.28
φ20	18	1.91
φ25	22	2.52
φ32	24	3.57
φ40	23	4.13
φ50	23	6.56
φ63	22	8.04
φ80	21	11.35
φ100	19	17.72

*: Compared with the current MGPM with air cushion, 200 stroke

● **Guide rod shortened by up to 35.5 mm** (MGPM100-50 stroke) [mm]

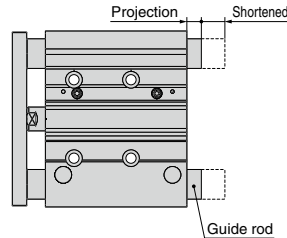

Bore size	Guide rod	
	Shortened by	New dimension
φ32	33.5	9
φ40	33.5	2.5
φ50	22	12.5
φ63	22	7.5
φ80	35.5	10
φ100	35.5	10.5

*: Compared with the current MGPM with air cushion, 50 stroke

- Performance and strength are equivalent to the current MGP series with air cushion.
- Mounting dimensions are equivalent to the current MGP series with air cushion.

MGP Series (With Air Cushion), Stroke Variations

Bearing type	Bore size [mm]	Stroke [mm]												Made to Order	
		25	50	75	100	125	150	175	200	250	300	350	400		
MGPM-□A Slide bearing	16	●	●	●	●	●	●	●	●	●	●	●	●	●	-XC19: Intermediate stroke (Spacer type)
	20	●	●	●	●	●	●	●	●	●	●	●	●	●	
	25	●	●	●	●	●	●	●	●	●	●	●	●	●	
MGPL-□A Ball bushing	32	●	●	●	●	●	●	●	●	●	●	●	●	●	-XC79: Tapped hole, drilled hole, pinned hole machined additionally
	40	●	●	●	●	●	●	●	●	●	●	●	●	●	
	50	●	●	●	●	●	●	●	●	●	●	●	●	●	
MGPA-□A High precision ball bushing	63	●	●	●	●	●	●	●	●	●	●	●	●	●	-X867: Side porting type (Plug location changed)
	80	●	●	●	●	●	●	●	●	●	●	●	●	●	
	100	●	●	●	●	●	●	●	●	●	●	●	●	●	
	100	●	●	●	●	●	●	●	●	●	●	●	●	●	

*: For details, refer to pages 597 and 1419 to 1585.

With End Lock

- Holds the cylinder's home position even if the air supply is cut off.
- Compact body $\varnothing 20$ to $\varnothing 63$ Standard + 25 mm body length
 $\varnothing 80$, $\varnothing 100$ Standard + 50 mm body length

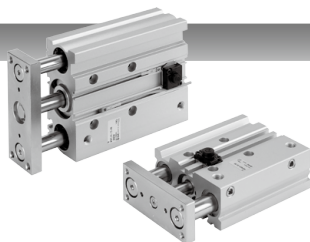

Stroke Variations

Bearing type	Bore size [mm]	Stroke [mm]										Intermediate stroke	Lock direction	Manual release		
		25	50	75	100	125	150	175	200	250	300				350	400
MGPM Slide bearing	20	●	●	●	●	●	●	●	●	●	●	●	●	Spacer type available in 5 mm stroke increments.	Rod end lock	Non-lock type
	25	●	●	●	●	●	●	●	●	●	●	●	●			
MGPL Ball bushing bearing	32	●	●	●	●	●	●	●	●	●	●	●	●			
	40	●	●	●	●	●	●	●	●	●	●	●	●			
MGPA High precision ball bushing	50	●	●	●	●	●	●	●	●	●	●	●	●			
	63	●	●	●	●	●	●	●	●	●	●	●	●			
	80	●	●	●	●	●	●	●	●	●	●	●	●			
	100	●	●	●	●	●	●	●	●	●	●	●	●			

Heavy duty guide rod type with improved load resistance

Stroke Variations

Bearing type	Bore size [mm]	Stroke [mm]							
		25	50	75	100	125	150	175	200
MGPS Slide bearing	50	●	●	●	●	●	●	●	●
	80	●	●	●	●	●	●	●	●

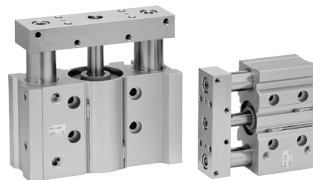

- Anti-lateral load : 10% increase
- Eccentric load resistance: 25% increase
- Impact load resistance : 140% increase
 (Compared with MGPM50 compact guide cylinder)

Bore size [mm]	Guide rod diameter [mm]	
	MGPS	MGPM
50	30	25
80	45	30





Proposals for Improving Product Life

SMC offers a wide range of models suitable for various applications and operating environments. This includes models that can be used in environments that the basic model cannot, such as those where coolant liquid, water droplets/splashing, dust, etc., are present. When using in environments where the above are present, it is possible to improve the service life of the product by selecting a model ideal for use in such environments.

- ➔ For details, refer to the **Web Catalog**.
- Environmental Resistance
- Measures Against Moisture/Drainage
- Measures Against Condensation
- Preventive and Predictive Maintenance
- High Rigidity

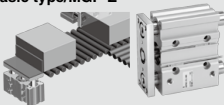
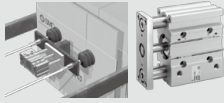
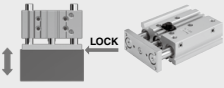
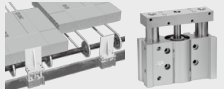

■ Compact Guide Cylinders, Series Variations

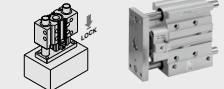
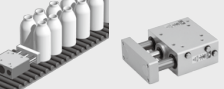
Series	Bearing type	Bore size										Page			
		6	10	12	16	20	25	32	40	50	63		80	100	
Basic type/MGP-Z 	Slide bearing			●	●	●	●	●	●	●	●	●	●		Page 536
	Ball bushing														
With air cushion/MGP-AZ 	High precision ball bushing			●	●	●	●	●	●	●	●	●	●		Page 558
With end lock/MGP-H/R 	Slide bearing														Page 575
	Ball bushing					●	●	●	●	●	●	●	●		
	High precision ball bushing														
Heavy duty guide rod/MGPS 	Slide bearing									●		●		Page 584	
Clean series/12/13-MGP-Z 	Ball bushing			●	●	●	●	●	●	●	●	●	●		Page 539
Water resistant cylinder/MGP R/V-Z 	Slide bearing														Page 540
Miniature Guide Rod Cylinder/MGJ 	Slide bearing	●	●												Page 519
Compact Guide Cylinder with Lock/MLGP 	Slide bearing														Web Catalog
	Ball bushing														
Hygienic Design Cylinder/HYG 	Slide bearing														Web Catalog

Combinations of Standard and Made to Order Specifications

MGP Series

●: Standard
⊙: Made to Order
○: Special product (Please contact SMC for details.)
—: Not available

Type	Basic type		
Bearing type	Slide bearing	Ball bushing	High precision ball bushing
Model	MGPM	MGPL	MGPA
Page	536		

Symbol	Specifications	Applicable bore size	ø12 to ø100		
Standard	Basic type		●	●	●
12-, 13-	Clean series	ø12 to ø63	—	●	—
25A-	Copper (Cu) and Zinc (Zn)-free *1	ø12 to ø100	●	●	○
20-	Copper and Fluorine-free *1		●	●*3	●*3
R/V	Water resistant (NBR seals/FKM *2)		●	—	—
MGP□M	Cylinder with stable lubrication function (Lube-retainer)		●	●	○
MGPM□G	Guide unit with Lube-retainer		●	—	—
MGP□F	With flange		●*5	●	●
-XA□	Change of guide rod end shape	ø12 to ø100	⊙	⊙	⊙
-XB6	Heat resistant cylinder (-10 to 150°C) *2		⊙	—	—
-XB10	Intermediate stroke (Using exclusive body)	ø12 to ø100	⊙	⊙	⊙
-XB13	Low speed cylinder (5 to 50 mm/s)		⊙	⊙	—
-XB22	Shock absorber soft type <i>RJ series type</i>		⊙	⊙	⊙
-XC4(W)	With heavy duty scraper	ø20 to ø100	⊙	⊙	⊙
-XC6	Made of stainless steel	ø12 to ø100	⊙	⊙	—
-XC8	Adjustable stroke cylinder/Adjustable extension type		⊙	⊙	⊙
-XC9	Adjustable stroke cylinder/Adjustable retraction type *2		⊙	⊙	⊙
-XC19	Intermediate stroke (Spacer type)	ø16 to ø100	—	—	—
-XC22	Fluororubber seal *2	ø12 to ø100	⊙	—	—
-XC35(W)	With coil scraper	ø20 to ø100	⊙	⊙	⊙
-XC69	With shock absorber	ø50 to ø100	⊙	⊙	⊙
-XC79	Tapped hole, drilled hole, pinned hole machined additionally	ø12 to ø100	⊙	⊙	⊙
-XC82	Bottom mounting type		⊙	—	—
-XC85	Grease for food processing equipment		⊙	⊙	⊙
-XC88(W)	Spatter resistant coil scraper, Lube-retainer, Grease for welding (Rod parts: Stainless steel 304)		⊙	—	—
-XC89W	Spatter resistant coil scraper, Lube-retainer, Grease for welding (Rod parts: S45C)	ø32 to ø100	⊙	—	—
-XC91(W)	Spatter resistant coil scraper, Grease for welding (Rod parts: S45C)		⊙	⊙	⊙
-XC92(W)	Dust resistant actuator *4	ø12 to ø100	⊙	—	—
-X144	Symmetrical port position	ø12 to ø100	⊙	⊙	⊙
-X471	Enlarged plate and body gap dimensions	ø12 to ø63	⊙	○	○
-X867	Side porting type (Plug location changed)	ø12 to ø100	⊙	⊙	⊙

*1: For details, refer to the **Web Catalog**.

*2: Without cushion

*3: Copper and fluorine-free are available as standard products.

*4: The shape is the same as the current product.

*5: This product cannot be used as a stopper.

	With air cushion			With end lock *4			Heavy duty guide *4 rod type	Symbol
	Slide bearing	Ball bushing	High precision ball bushing	Slide bearing	Ball bushing	High precision ball bushing	Slide bearing	
	MGPM	MGPL	MGPA	MGPM	MGPL	MGPA	MGPS	
	558			575			584	
	ø16 to ø100			ø20 to ø100			ø50, ø80	
●	●	●	●	●	●	●	●	Standard
—	○	—	—	—	○	—	—	12-, 13-
○	○	○	○	○	○	○	○	25A-
●	●*3	●*3	○	○	○	○	○	20-
○	—	—	○	—	—	—	○	R/V
○	○	○	○	○	○	○	○	MGP□M
○	—	—	—	—	—	—	○	MGPM□G
○	○	○	○	○	○	○	—	MGP□F
◎	◎	◎	○	○	○	○	○	-XA□
○	—	—	○	—	—	—	○	-XB6
○	○	○	○	○	○	○	○	-XB10
—	—	—	◎	◎	—	—	◎	-XB13
—	—	—	○	○	○	○	○	-XB22
○	○	○	○	○	○	○	○	-XC4(W)
○	○	—	○	○	—	—	○	-XC6
—	—	—	—	—	—	—	○	-XC8
—	—	—	—	—	—	—	○	-XC9
◎	◎	◎	—	—	—	—	—	-XC19
○	—	—	○	—	—	—	◎	-XC22
○	○	○	○	○	○	○	○	-XC35(W)
—	—	—	○	○	○	○	○	-XC69
◎	◎	◎	◎	◎	◎	◎	○	-XC79
○	—	—	○	—	—	—	○	-XC82
◎	◎	◎	◎	◎	◎	◎	◎	-XC85
○	—	—	○	—	—	—	○	-XC88(W)
○	—	—	○	—	—	—	○	-XC89W
○	○	○	○	○	○	○	○	-XC91(W)
○	—	—	○	—	—	—	○	-XC92(W)
○	○	○	○	○	○	○	○	-X144
○	○	○	○	○	○	○	○	-X471
◎	◎	◎	◎	◎	◎	◎	◎	-X867

CONTENTS

Compact Guide Cylinder *MGP Series*

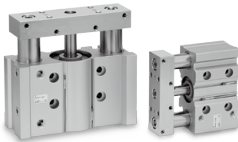
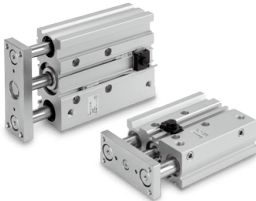

● Compact Guide Cylinder/Basic Type *MGP-Z Series*

How to Order	Page 536
Specifications	Page 537
Clean Series	Page 539
Water Resistant Cylinder	Page 540
Cylinder with Stable Lubrication Function (Lube-retainer)	Page 541
Guide Unit with Lube-retainer	Page 541
Model Selection	Page 545
Construction	Page 553
Dimensions	Page 555

● Compact Guide Cylinder/With Air Cushion *MGP-AZ Series*

How to Order	Page 558
Specifications	Page 559
Model Selection	Page 562
Construction	Page 570
Dimensions	Page 572

● Compact Guide Cylinder/With End Lock *MGP Series*

How to Order	Page 575
Specifications	Page 576
Construction	Page 578
Dimensions	Page 580
Specific Product Precautions	Page 583

● Compact Guide Cylinder/Heavy Duty Guide Rod Type *MGPS Series*

How to Order	Page 584
Specifications	Page 585
Model Selection	Page 586
Construction	Page 590
Dimensions	Page 591

● Auto Switch Mounting	Page 592
● Specific Product Precautions	Page 599

Compact Guide Cylinder

MGP Series

ø12, ø16, ø20, ø25, ø32, ø40, ø50, ø63, ø80, ø100

How to Order

MGP **M** **25** - **30** **Z** - **M9BW** -

Compact Guide Cylinder

Made to Order
For details, refer to page 537.

Bearing type

M	Slide bearing
L	Ball bushing
A	High precision ball bushing

Bore size

12	12 mm	40	40 mm
16	16 mm	50	50 mm
20	20 mm	63	63 mm
25	25 mm	80	80 mm
32	32 mm	100	100 mm

Port thread type

Nil	M5 x 0.8
TN	NPT
TF	G

*: For bore sizes ø12 and ø16, only M5 x 0.8 is available.

Number of auto switches

Nil	2 pcs.
S	1 pc.
n	n pcs.

Auto switch

Nil	Without auto switch (Built-in magnet)
------------	---------------------------------------

*: For applicable auto switches, refer to the table below.

Cylinder stroke [mm]

Refer to Standard Strokes on page 537.

Proposals for Improving Water and Dust-resistance

SMC offers a wide range of models suitable for various operating environments. This includes models that can be used in environments that the basic model cannot, such as those where coolant liquid, water droplets/splashing, dust, etc., are present. See below for details.

- Water resistant cylinder (➔ Refer to page 540.)
- Cylinder with stable lubrication function (Lube-retainer) (➔ Refer to page 541.)
- Dust resistant cylinder (➔ Web Catalog)

Applicable Auto Switches/Refer to pages 1289 to 1383 for further information on auto switches.

Type	Special function	Electrical entry	Indicator light	Wiring (Output)	Load voltage		Auto switch model		Lead wire length [m]				Pre-wired connector	Applicable load		
					DC	AC	Perpendicular	In-line	0.5 (Nil)	1 (M)	3 (L)	5 (Z)				
Solid state auto switch	—	Grommet	Yes	3-wire (NPN)	5 V, 12 V	—	M9NV	M9N	●	●	○	○	○	IC circuit	Relay, PLC	
				3-wire (PNP)			M9PV	M9P	●	●	○	○	○			
				2-wire	12 V		M9BV	M9B	●	●	○	○	○	—		
				3-wire (NPN)	5 V, 12 V		M9NWV	M9NW	●	●	○	○	○	IC circuit		
	3-wire (PNP)			M9P WV			M9PW	●	●	○	○	○	IC circuit			
	Diagnostic indication (2-color indicator)			2-wire	24 V		12 V	M9B WV	M9B W	●	●	○	○	○		—
								3-wire (NPN)	M9NAV *1	M9NA *1	○	○	○	○		○
				3-wire (PNP)	M9PAV *1		M9PA *1	○	○	○	○	○	IC circuit			
2-wire		12 V	M9BA *1	M9BA *1	○	○	○	○	○	—						
Magnetic field resistant (2-color indicator)	2-wire (Non-polar)	—	—	—	P3DWA *2	●	—	●	●	○	—					
	—	—	—	—	—	—	—	—	—	○	—					
Reed auto switch	—	Grommet	Yes	3-wire (NPN equivalent)	—	5 V	—	A96V	A96	●	—	●	—	—	IC circuit	—
				2-wire	24 V	12 V	100 V	A93V *3	A93	●	●	●	●	—	—	Relay, PLC
—	—	No	—	2-wire	24 V	12 V	100 V or less	A90V	A90	●	—	●	—	—	IC circuit	—

*1: Water resistant type auto switches are mountable on the above models, but in such case SMC cannot guarantee water resistance.

A water resistant type cylinder is recommended for use in an environment which requires water resistance.

However, please contact SMC for water resistant products of ø12 and ø16.

*2: The D-P3DWA□ is mountable on bore size ø25 to ø100.

*3: 1 m type lead wire is only applicable to the D-A93.

*: Lead wire length symbols: 0.5 m-----Nil (Example) M9NW
1 m-----M (Example) M9NWM
3 m-----L (Example) M9NWL
5 m-----Z (Example) M9NWX

*: Solid state auto switches marked with "○" are produced upon receipt of order.

*: Other than the auto switches listed above, the D-P4DW type can be mounted. Refer to page 595 for details.

*: For details about auto switches with pre-wired connector, refer to pages 1358 and 1359.

*: Auto switches are shipped together, (but not assembled).

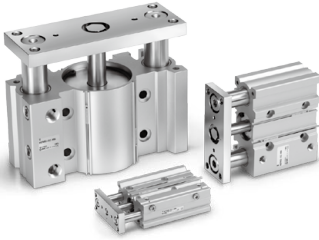

Symbol
Rubber bumper

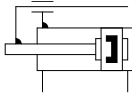

Made to Order: Individual Specifications
(For details, refer to pages 597 and 598.)

Symbol	Specifications
-X144	Symmetrical port position
-X471	Enlarged plate and body gap dimensions
-X867	Side porting type (Plug location changed)



Made to Order
[Click here for details](#)

Symbol	Specifications
-XA□	Change of guide rod end shape
-XB6	Heat resistant cylinder (-10 to 150°C)
-XB10	Intermediate stroke (Using exclusive body)
-XB13	Low speed cylinder (5 to 50 mm/s)
-XB22	Shock absorber soft type RJ series type
-XC4	With heavy duty scraper
-XC6	Made of stainless steel
-XC8	Adjustable stroke cylinder/Adjustable extension type
-XC9	Adjustable stroke cylinder/Adjustable retraction type
-XC22	Fluororubber seal
-XC35	With coil scraper
-XC69	With shock absorber
-XC79	Tapped hole, drilled hole, pinned hole machined additionally
-XC82	Bottom mounting type
-XC85	Grease for food processing equipment
-XC88(W)	Spatter resistant coil scraper, Lube-retainer, Grease for welding (Rod parts: Stainless steel 304)
-XC89W	Spatter resistant coil scraper, Lube-retainer, Grease for welding (Rod parts: S45C)
-XC91(W)	Spatter resistant coil scraper, Grease for welding (Rod parts: S45C)
-XC92	Dust resistant actuator *1

*1: The shape is the same as the current product.

Refer to pages 592 to 596 for cylinders with auto switches.
<ul style="list-style-type: none"> Auto switch proper mounting position (detection at stroke end) and its mounting height Minimum stroke for auto switch mounting Operating range Auto switch mounting brackets/Part no. Auto Switch Mounting

Specifications

Bore size [mm]	12	16	20	25	32	40	50	63	80	100
Action	Double acting									
Fluid	Air									
Proof pressure	1.5 MPa									
Maximum operating pressure	1.0 MPa									
Minimum operating pressure	0.12 MPa					0.1 MPa				
Ambient and fluid temperature	-10 to 60°C (No freezing)									
Piston speed *1	50 to 500 mm/s								50 to 400 mm/s	
Cushion	Rubber bumper on both ends									
Lubrication	Not required (Non-lube)									
Stroke length tolerance	$^{+15}_{-0.5}$ mm									

*1: Maximum speed with no load. Depending on the operating conditions, the piston speed may not be satisfied.
Make a model selection, considering a load according to the graph on pages 545 to 551.

Standard Strokes

Bore size [mm]	Standard stroke [mm]									
12, 16	10, 20, 30, 40, 50, 75, 100, 125, 150, 175, 200, 250									
20, 25	20, 30, 40, 50, 75, 100, 125, 150, 175, 200, 250, 300, 350, 400									
32 to 100	25, 50, 75, 100, 125, 150, 175, 200, 250, 300, 350, 400									

Manufacture of Intermediate Strokes

Description	Spacer installation type Spacers are installed in the standard stroke cylinder. • ø12 to ø32. Available in 1 mm stroke increments. • ø40 to ø100. Available in 5 mm stroke increments.	Exclusive body (-XB10) Dealing with the stroke by making an exclusive body. • All bore sizes are available in 1 mm increments.												
Model no.	Refer to How to Order for the standard model numbers.	Add "XB10" to the end of standard model number. For details, refer to Made to Order.												
Applicable stroke [mm]	<table border="1"> <tr> <td>ø12, ø16</td> <td>1 to 249</td> </tr> <tr> <td>ø20, ø25, ø32</td> <td>1 to 399</td> </tr> <tr> <td>ø40 to ø100</td> <td>5 to 395</td> </tr> </table>	ø12, ø16	1 to 249	ø20, ø25, ø32	1 to 399	ø40 to ø100	5 to 395	<table border="1"> <tr> <td>ø12, ø16</td> <td>11 to 249</td> </tr> <tr> <td>ø20, ø25</td> <td>21 to 399</td> </tr> <tr> <td>ø32 to ø100</td> <td>26 to 399</td> </tr> </table>	ø12, ø16	11 to 249	ø20, ø25	21 to 399	ø32 to ø100	26 to 399
ø12, ø16	1 to 249													
ø20, ø25, ø32	1 to 399													
ø40 to ø100	5 to 395													
ø12, ø16	11 to 249													
ø20, ø25	21 to 399													
ø32 to ø100	26 to 399													
Example	Part no.: MGP20-39Z A spacer 1 mm in width is installed in the MGP20-40. C dimension is 77 mm.	Part no.: MGP20-39Z-XB10 Special body manufactured for 39 stroke. C dimension is 76 mm.												

Theoretical Output

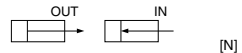

Bore size [mm]	Rod size [mm]	Operating direction	Piston area [mm ²]	Operating pressure [MPa]									
				0.2	0.3	0.4	0.5	0.6	0.7	0.8	0.9	1.0	
12	6	OUT	113	23	34	45	57	68	79	90	102	113	
		IN	85	17	25	34	42	51	59	68	76	85	
16	8	OUT	201	40	60	80	101	121	141	161	181	201	
		IN	151	30	45	60	75	90	106	121	136	151	
20	10	OUT	314	63	94	126	157	188	220	251	283	314	
		IN	236	47	71	94	118	141	165	188	212	236	
25	10	OUT	491	98	147	196	245	295	344	393	442	491	
		IN	412	82	124	165	206	247	289	330	371	412	
32	14	OUT	804	161	241	322	402	483	563	643	724	804	
		IN	650	130	195	260	325	390	455	520	585	650	
40	14	OUT	1257	251	377	503	628	754	880	1005	1131	1257	
		IN	1103	221	331	441	551	662	772	882	992	1103	
50	18	OUT	1963	393	589	785	982	1178	1374	1571	1767	1963	
		IN	1709	342	513	684	855	1025	1196	1367	1538	1709	
63	18	OUT	3117	623	935	1247	1559	1870	2182	2494	2806	3117	
		IN	2863	573	859	1145	1431	1718	2004	2290	2576	2863	
80	22	OUT	5027	1005	1508	2011	2513	3016	3519	4021	4524	5027	
		IN	4646	929	1394	1859	2323	2788	3252	3717	4182	4646	
100	26	OUT	7854	1571	2356	3142	3927	4712	5498	6283	7069	7854	
		IN	7323	1465	2197	2929	3662	4394	5126	5858	6591	7323	

*: Theoretical output [N] = Pressure [MPa] × Piston area [mm²]

Weights

Slide Bearing: MGPM12 to 100

Bore size [mm]	Standard stroke [mm]																[kg]
	10	20	25	30	40	50	75	100	125	150	175	200	250	300	350	400	
12	0.22	0.25	—	0.29	0.33	0.36	0.46	0.55	0.66	0.75	0.84	0.93	1.11	—	—	—	
16	0.32	0.37	—	0.42	0.46	0.51	0.66	0.78	0.94	1.06	1.18	1.31	1.55	—	—	—	
20	—	0.59	—	0.67	0.74	0.82	1.06	1.24	1.43	1.61	1.80	1.99	2.42	2.79	3.16	3.53	
25	—	0.84	—	0.94	1.04	1.14	1.50	1.75	2.00	2.25	2.50	2.75	3.35	3.85	4.34	4.84	
32	—	—	1.41	—	—	1.77	2.22	2.57	2.93	3.29	3.65	4.00	4.90	5.61	6.33	7.04	
40	—	—	1.64	—	—	2.04	2.52	2.92	3.32	3.71	4.11	4.50	5.47	6.26	7.06	7.85	
50	—	—	2.79	—	—	3.38	4.13	4.71	5.30	5.89	6.47	7.06	8.55	9.73	10.9	12.1	
63	—	—	3.48	—	—	4.15	4.99	5.67	6.34	7.02	7.69	8.37	10.0	11.4	12.7	14.1	
80	—	—	5.41	—	—	6.26	7.41	8.26	9.10	9.95	10.8	11.6	13.9	15.6	17.3	19.0	
100	—	—	9.12	—	—	10.3	12.0	13.2	14.4	15.6	16.9	18.1	21.2	23.6	26.1	28.5	

Ball Bushing: MGPL12 to 100, High Precision Ball Bushing: MGPA12 to 100

Bore size [mm]	Standard stroke [mm]																[kg]
	10	20	25	30	40	50	75	100	125	150	175	200	250	300	350	400	
12	0.21	0.24	—	0.27	0.32	0.35	0.43	0.50	0.59	0.67	0.75	0.83	0.99	—	—	—	
16	0.31	0.35	—	0.40	0.47	0.51	0.62	0.72	0.85	0.96	1.06	1.17	1.38	—	—	—	
20	—	0.60	—	0.66	0.79	0.85	1.01	1.17	1.36	1.52	1.68	1.84	2.17	2.49	2.81	3.13	
25	—	0.87	—	0.96	1.12	1.20	1.41	1.62	1.86	2.06	2.27	2.48	2.92	3.33	3.75	4.16	
32	—	—	1.37	—	—	1.66	2.08	2.37	2.74	3.03	3.31	3.60	4.25	4.82	5.39	5.97	
40	—	—	1.59	—	—	1.92	2.38	2.70	3.11	3.44	3.77	4.09	4.81	5.46	6.11	6.76	
50	—	—	2.65	—	—	3.14	3.85	4.34	4.97	5.47	5.96	6.45	7.57	8.56	9.54	10.5	
63	—	—	3.33	—	—	3.91	4.71	5.29	6.01	6.59	7.17	7.75	9.05	10.2	11.4	12.5	
80	—	—	5.27	—	—	6.29	7.49	8.21	8.92	9.64	10.4	11.1	12.9	14.3	15.7	17.2	
100	—	—	8.62	—	—	10.1	11.8	12.9	13.9	15.0	16.0	17.1	19.6	21.7	23.8	25.9	



① Clean Series

Applicable in a clean room environment. Ideal for use in conveyor lines for semiconductor (LSI), liquid crystal (LCD), food processing, pharmaceutical, and electronic parts, etc.

How to Order

12 — MGPL Bore size — Stroke Z

Clean room specifications

12	Relief port type
13	Vacuum port type

Thread type

Nil	M5 x 0.8
	Rc
TN	NPT
TF	G

*: For bore sizes 12 and 16, M5 x 0.8 is only available.

Specifications

Applicable series	MGPL							
Bearing type	Ball bushing bearing							
Bore size [mm]	12	16	20	25	32	40	50	63
Stroke [mm]	10 to 250		20 to 400		25 to 400			

*: Specifications other than above are the same as standard, basic type.

Dimensions

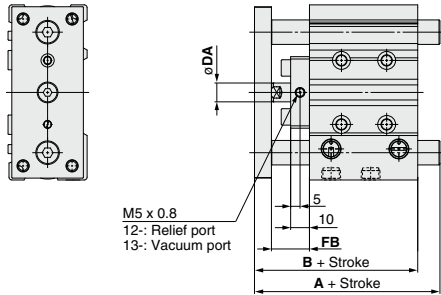

M5 x 0.8
12-: Relief port
13-: Vacuum port

*: For details, refer to the **Web Catalog**.

*: Other dimensions are the same as standard products. *: The dimensions in () are the same as standard type. [mm]

Bore size [mm]	A				B	DA	FB
	30 st or less	Over 30 st and up to 100 st	Over 100 st and up to 200 st	Over 200 st			
12	56	68	97.5	97.5	55	(6)	19
16	62	78	107.5	107.5	59	(8)	19
20	72	89	113	130.5	66	(10)	21
25	78.5	94.5	113.5	130.5	66.5	(10)	20

*: For bore size $\phi 12$ and $\phi 16$, only M5 x 0.8 port is available.

*: For bore size $\phi 20$ or more, choice of Rc, NPT, G port is available. (Refer to page 536.)

Bore size [mm]	A				B	DA	FB
	50 st or less	Over 50 st and up to 100 st	Over 100 st and up to 200 st	Over 200 st			
32	91.5	108.5	128.5	150.5	71.5	(14)	24
40	91.5	108.5	128.5	150.5	78	(14)	24
50	102.5	123.5	143.5	170.5	83	20	27
63	102.5	123.5	143.5	170.5	88	20	27

*: Choice of Rc, NPT, G port is available. (Refer to page 536.)

MGP Series

② Water Resistant Cylinder

Ideal for use in a machine tool environment exposed to coolants. Applicable for use in an environment with water splashing such as food processing and car wash equipment, etc.



How to Order

MGPM Bore size **R** Stroke **Z** - **M9** **A(V)L** - **XC6A**

Thread type

NI	Rc
TN	NPT
TF	G

Water Resistant Cylinder

R	NBR seals (Nitrile rubber)
V	FKM seals (Fluororubber)

Water resistant
2-color indicator
solid state auto
switch

Made to Order

- *: Piston rod and guide rod are made of stainless steel.
- *: Please contact SMC when using liquids that contain sulfur.

Specifications

Applicable series	MGPM
Bearing type	Slide bearing
Bore size [mm]	20, 25, 32, 40, 50, 63, 80, 100
Cushion	MGPM□□R Rubber bumper MGPM□□V Without cushion
Minimum operating pressure	0.13 MPa
Made to Order	XC6A Specified parts made of stainless steel

- *: Bore sizes 12 and 16 mm are only available as a special order. Contact SMC for further details.
- *: Specifications other than above are the same as standard, basic type.
- *: For details on the made-to-order XC6A with specified parts made of stainless steel, refer to page 1488.

Dimensions

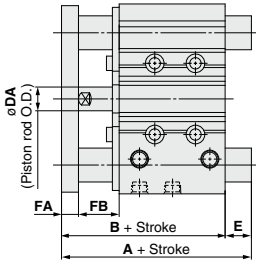

Water resistant [mm]

Bore size [mm]	A			B	DA	FA	FB
	50 st or less	Over 50 st and up to 200 st	Over 200 st				
20	66	90.5	123	66	(10)	(8)	21
25	67.5	91.5	123.5	67.5	(10)	(9)	21
32	87	105.5	141.5	71.5	(14)	(10)	24
40	87	105.5	141.5	78	(14)	(10)	24
50	99.5	120.5	161.5	83	20	(12)	27
63	99.5	120.5	161.5	88	20	(12)	27
80	110.5	137.5	186.5	102.5	25	(16)	30
100	130.5	155.5	194.5	120	30	(19)	35

Water resistant + XC6A [mm]

Bore size [mm]	A			B	DA	FA	FB
	50 st or less	Over 50 st and up to 200 st	Over 200 st				
20	66	90.5	123	66	(10)	9	20
25	67.5	91.5	123.5	67.5	(10)	10	20
32	87	105.5	141.5	71.5	(14)	12	22
40	87	105.5	141.5	78	(14)	12	22
50	99.5	120.5	161.5	83	20	16	23
63	99.5	120.5	161.5	88	20	16	23
80	110.5	137.5	186.5	102.5	25	19	27
100	130.5	155.5	194.5	120	30	22	32

- *: Other dimensions are the same as standard products.
- *: The dimensions in () are the same as standard type.

Click [here](#) for details.

③ Cylinder with Stable Lubrication Function (Lube-retainer)

Improves durability in environments with micro-powder. (Compared with the standard model)
In addition, the overall length and mounting are the same as those of the standard model.



How to Order

MGP **Bearing type** **Bore size** **Port thread type** **M** - **Stroke** **Z** - **Auto switch**

• Cylinder with stable lubrication function (Lube-retainer)

Specifications

Bore size [mm]	20, 25, 32, 40, 50, 63, 80, 100
Minimum operating pressure	0.15 MPa

- *: Bore sizes 12 and 16 mm are only available as a special order. Contact SMC for further details.
- *: Specifications other than above are the same as standard, basic type.

Dimensions (Dimensions are the same as the standard type.)

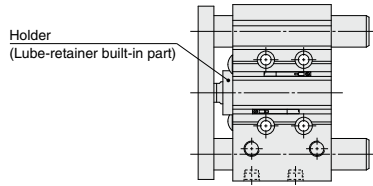

Click [here](#) for details.

④ Guide Unit with Lube-retainer

How to Order

MGP **M** **Bore size** **Port thread type** **G** - **Stroke** **Z** - **Auto switch**

• Slide bearing

• Guide unit with Lube-retainer



Specifications

Bore size [mm]	20, 25, 32, 40, 50, 63, 80, 100
Bearing type	Slide bearing

- *: Bore sizes 12 and 16 mm are only available as a special order. Contact SMC for further details.
- *: Specifications other than above are the same as standard, basic type.

Dimensions (Dimensions other than below are the same as standard type.)

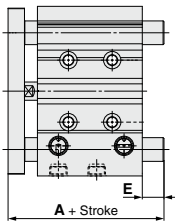

Bore size [mm]	[mm]					
	A			E		
	50 st or less	Over 50 st to 200 st	Over 200 st	50 st or less	Over 50 st to 200 st	Over 200 st
20	(53)	83	115.5	(0)	30	62.5
25	(53.5)	83.5	115.5	(0)	30	62
32	82	100.5	136.5	22.5	41	77
40	82	100.5	136.5	16	34.5	70.5
50	95.5	116.5	157.5	23.5	44.5	85.5
63	95.5	116.5	157.5	18.5	39.5	80.5
80	113.5	140.5	189.5	17	44	93
100	135.5	160.5	199.5	19.5	44.5	83.5

The dimensions in () are the same as standard type.

MGP Series

⑤ With Flange

Plate side flange type is added.

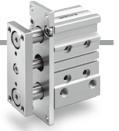

How to Order

MGP Bearing type **F** Bore size Port thread type – Stroke Z – Auto switch

↓ With flange

⚠ Caution

This product cannot be used as a stopper.

Specifications: Same as standard type

Dimensions (Dimensions other than below are the same as standard type.)

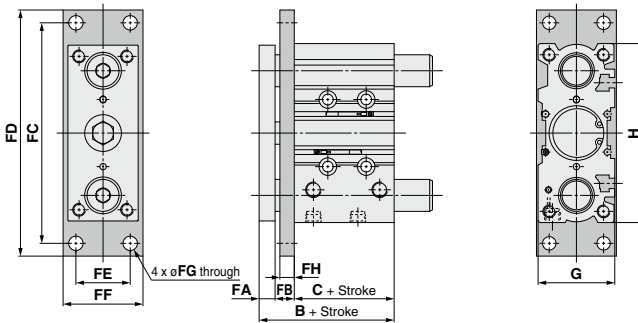

Bore size	B	C	FA	FB	FC	FD	FE	FF	FG	FH	G	H	Flange weight (kg)
12	42	29	7	6	80	89	18	25	4.5	5	26	58	0.08
16	46	33	7	6	88	98	22	32	5.5	5	30	64	0.11
20	53	37	8	8	102	112	24	38	5.5	6	36	83	0.17
25	53.5	37.5	9	7	114	126	30	40	6.6	6	42	93	0.20
32	59.5	37.5	10	12	138	154	34	50	9	9	48	112	0.46
40	66	44	10	12	146	162	40	60	9	9	54	120	0.60
50	72	44	12	16	178	198	46	65	11	10	64	148	0.87
63	77	49	12	16	192	212	58	75	11	10	78	162	1.09
80	96.5	56.5	16	24	238	262	54	90	13.5	16	91.5	202	2.59
100	116	66	19	31	280	308	62	100	15.5	22	111.5	240	4.63

Allowable Rotational Torque of Plate

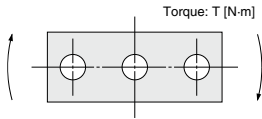

Bore size [mm]	Bearing type	Stroke [mm]															
		10	20	25	30	40	50	75	100	125	150	175	200	250	300	350	400
12	MGPM	0.39	0.32	—	0.27	0.24	0.21	0.43	0.36	0.31	0.27	0.24	0.22	0.19	—	—	—
	MGPL/A	0.61	0.45	—	0.35	0.58	0.50	0.37	0.29	0.24	0.20	0.18	0.16	0.12	—	—	—
16	MGPM	0.69	0.58	—	0.49	0.43	0.38	0.69	0.58	0.50	0.44	0.40	0.36	0.30	—	—	—
	MGPL/A	0.99	0.74	—	0.59	0.99	0.86	0.65	0.52	0.43	0.37	0.32	0.28	0.23	—	—	—
20	MGPM	—	1.05	—	0.93	0.83	0.75	1.88	1.63	1.44	1.28	1.16	1.06	0.90	0.78	0.69	0.62
	MGPL/A	—	1.26	—	1.03	2.17	1.94	1.52	1.25	1.34	1.17	1.03	0.93	0.76	0.65	0.56	0.49
25	MGPM	—	1.76	—	1.55	1.38	1.25	2.96	2.57	2.26	2.02	1.83	1.67	1.42	1.24	1.09	0.98
	MGPL/A	—	2.11	—	1.75	3.37	3.02	2.38	1.97	2.05	2.02	1.78	1.58	1.41	1.16	0.98	0.85
32	MGPM	—	—	6.35	—	—	5.13	5.69	4.97	4.42	3.98	3.61	3.31	2.84	2.48	2.20	1.98
	MGPL/A	—	—	5.95	—	—	4.89	5.11	4.51	6.34	5.79	5.33	4.93	4.29	3.78	3.38	3.04
40	MGPM	—	—	7.00	—	—	5.66	6.27	5.48	4.87	4.38	3.98	3.65	3.13	2.74	2.43	2.19
	MGPL/A	—	—	6.55	—	—	5.39	5.62	4.96	6.98	6.38	5.87	5.43	4.72	4.16	3.71	3.35
50	MGPM	—	—	13.0	—	—	10.8	12.0	10.6	9.50	8.60	7.86	7.24	6.24	5.49	4.90	4.43
	MGPL/A	—	—	9.17	—	—	7.62	9.83	8.74	11.6	10.7	9.83	9.12	7.95	7.02	6.26	5.63
63	MGPM	—	—	14.7	—	—	12.1	13.5	11.9	10.7	9.69	8.86	8.16	7.04	6.19	5.52	4.99
	MGPL/A	—	—	10.2	—	—	8.48	11.0	9.74	13.0	11.9	11.0	10.2	8.84	7.80	6.94	6.24
80	MGPM	—	—	21.9	—	—	18.6	22.9	20.5	18.6	17.0	15.6	14.5	12.6	11.2	10.0	9.11
	MGPL/A	—	—	15.1	—	—	23.3	22.7	20.6	18.9	17.3	16.0	14.8	12.9	11.3	10.0	8.94
100	MGPM	—	—	38.8	—	—	33.5	37.5	33.8	30.9	28.4	26.2	24.4	21.4	19.1	17.2	15.7
	MGPL/A	—	—	27.1	—	—	30.6	37.9	34.6	31.8	29.3	27.2	25.3	22.1	19.5	17.3	15.5

Non-rotating Accuracy of Plate

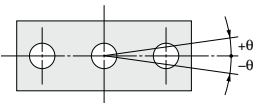

Non-rotating accuracy θ when retracted and when no load is applied should be not more than the values shown in the table.

Bore size [mm]	Non-rotating accuracy θ		
	MGPM	MGPL	MGPA
12	$\pm 0.07^\circ$	$\pm 0.05^\circ$	$\pm 0.01^\circ$
16			
20	$\pm 0.06^\circ$	$\pm 0.04^\circ$	
25			
32	$\pm 0.05^\circ$	$\pm 0.03^\circ$	
40			
50	$\pm 0.04^\circ$	$\pm 0.03^\circ$	
63			
80	$\pm 0.03^\circ$	$\pm 0.03^\circ$	
100			

High Precision Ball Bushing/MGPA

⚠ Caution

Positioning accuracy for pin hole on the plate

Dispersion of dimensions when machining each component will be accumulated in the plate pin hole positioning accuracy when mounting this cylinder. Values below are referred as a guide.

[Side mounting]

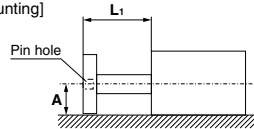

$$A = \text{Catalog dimension} \pm^* (0.1 + L_1 \times 0.0008) \text{ [mm]}$$

*: To be 0.15 for $\phi 80, \phi 100$

Note) Displacement by load and self-weight deflection by plate and guide rod are not included.

[Bottom mounting]

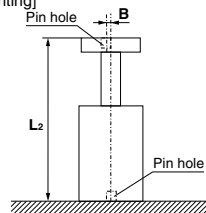

$$B = \pm (0.045 + L_2 \times 0.0016) \text{ [mm]}$$

High Precision Ball Bushing/MGPA Plate Displacement Amount (Reference Values)

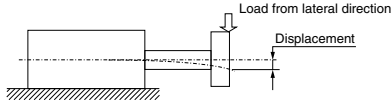

MGPA12

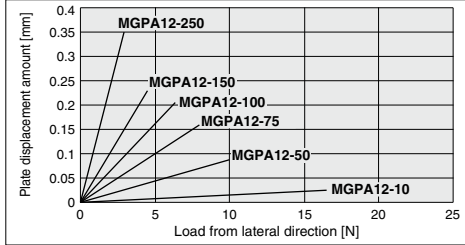

MGPA32, 40

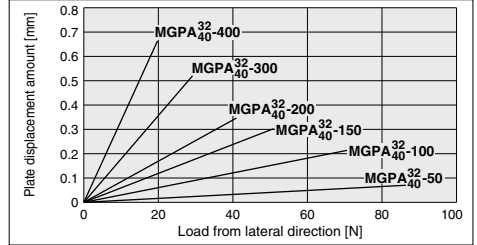

MGPA16

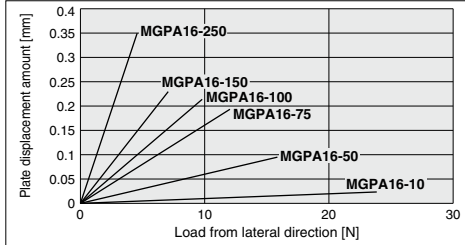

MGPA50, 63

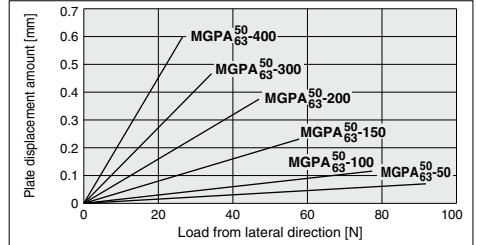

MGPA20

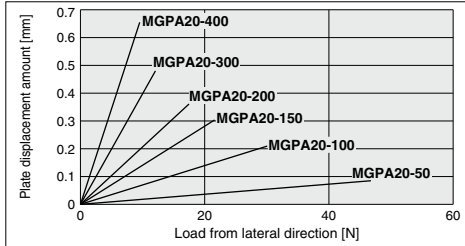

MGPA80

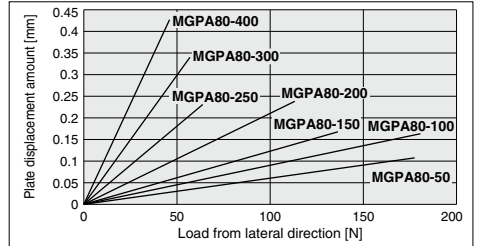

MGPA25

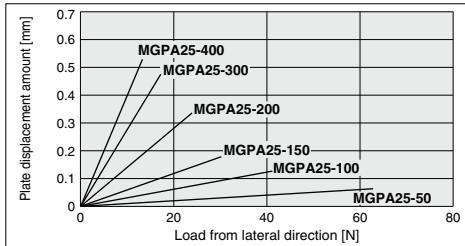

MGPA100

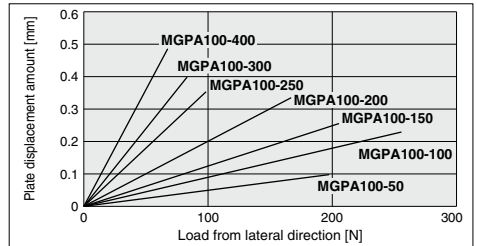

*: The guide rod and self-weight for the plate are not included in the above displacement values.
 *: Allowable rotating torque, and operating range when used as a lifter, are the same as those of the MGPL series.

Basic Type MGP Series Model Selection

Selection Conditions

Mounting orientation	Vertical		Horizontal	
Maximum speed [mm/s]	200 or less	400	200 or less	400
Graph (Slide bearing)	(1), (2)	(3), (4)	(13), (14)	(15), (16)
Graph (Ball bushing)	(5) to (8)	(9) to (12)	(17), (18)	(19), (20)

Selection Example 1 (Vertical Mounting)

Selection conditions

Mounting: Vertical
Bearing type: Ball bushing
Stroke: 30 stroke
Maximum speed: 200 mm/s
Load mass: 3 kg
Eccentric distance: 90 mm

Find the point of intersection for the load mass of 3 kg and the eccentric distance of 90 mm on graph (5), based on vertical mounting, ball bushing, 30 stroke, and the speed of 200 mm/s.

→ **MGPL25-30Z** is selected.

Selection Example 2 (Horizontal Mounting)

Selection conditions

Mounting: Horizontal
Bearing type: Slide bearing
Distance between plate and load center of gravity: 50 mm
Maximum speed: 200 mm/s
Load mass: 2 kg
Stroke: 30 stroke

Find the point of intersection for the load mass of 2 kg and 30 stroke on graph (13), based on horizontal mounting, slide bearing, the distance of 50 mm between the plate and load center of gravity, and the speed of 200 mm/s.

→ **MGPM20-30Z** is selected.

(5) 30 stroke or less, $V = 200$ mm/s or less

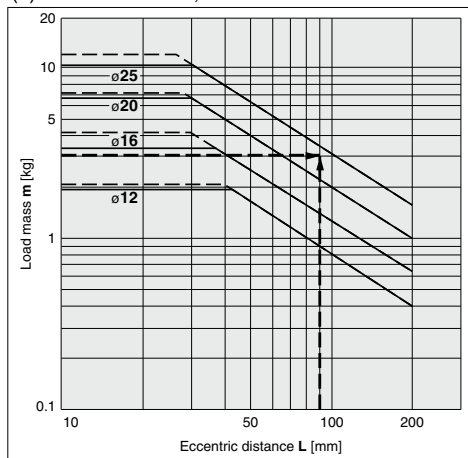

(13) $L = 50$ mm, $V = 200$ mm/s or less

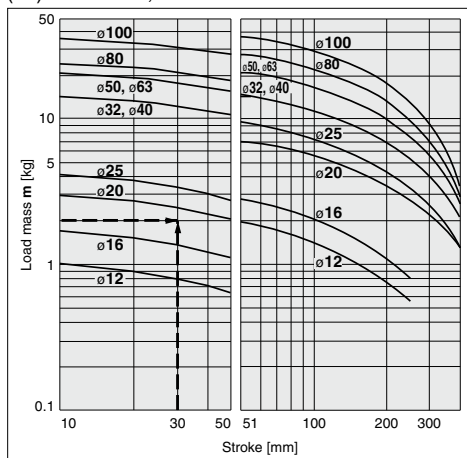

· When the maximum speed exceeds 200 mm/s, the allowable load mass is determined by multiplying the value shown in the graph at 400 mm/s by the coefficient listed in the table below.

Max. speed	Up to 300 mm/s	Up to 400 mm/s	Up to 500 mm/s
Coefficient	1.7	1	0.6

· Use the Guide Cylinder Selection Software, when the eccentric distance is 200 mm or more.

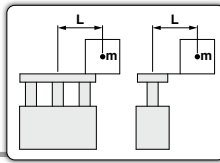

Vertical Mounting **Slide Bearing**

— Operating pressure 0.4 MPa
 - - - - - Operating pressure 0.5 MPa or more

MGPM12 to 100

(1) 50 stroke or less, $V = 200$ mm/s or less

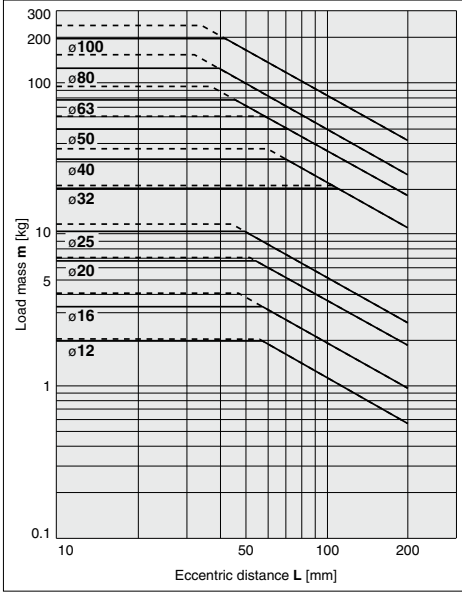

(2) Over 50 stroke, $V = 200$ mm/s or less

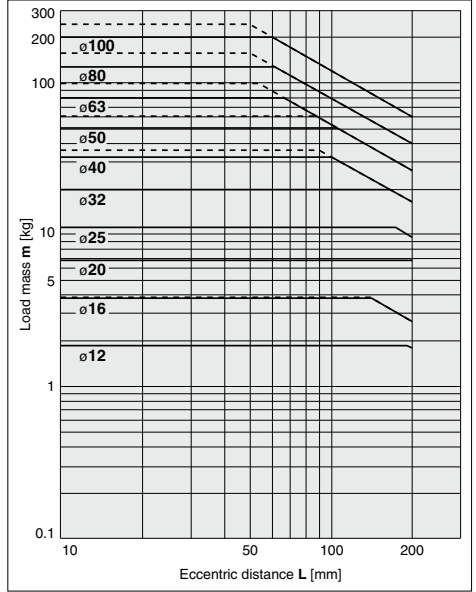

(3) 50 stroke or less, $V = 400$ mm/s

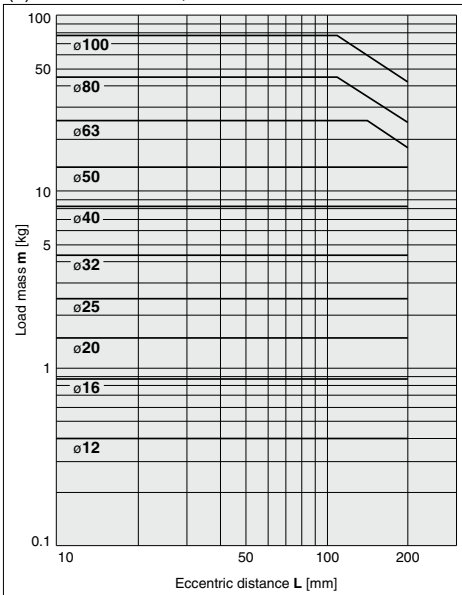

(4) Over 50 stroke, $V = 400$ mm/s

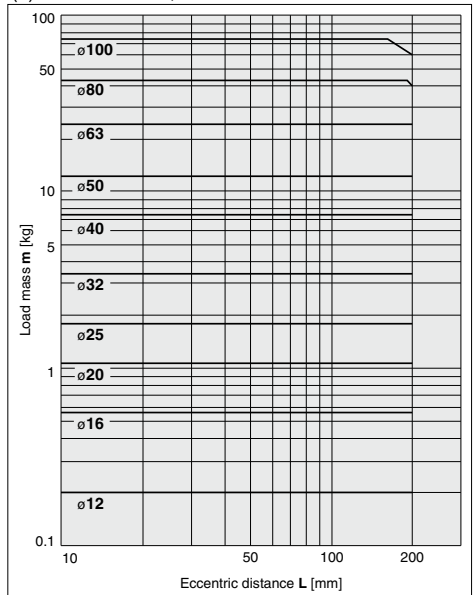

· Use the Guide Cylinder Selection Software, when the eccentric distance is 200 mm or more.

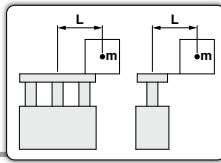

— Operating pressure 0.4 MPa
 - - - - - Operating pressure 0.5 MPa or more

Vertical Mounting **Ball Bushing**

MGPL12 to 25, MGPA12 to 25

(5) 30 stroke or less, $V = 200$ mm/s or less

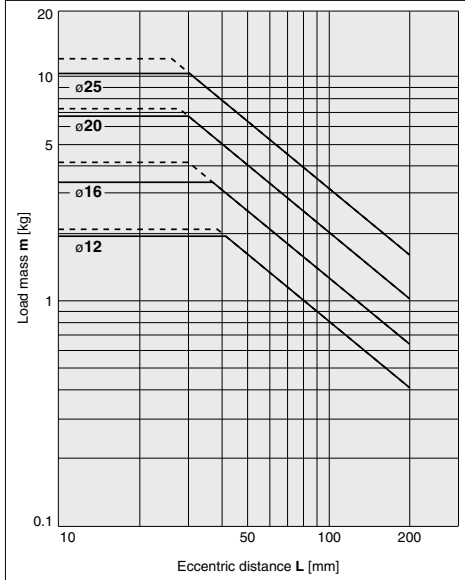

(6) Over 30 stroke, $V = 200$ mm/s or less

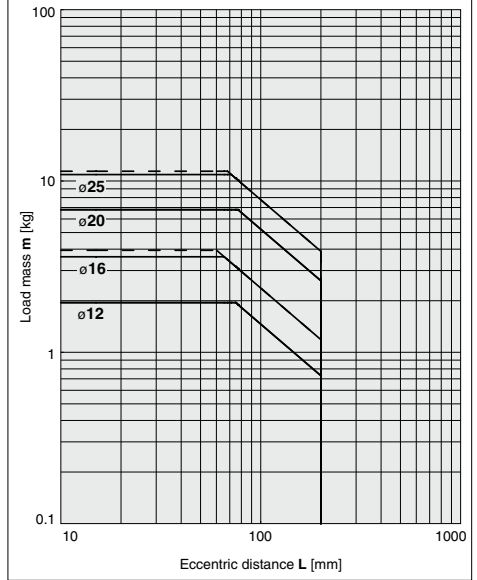

MGPL32 to 100, MGPA32 to 100

(7) 50 stroke or less, $V = 200$ mm/s or less

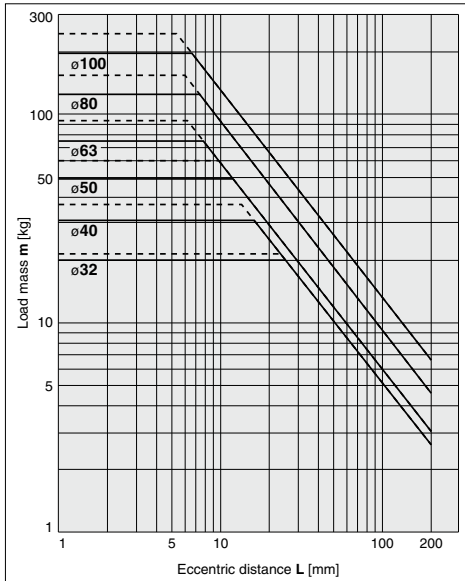

(8) Over 50 stroke, $V = 200$ mm/s or less

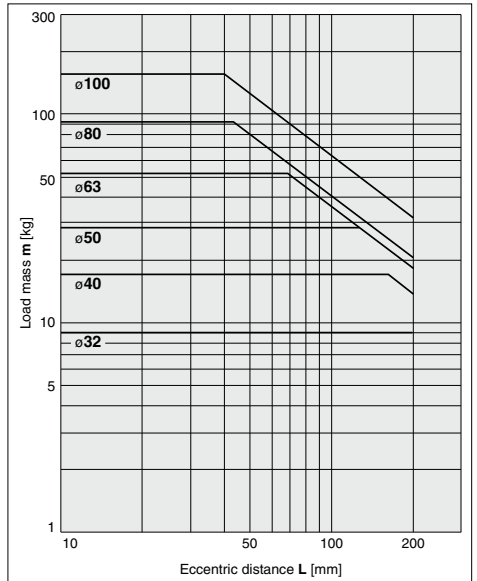

· Use the Guide Cylinder Selection Software, when the eccentric distance is 200 mm or more.

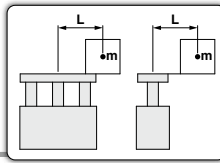

Vertical Mounting **Ball Bushing**

— Operating pressure 0.4 MPa

MGPL12 to 25, MGPA12 to 25

(9) 30 stroke or less, $V = 400$ mm/s

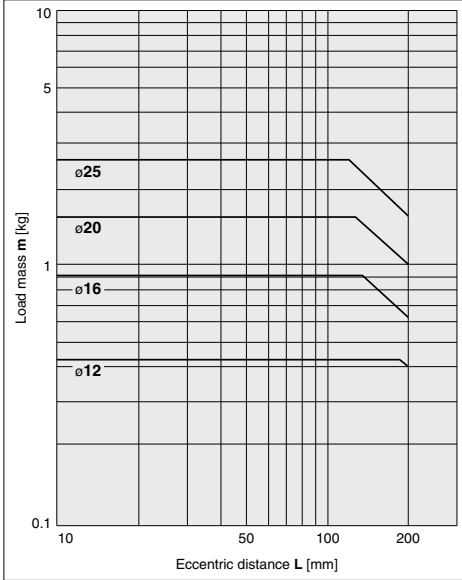

(10) Over 30 stroke, $V = 400$ mm/s

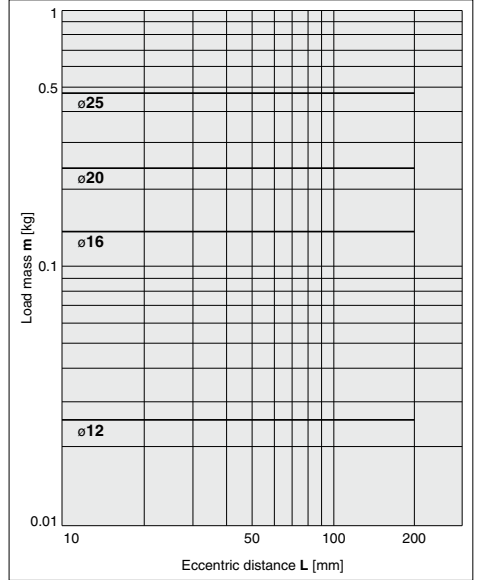

MGPL32 to 100, MGPA32 to 100

(11) 50 stroke or less, $V = 400$ mm/s

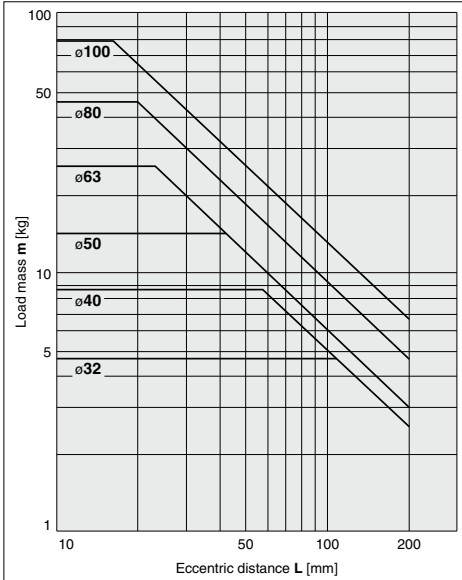

(12) Over 50 stroke, $V = 400$ mm/s

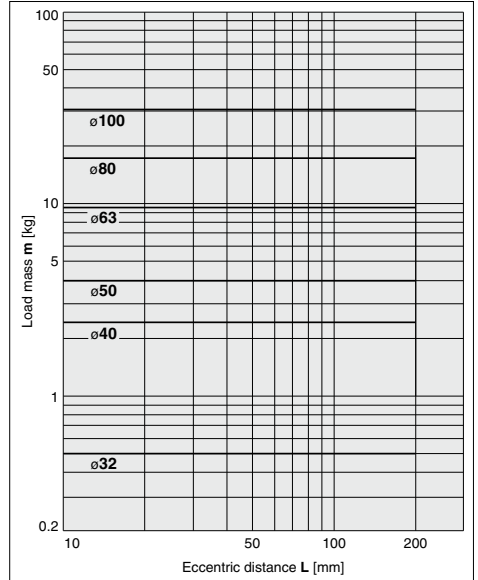

· Use the Guide Cylinder Selection Software, when the eccentric distance is 200 mm or more.

Horizontal Mounting **Slide Bearing**

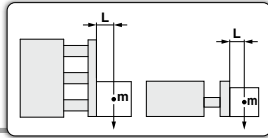

MGPM12 to 100

(13) L = 50 mm, V = 200 mm/s or less

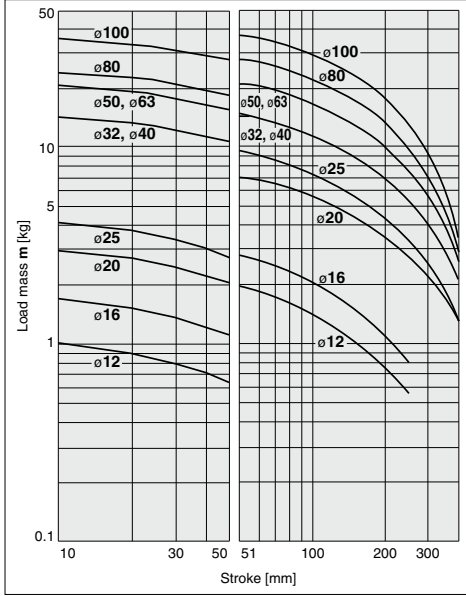

(14) L = 100 mm, V = 200 mm/s or less

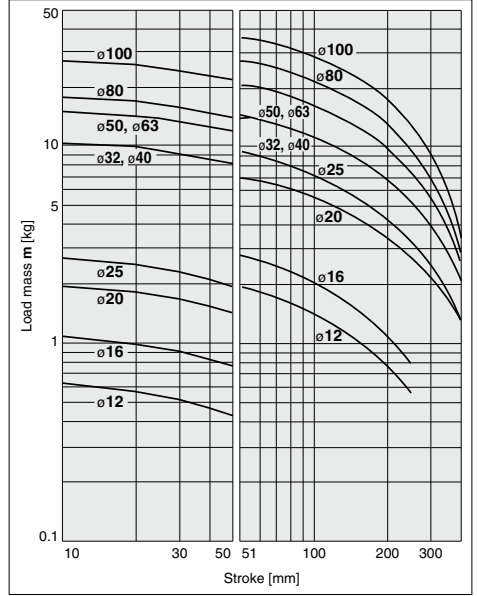

(15) L = 50 mm, V = 400 mm/s

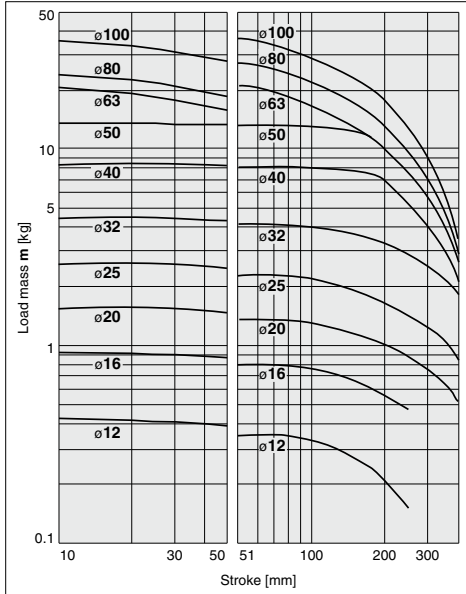

(16) L = 100 mm, V = 400 mm/s

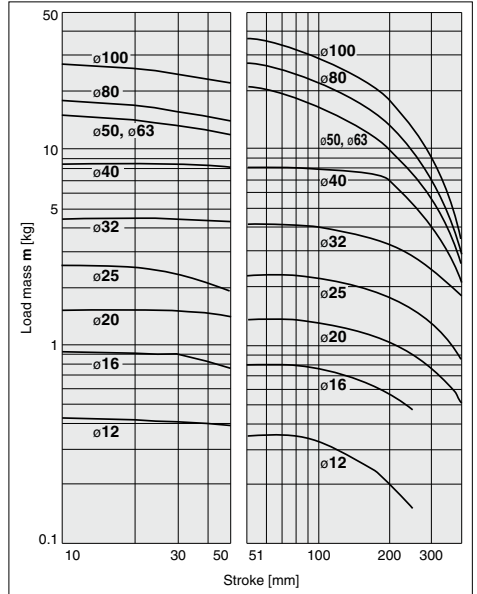

MGP Series

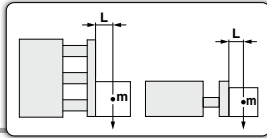

Horizontal Mounting **Ball Bushing**

(17) L = 50 mm, V = 200 mm/s or less

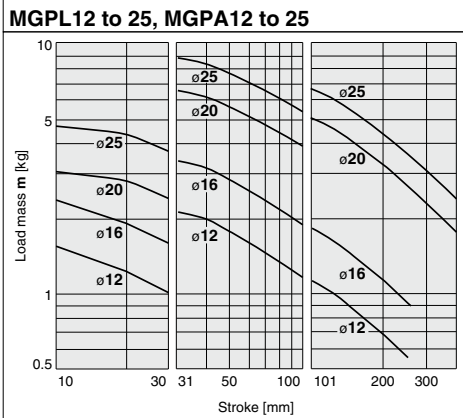

(18) L = 100 mm, V = 200 mm/s or less

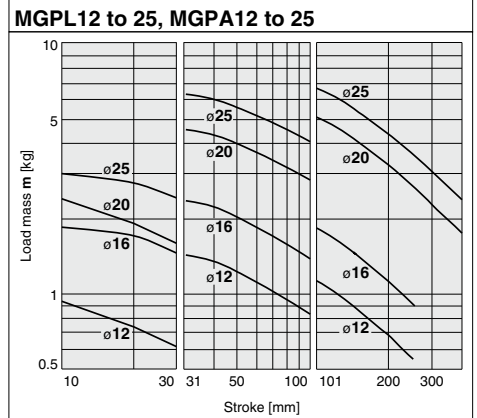

MGPL32 to 63, MGPA32 to 63

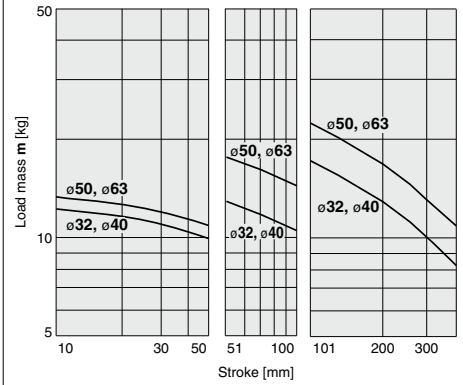

MGPL32 to 63, MGPA32 to 63

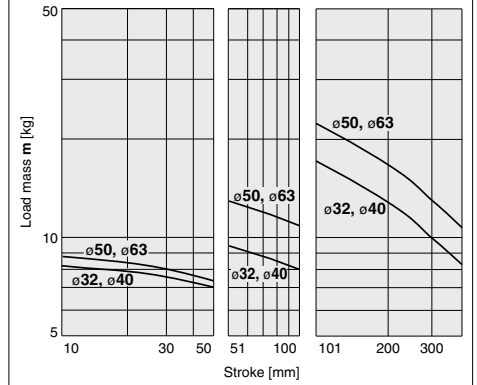

MGPL80/100, MGPA80/100

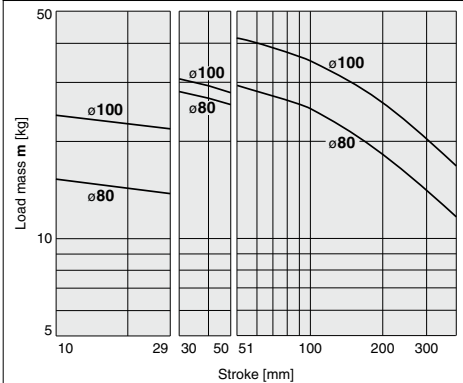

MGPL80/100, MGPA80/100

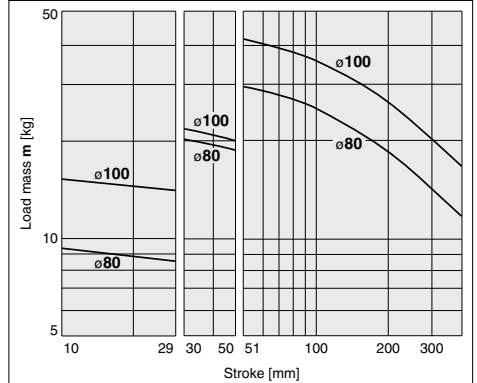

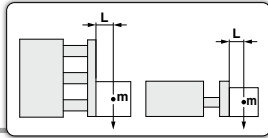

Horizontal Mounting Ball Bushing

(19) L = 50 mm, V = 400 mm/s

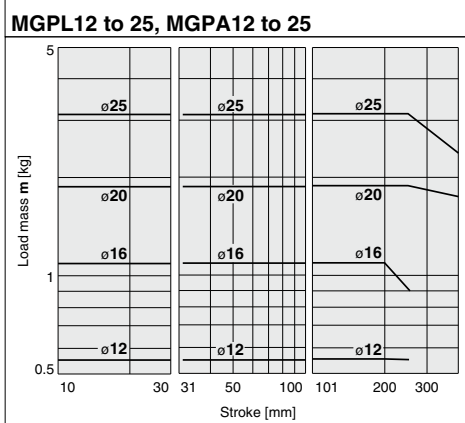

(20) L = 100 mm, V = 400 mm/s

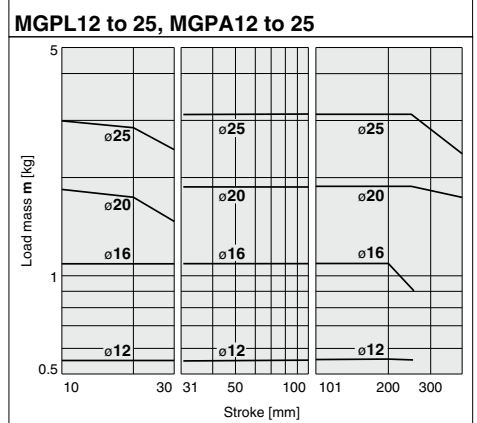

MGPL32 to 63, MGPA32 to 63

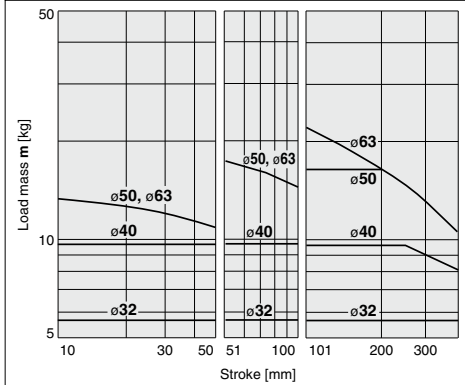

MGPL32 to 63, MGPA32 to 63

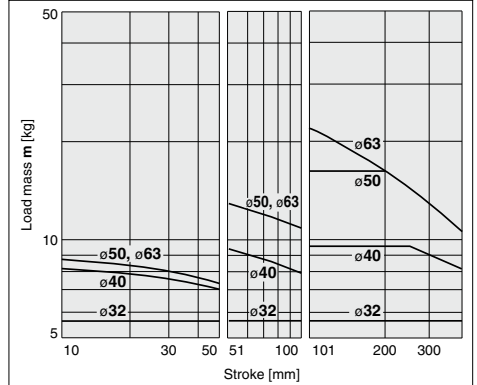

MGPL80/100, MGPA80/100

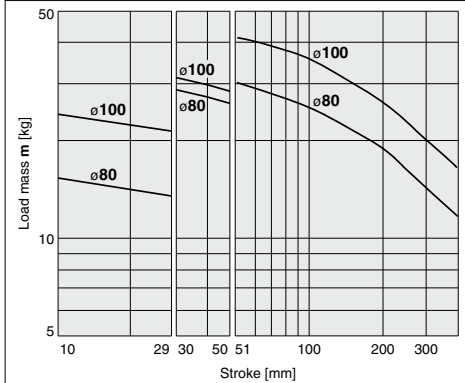

MGPL80/100, MGPA80/100

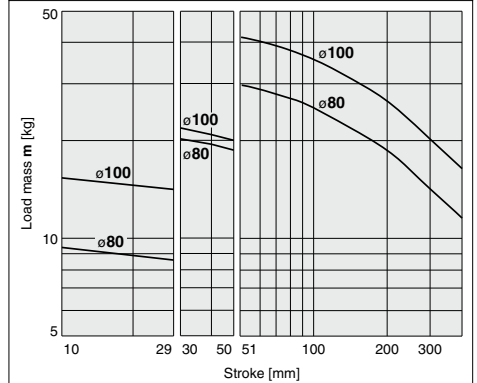

Operating Range when Used as Stopper

Bore Size: $\phi 12$ to $\phi 25$ /MGPM12 to 25 (Slide Bearing)

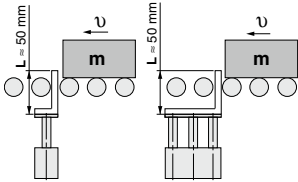

*: When selecting a model with a longer L dimension, be sure to choose a bore size which is sufficiently large.

⚠ Caution

Caution on handling

1. When using as a stopper, select a model with 30 stroke or less.
2. The MGPL (Ball bushing) and the MGPA (High precision ball bushing) cannot be used as a stopper.

MGPM12 to 25 (Slide Bearing)

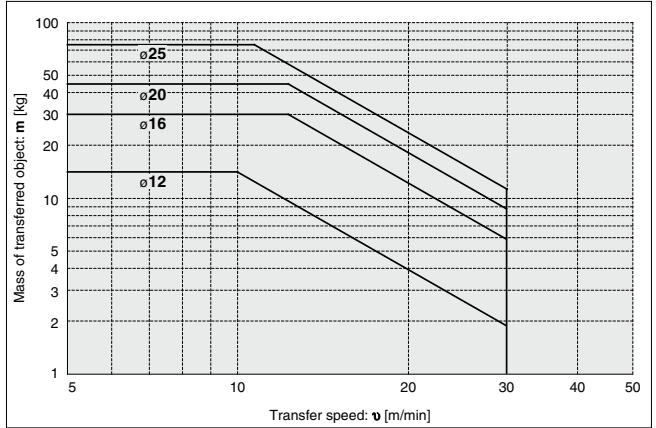

Bore Size: $\phi 32$ to $\phi 100$ /MGPM32 to 100 (Slide Bearing)

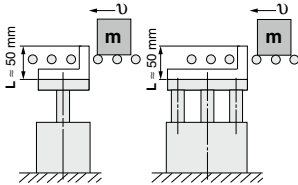

*: When selecting a model with a longer L dimension, be sure to choose a bore size which is sufficiently large.

⚠ Caution

Caution on handling

1. When using as a stopper, select a model with 50 stroke or less.
2. The MGPL (Ball bushing) and the MGPA (High precision ball bushing) cannot be used as a stopper.

MGPM32 to 100 (Slide Bearing)

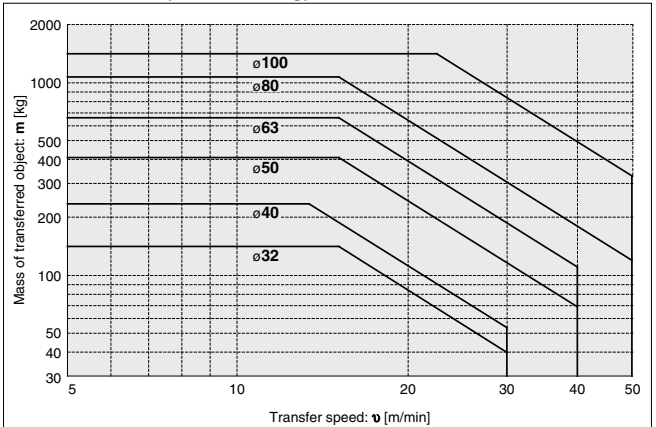

*: Refer to graphs (13) and (15) if line pressure is applied by a roller conveyor after the workpiece is stopped.

Construction/MGPM Series

MGPM12 to 25

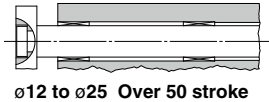
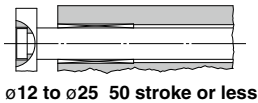
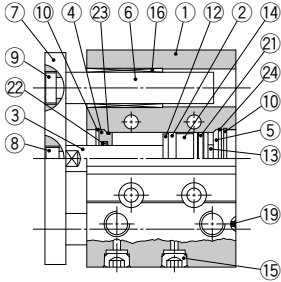

MGPM32 to 100

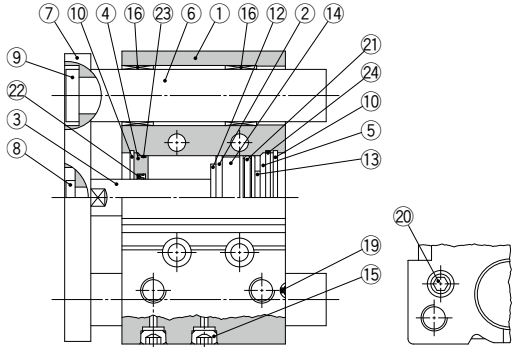

ø63 or more

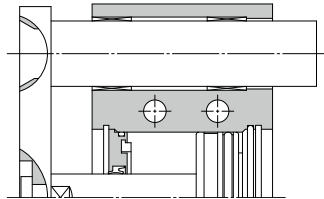

Component Parts

No.	Description	Material	Note
1	Body	Aluminum alloy	Hard anodized
2	Piston	Aluminum alloy	
3	Piston rod	Stainless steel	ø12 to ø25
4	Collar	Carbon steel	ø32 to ø100 Hard chrome plating
5	Head cover	Aluminum alloy	Chromated ø12 to ø63 Painted ø80, ø100
6	Guide rod	Carbon steel	Hard chrome plating
7	Plate	Carbon steel	Nickel plating
8	Plate mounting bolt	Carbon steel	Nickel plating
9	Guide bolt	Carbon steel	Nickel plating
10	Retaining ring	Carbon tool steel	Phosphate coated
11	Retaining ring	Carbon tool steel	Phosphate coated
12	Bumper A	Urethane	
13	Bumper B	Urethane	
14	Magnet	—	
15	Plug	Carbon steel	ø12, ø16 Nickel plating ø20 to ø100
16	Slide bearing	Bearing alloy	

** : A felt is not installed on the slide bearing.

Component Parts

No.	Description	Material	Note
17	Ball bushing	Aluminum alloy	
18	Spacer	Aluminum alloy	
19	Steel ball	Carbon steel	ø12 to ø50
20	Plug	Carbon steel	ø63 to ø100 Nickel plating
21*	Piston seal	NBR	
22*	Rod seal	NBR	
23*	Gasket A	NBR	
24*	Gasket B	NBR	

Replacement Parts/Seal Kit

Bore size [mm]	Kit no.	Contents	Bore size [mm]	Kit no.	Contents
12	MGP12-Z-PS	Set of nos.	40	MGP40-Z-PS	Set of nos.
16	MGP16-Z-PS	above	50	MGP50-Z-PS	above
20	MGP20-Z-PS	ø1, ø2, ø3, ø4	63	MGP63-Z-PS	ø1, ø2, ø3, ø4
25	MGP25-Z-PS	ø3, ø4	80	MGP80-Z-PS	ø3, ø4
32	MGP32-Z-PS		100	MGP100-Z-PS	

*: Seal kit includes 21 to 24. Order the seal kit, based on each bore size.

*: Since the seal kit does not include a grease pack, order it separately.

Grease pack part number: GR-S-010 (10 g)

MGP Series

Construction/MGPL Series, MGPA Series

MGPL12 to 25
MGPA12 to 25

MGPL32 to 100
MGPA32 to 100

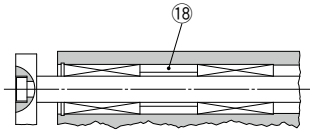
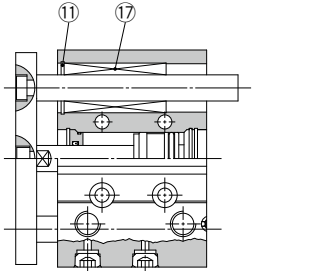

$\phi 12$ to $\phi 25$ Over 100 stroke

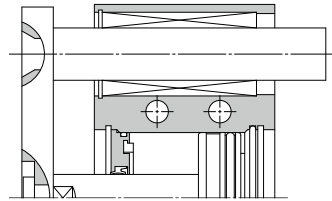
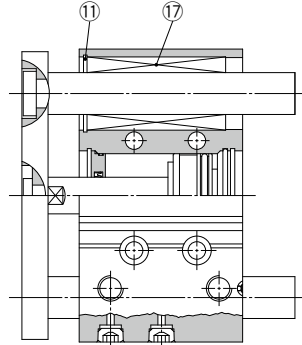

$\phi 50$ or more

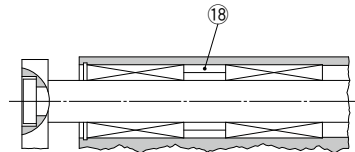

$\phi 32$ to $\phi 63$ Over 100 stroke
 $\phi 80$, $\phi 100$ Over 200 stroke

ø12 to ø25/MGPM, MGPL, MGPA

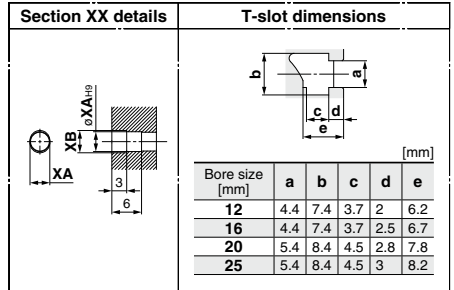
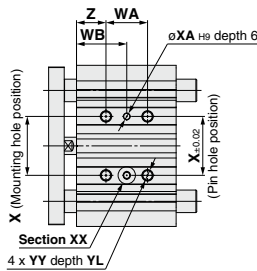
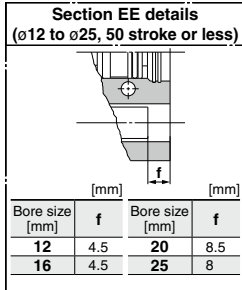

Bottom view

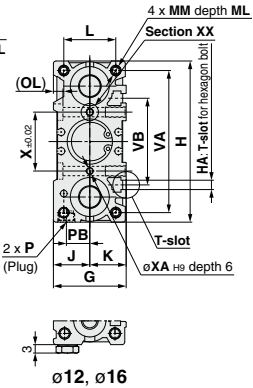
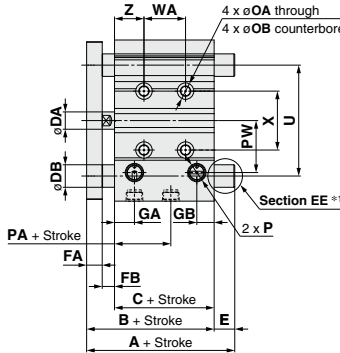
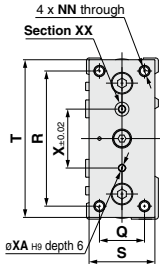

*1: Refer to Section EE details for the shape of ø12 to ø25 with stroke of 50 or less.

*2: The use of a slot (width XA, length XB, depth 3) allows for a relaxed pin pitch tolerance, with the pin hole (øXA_{Hø}, depth 6) as the reference, without affecting mounting accuracy.

*3: For intermediate strokes other than standard strokes, refer to Manufacture of Intermediate Strokes on page 537.

*4: For bore size ø12 and ø16, only M5 x 0.8 port is available.

*5: For bore size ø20 or more, choice of Rc, NPT, G port is available. (Refer to page 536.)

MGPM, MGPL, MGPA Common Dimensions

Bore size [mm]	Standard stroke [mm]	B	C	DA	FA	FB	G	GA	GB	H	HA	J	K	L	MM	ML	NN	OA	OB	OL	P			
																					Nil	TN	TF	
12	10, 20, 30, 40, 50, 75, 100	42	29	6	7	6	26	10	7	58	M4	13	13	18	M4 x 0.7	10	M4 x 0.7	4.3	8	4.5	M5 x 0.8	—	—	—
16	125, 150, 175, 200, 250	46	33	8	7	6	30	10.5	7.5	64	M4	15	15	22	M5 x 0.8	12	M5 x 0.8	4.3	8	4.5	M5 x 0.8	—	—	—
20	20, 30, 40, 50, 75, 100, 125, 150	53	37	10	8	8	36	11.5	9	83	M5	18	18	24	M5 x 0.8	13	M5 x 0.8	5.4	9.5	5.5	Rc1/8	NPT1/8	G1/8	
25	175, 200, 250, 300, 350, 400	53.5	37.5	10	9	7	42	11.5	10	93	M5	21	21	30	M6 x 1.0	15	M6 x 1.0	5.4	9.5	5.5	Rc1/8	NPT1/8	G1/8	

Bore size [mm]	PA	PB	PW	Q	R	S	T	U	VA	VB	WA					WB					X	XA	XB	YY	YL	Z
											30 st or less	Over 30 st or less	Over 100 st or less	Over 200 st or less	Over 300 st or less	30 st or less	Over 30 st or less	Over 100 st or less	Over 200 st or less	Over 300 st or less						
12	13	8	18	14	48	22	56	41	50	37	20	40	110	200	—	15	25	60	105	—	23	3	3.5	M5 x 0.8	10	5
16	14.5	10	19	16	54	25	62	46	56	38	24	44	110	200	—	17	27	60	105	—	24	3	3.5	M5 x 0.8	10	5
20	13.5	10.5	25	18	70	30	81	54	72	44	24	44	120	200	300	29	39	77	117	167	28	3	3.5	M6 x 1.0	12	17
25	12.5	13.5	30	26	78	38	91	64	82	50	24	44	120	200	300	29	39	77	117	167	34	4	4.5	M6 x 1.0	12	17

MGPL (Ball bushing)

MGPM (Slide bearing) A, DB, E Dimensions

MGPA (High precision ball bushing) A, DB, E Dimensions

Bore size [mm]	A				DB	E			
	50 st or less	Over 50 st or less	Over 100 st or less	Over 200 st or less		50 st or less	Over 50 st or less	Over 100 st or less	Over 200 st or less
12	42	60.5	82.5	82.5	8	0	18.5	40.5	40.5
16	46	64.5	92.5	92.5	10	0	18.5	46.5	46.5
20	53	77.5	77.5	110	12	0	24.5	24.5	57
25	53.5	77.5	77.5	109.5	16	0	24	24	56

Bore size [mm]	A				DB	E			
	30 st or less	Over 30 st or less	Over 100 st or less	Over 200 st or less		30 st or less	Over 30 st or less	Over 100 st or less	Over 200 st or less
12	43	55	84.5	84.5	6	1	13	42.5	42.5
16	49	65	94.5	94.5	8	3	19	48.5	48.5
20	59	76	100	117.5	10	6	23	47	64.5
25	65.5	81.5	100.5	117.5	13	12	28	47	64

Ø32 to Ø63/MGPM, MGPL, MGPA

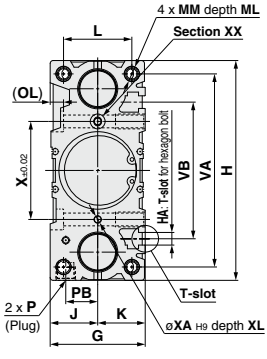
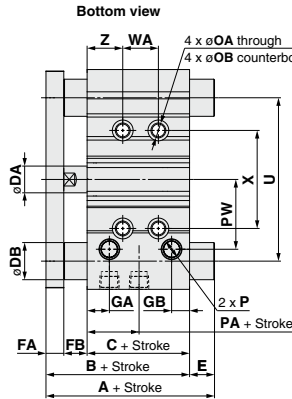
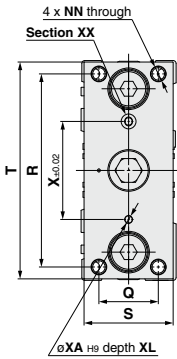
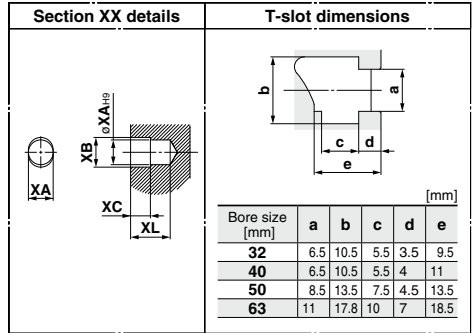
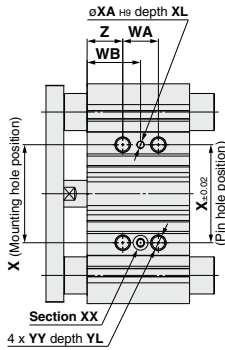

- *: The use of a slot (width XA, length XB, depth XC) allows for a relaxed pin pitch tolerance, with the pin hole (ØXA_{H9}, depth XL) as the reference, without affecting mounting accuracy.
- *: For intermediate strokes other than standard strokes, refer to Manufacture of Intermediate Strokes on page 537.
- *: Choice of Rc, NPT, G port is available. (Refer to page 536.)

MGPM, MGPL, MGPA Common Dimensions [mm]

Bore size [mm]	Standard stroke [mm]	B	C	DA	FA	FB	G	GA	GB	H	HA	J	K	L	MM	ML	NN	OA	OB	OL	P		
																					Nil	TN	TF
32	25, 50, 75	59.5	37.5	14	10	12	48	12	9	112	M6	24	24	34	M8 x 1.25	20	M8 x 1.25	6.7	11	7.5	Rc1/8	NPT1/8	G1/8
40	100, 125, 150	66	44	14	10	12	54	15	12	120	M6	27	27	40	M8 x 1.25	20	M8 x 1.25	6.7	11	7.5	Rc1/8	NPT1/8	G1/8
50	175, 200, 250	72	44	18	12	16	64	15	12	148	M8	32	32	46	M10 x 1.5	22	M10 x 1.5	8.6	14	9	Rc1/4	NPT1/4	G1/4
63	300, 350, 400	77	49	18	12	16	78	15.5	13.5	162	M10	39	39	58	M10 x 1.5	22	M10 x 1.5	8.6	—	9	Rc1/4	NPT1/4	G1/4

Bore size [mm]	PA	PB	PW	Q	R	S	T	U	VA	VB	WA						WB						X	XA	XB	XC	XL	YY	YL	Z
											25 at or less	Over 25 st	Over 100 at	Over 200 at	Over 300 at	25 at or less	Over 25 st	Over 100 at	Over 200 at	Over 300 at	25 at or less	Over 25 st								
32	6.5	16	35.5	30	96	44	110	78	98	63	24	48	124	200	300	33	45	83	121	171	42	4	4.5	3	6	M8 x 1.25	16	21		
40	13	18	39.5	30	104	44	118	86	106	72	24	48	124	200	300	34	46	84	122	172	50	4	4.5	3	6	M8 x 1.25	16	22		
50	9	21.5	47	40	130	60	146	110	130	92	24	48	124	200	300	36	48	86	124	174	66	5	6	4	8	M10 x 1.5	20	24		
63	13	28	58	50	130	70	158	124	142	110	28	52	128	200	300	38	50	88	124	174	80	5	6	4	8	M10 x 1.5	20	24		

MGPL (Ball bushing)

MGPM (Slide bearing) A, DB, E Dimensions [mm]

MGPA (High precision ball bushing) A, DB, E Dimensions [mm]

Bore size [mm]	A			DB	E		
	50 at or less	Over 50 at 200 at or less	Over 200 at		50 at or less	Over 50 at 200 at or less	Over 200 at
32	75	93.5	129.5	20	15.5	34	70
40	75	93.5	129.5	20	9	27.5	63.5
50	88.5	109.5	150.5	25	16.5	37.5	78.5
63	88.5	109.5	150.5	25	11.5	32.5	73.5

Bore size [mm]	A				DB	E			
	50 at or less	Over 50 at 100 at or less	Over 100 at 200 at or less	Over 200 at		50 at or less	Over 50 at 100 at or less	Over 100 at 200 at or less	Over 200 at
32	79.5	96.5	116.5	138.5	16	20	37	57	79
40	79.5	96.5	116.5	138.5	16	13.5	30.5	50	72.5
50	91.5	112.5	132.5	159.5	20	19.5	40.5	60.5	87.5
63	91.5	112.5	132.5	159.5	20	14.5	35.5	55.5	82.5

ø80, ø100/MGPM, MGPL, MGPA

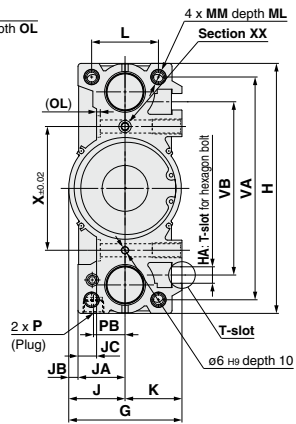
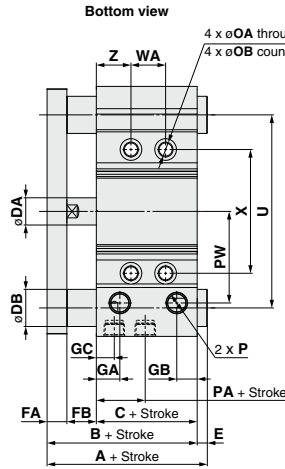
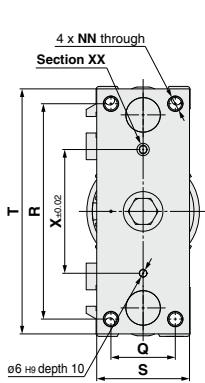
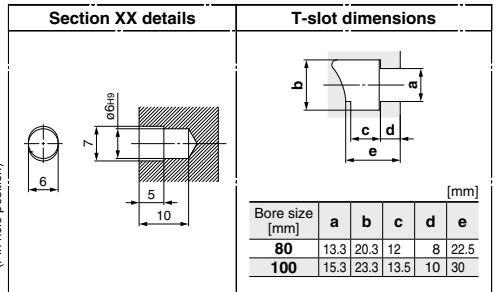
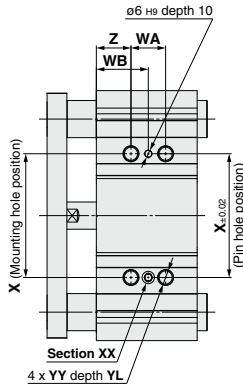

- *: The use of a slot (width X6, length 7, depth 5) allows for a relaxed pin pitch tolerance, with the pin hole (ø6H9, depth 10) as the reference, without affecting mounting accuracy.
- *: For intermediate strokes other than standard strokes, refer to Manufacture of Intermediate Strokes on page 537.
- *: Choice of Rc, NPT, G port is available. (Refer to page 536.)

MGPM, MGPL, MGPA Common Dimensions [mm]

Bore size [mm]	Standard stroke [mm]	B	C	DA	FA	FB	G	GA	GB	GC	H	HA	J	JA	JB	JC	K	L	MM	ML	NN	OA	OB	OL	P		
																									Nil	TN	TF
80	25, 50, 75, 100 125, 150, 175, 200 250, 300, 350, 400	96.5	56.5	22	16	24	91.5	19	16.5	14.5	202	M12	45.5	38	7.5	15	46	54	M12 x 1.75	25	M12 x 1.75	10.6	17.5	3	Rc3/8	NPT3/8	G3/8
100		116	66	26	19	31	111.5	22.5	20.5	18	240	M14	55.5	45	10.5	10	56	62	M14 x 2.0	31	M14 x 2.0	12.5	20	8	Rc3/8	NPT3/8	G3/8

Bore size [mm]	WA										WB										X	YY	YL	Z
	PA	PB	PW	Q	R	S	T	U	VA	VB	25 st or less	Over 25 st 100 st or less	Over 100 st 200 st or less	Over 200 st 300 st or less	Over 300 st	25 st or less	Over 25 st 50 st or less	Over 50 st 100 st or less	Over 100 st 200 st or less	Over 200 st 300 st or less				
80	14.5	25.5	74	52	174	75	198	156	180	140	28	52	128	200	300	42	54	92	128	178	100	M12 x 1.75	24	28
100	17.5	32.5	89	64	210	90	236	188	210	166	48	72	148	220	320	35	47	85	121	171	124	M14 x 2.0	28	11

MGPL (Ball bushing)

MGPA (High precision ball bushing) A, DB, E Dimensions [mm]

MGPM (Slide bearing) A, DB, E Dimensions [mm]

Bore size [mm]	A			DB	E			Bore size [mm]	A			DB	E				
	50 st or less	Over 50 st 200 st or less	Over 200 st		50 st or less	Over 50 st 200 st or less	Over 200 st		25 st or less	Over 25 st 50 st or less	Over 50 st 100 st or less		Over 100 st 200 st or less	Over 200 st	25 st or less	Over 25 st 50 st or less	Over 50 st 100 st or less
80	104.5	131.5	180.5	30	8	35	84	80	104.5	128.5	158.5	191.5	25	8	32	62	95
100	126.5	151.5	190.5	36	10.5	35.5	74.5	100	119.5	145.5	178.5	201.5	30	3.5	29.5	62.5	85.5

Compact Guide Cylinder With Air Cushion

MGP Series

ø16, ø20, ø25, ø32, ø40, ø50, ø63, ø80, ø100

How to Order

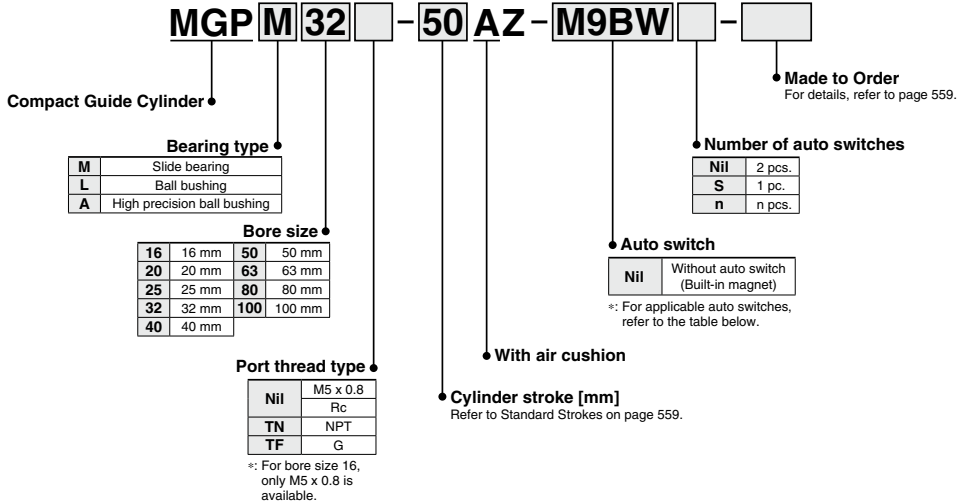

Applicable Auto Switches/Refer to pages 1289 to 1383 for further information on auto switches.

Type	Special function	Electrical entry	Indicator light	Wiring (Output)	Load voltage		Auto switch model		Lead wire length [m]			Pre-wired connector	Applicable load								
					DC	AC	Perpendicular	In-line	0.5 (Nil)	1 (M)	3 (L)			5 (Z)							
Solid state auto switch	—	Grommet	Yes	3-wire (NPN)	5 V, 12 V	—	M9NV	M9N	●	●	○	○	IC circuit	Relay, PLC							
				3-wire (PNP)			M9PV	M9P	●	●	○	○									
				2-wire	M9BV		M9B	●	●	○	○										
	3-wire (NPN)			5 V, 12 V	M9NWW		M9NWX	●	●	○	○										
	3-wire (PNP)				M9PWW		M9PW	●	●	○	○										
	2-wire			12 V	M9BWW		M9BW	●	●	○	○										
Water resistant (2-color indicator)	—	Grommet	Yes	3-wire (NPN)	5 V, 12 V	—	M9NAV ^{*1}	M9NA ^{*1}	○	○	●	○	IC circuit	Relay, PLC							
				3-wire (PNP)			M9PAV ^{*1}	M9PA ^{*1}	○	○	●	○									
				2-wire	M9BAV ^{*1}		M9BA ^{*1}	○	○	●	○										
Magnetic field resistant (2-color indicator)	—			Grommet	No		2-wire (Non-polar)	—	—	—	P3DWA ^{*2}	●	—		●	●	—	Relay, PLC			
							3-wire (NPN equivalent)	24 V		12 V	100 V	A96V	A96		●	—			●	—	IC circuit
												A93V ^{*3}	A93		●	—			●	—	
2-wire	—	100 V or less	A90V			A90	●	—		●	—	—	—	IC circuit							

*1: Water resistant type auto switches are mountable on the above models, but in such case SMC cannot guarantee water resistance.

A water resistant type cylinder is recommended for use in an environment which requires water resistance.

However, please contact SMC for water resistant products of ø12 and ø16.

*2: The D-P3DWA□ is mountable on bore size ø25 to ø100.

*3: 1 m type lead wire is only applicable to the D-A93.

*: Lead wire length symbols: 0.5 m.....Nil (Example) M9NW
1 m.....M (Example) M9NWM
3 m.....L (Example) M9NWL
5 m.....Z (Example) M9NWX

*: Solid state auto switches marked with "○" are produced upon receipt of order.

*: Other than the auto switches listed above, the D-P4DW type can be mounted. Refer to page 595 for details.

*: For details about auto switches with pre-wired connector, refer to pages 1358 and 1359.

*: Auto switches are shipped together, (but not assembled).

Specifications

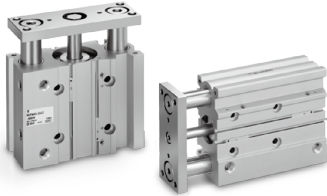

Symbol
Air cushion

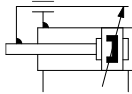

Bore size [mm]	16	20	25	32	40	50	63	80	100
Action	Double acting								
Fluid	Air								
Proof pressure	1.5 MPa								
Maximum operating pressure	1.0 MPa								
Minimum operating pressure	0.15 MPa	0.12 MPa							
Ambient and fluid temperature	-10 to 60°C (No freezing)								
Piston speed *1	50 to 500 mm/s							50 to 400 mm/s	
Cushion	Air cushion on both ends (Without bumper)								
Lubrication	Not required (Non-lube)								
Stroke length tolerance	$\begin{matrix} +1.5 \\ 0 \end{matrix}$ mm								

*1: Maximum speed with no load. Depending on the operating conditions, the piston speed may not be satisfied. Make a model selection, considering a load according to the graph on pages 562 to 568.

Standard Strokes

Bore size [mm]	Standard stroke [mm]
16	25, 50, 75, 100, 125, 150, 175, 200, 250
20 to 63	25, 50, 75, 100, 125, 150, 175, 200, 250, 300, 350, 400
80, 100	50, 75, 100, 125, 150, 175, 200, 250, 300, 350, 400

Manufacture of Intermediate Strokes



Made to Order: Individual Specifications
(For details, refer to pages 597 and 598.)

Symbol	Specifications
-X867	Side porting type (Plug location changed)



Made to Order
[Click here for details](#)

Symbol	Specifications
-XA□	Change of guide rod end shape
-XC19	Intermediate stroke (Spacer type)
-XC79	Tapped hole, drilled hole, pinned hole machined additionally
-XC85	Grease for food processing equipment

Description	Intermediate strokes in 1 mm increments are available by replacing collars of a standard stroke cylinder. Minimum manufacturable stroke $\phi 16$ to $\phi 63$: 15 mm $\phi 80$, $\phi 100$: 20 mm Select a rubber bumper type, because the cushion effect is not obtainable for less than this stroke.																
Model no.	Add "-XC19" to the end of standard part number.																
Applicable stroke [mm]	<table border="1"> <thead> <tr> <th>Stroke</th> <th>16 to 249</th> <th>15 to 399</th> <th>20 to 399</th> </tr> </thead> <tbody> <tr> <td>$\phi 16$</td> <td>15 to 249</td> <td>15 to 399</td> <td>20 to 399</td> </tr> <tr> <td>$\phi 20$ to $\phi 63$</td> <td>15 to 399</td> <td>15 to 399</td> <td>20 to 399</td> </tr> <tr> <td>$\phi 80$, $\phi 100$</td> <td>20 to 399</td> <td>20 to 399</td> <td>20 to 399</td> </tr> </tbody> </table>	Stroke	16 to 249	15 to 399	20 to 399	$\phi 16$	15 to 249	15 to 399	20 to 399	$\phi 20$ to $\phi 63$	15 to 399	15 to 399	20 to 399	$\phi 80$, $\phi 100$	20 to 399	20 to 399	20 to 399
Stroke	16 to 249	15 to 399	20 to 399														
$\phi 16$	15 to 249	15 to 399	20 to 399														
$\phi 20$ to $\phi 63$	15 to 399	15 to 399	20 to 399														
$\phi 80$, $\phi 100$	20 to 399	20 to 399	20 to 399														
Example	Part no.: MGP20-35AZ-XC19 A collar 15 mm in width is installed in the MGP20-50AZ. C dimension is 112 mm.																

*: Intermediate stroke (in 1 mm increments) based on an exclusive body will be available upon request for special.

Refer to pages 592 to 596 for cylinders with auto switches.

- Auto switch proper mounting position (detection at stroke end) and its mounting height
- Minimum stroke for auto switch mounting
- Operating range
- Auto switch mounting brackets/Part no.
- Auto Switch Mounting

Theoretical Output



Bore size [mm]	Rod size [mm]	Operating direction	Piston area [mm ²]	Operating pressure [MPa]										
				0.2	0.3	0.4	0.5	0.6	0.7	0.8	0.9	1.0		
16	8	OUT	201	40	60	80	101	121	141	161	181	201		
		IN	151	30	45	60	75	90	106	121	136	151		
20	10	OUT	314	63	94	126	157	188	220	251	283	314		
		IN	236	47	71	94	118	141	165	188	212	236		
25	10	OUT	491	98	147	196	245	295	344	393	442	491		
		IN	412	82	124	165	206	247	289	330	371	412		
32	14	OUT	804	161	241	322	402	483	563	643	724	804		
		IN	650	130	195	260	325	390	455	520	585	650		
40	14	OUT	1257	251	377	503	628	754	880	1005	1131	1257		
		IN	1103	221	331	441	551	662	772	882	992	1103		
50	20	OUT	1963	393	589	785	982	1178	1374	1571	1767	1963		
		IN	1649	330	495	660	825	990	1154	1319	1484	1649		
63	20	OUT	3117	623	935	1247	1559	1870	2182	2494	2806	3117		
		IN	2803	561	841	1121	1402	1682	1962	2242	2523	2803		
80	25	OUT	5027	1005	1508	2011	2513	3016	3519	4021	4524	5027		
		IN	4536	907	1361	1814	2268	2722	3175	3629	4082	4536		
100	30	OUT	7854	1571	2356	3142	3927	4712	5498	6283	7069	7854		
		IN	7147	1429	2144	2859	3574	4288	5003	5718	6432	7147		

*: Theoretical output [N] = Pressure [MPa] x Piston area [mm²]

MGP Series

Weights

Slide Bearing: MGPM16 to 100 [kg]

Bore size [mm]	Standard stroke [mm]											
	25	50	75	100	125	150	175	200	250	300	350	400
16	0.48	0.62	0.74	0.86	1.01	1.14	1.26	1.38	1.62	—	—	—
20	0.78	1.02	1.20	1.39	1.57	1.75	1.94	2.12	2.55	2.92	3.29	3.65
25	1.07	1.43	1.67	1.92	2.17	2.41	2.66	2.91	3.50	4.00	4.49	4.99
32	1.65	2.10	2.45	2.81	3.16	3.52	3.87	4.23	5.11	5.82	6.53	7.24
40	1.95	2.43	2.83	3.22	3.61	4.00	4.40	4.79	5.75	6.54	7.32	8.10
50	3.28	4.03	4.63	5.22	5.82	6.41	7.00	7.60	9.10	10.29	11.48	12.67
63	4.13	4.97	5.65	6.34	7.02	7.71	8.39	9.07	10.76	12.13	13.50	14.86
80	—	7.48	8.36	9.24	10.12	11.00	11.88	12.76	15.06	16.82	18.58	20.33
100	—	12.13	13.40	14.67	15.94	17.21	18.48	19.75	22.92	25.46	28.00	30.55

Ball Bushing: MGPL16 to 100, High Precision Ball Bushing: MGPA16 to 100 [kg]

Bore size [mm]	Standard stroke [mm]											
	25	50	75	100	125	150	175	200	250	300	350	400
16	0.48	0.59	0.69	0.84	0.94	1.05	1.15	1.25	1.46	—	—	—
20	0.82	0.98	1.14	1.35	1.51	1.67	1.82	1.98	2.34	2.65	2.97	3.29
25	1.16	1.36	1.57	1.83	2.03	2.24	2.44	2.65	3.11	3.52	3.93	4.34
32	1.59	2.01	2.29	2.67	2.95	3.24	3.53	3.81	4.48	5.05	5.61	6.18
40	1.87	2.33	2.65	3.07	3.39	3.71	4.04	4.36	5.10	5.74	6.38	7.03
50	3.10	3.82	4.32	4.93	5.43	5.93	6.43	6.93	8.10	9.10	10.10	11.09
63	3.95	4.75	5.35	6.06	6.66	7.25	7.84	8.44	9.79	10.98	12.17	13.36
80	—	7.63	8.38	9.12	9.87	10.62	11.37	12.11	14.03	15.52	17.02	18.51
100	—	12.07	13.17	14.28	15.38	16.49	17.59	18.70	21.32	23.53	25.74	27.95

Allowable Rotational Torque of Plate

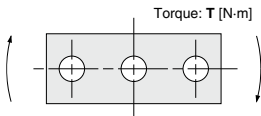

Bore size [mm]	Bearing type	Stroke											
		25	50	75	100	125	150	175	200	250	300	350	400
16	MGPM	0.53	0.84	0.69	0.58	0.50	0.44	0.40	0.36	0.30	—	—	—
	MGPL/A	1.27	0.86	0.65	0.52	0.43	0.37	0.32	0.28	0.23	—	—	—
20	MGPM	0.99	2.23	1.88	1.63	1.44	1.28	1.16	1.06	0.90	0.78	0.69	0.62
	MGPL/A	2.66	1.94	1.52	1.34	1.17	1.03	0.93	0.76	0.65	0.56	0.49	0.49
25	MGPM	1.64	3.51	2.96	2.57	2.26	2.02	1.83	1.67	1.42	1.24	1.09	0.98
	MGPL/A	4.08	3.02	2.38	2.41	2.05	1.78	1.58	1.41	1.16	0.98	0.85	0.74
32	MGPM	6.35	6.64	5.69	4.97	4.42	3.98	3.61	3.31	2.84	2.48	2.20	1.98
	MGPL/A	5.95	5.89	5.11	6.99	6.34	5.79	5.33	4.93	4.29	3.78	3.38	3.04
40	MGPM	7.00	7.32	6.27	5.48	4.87	4.38	3.98	3.65	3.13	2.74	2.43	2.19
	MGPL/A	6.55	6.49	5.62	7.70	6.98	6.38	5.87	5.43	4.72	4.16	3.71	3.35
50	MGPM	13.0	13.8	12.0	10.6	9.50	8.60	7.86	7.24	6.24	5.49	4.90	4.43
	MGPL/A	9.17	11.2	9.80	12.8	11.6	10.7	9.80	9.10	7.95	7.02	6.26	5.63
63	MGPM	14.7	15.6	13.5	11.9	10.7	9.69	8.86	8.16	7.04	6.19	5.52	4.99
	MGPL/A	10.2	12.5	11.0	14.3	13.0	11.9	11.0	10.2	8.84	7.80	6.64	6.24
80	MGPM	—	26.0	22.9	20.5	18.6	17.0	15.6	14.5	12.6	11.2	10.0	9.11
	MGPL/A	—	25.2	22.7	20.6	18.9	17.3	16.0	14.8	12.9	11.3	10.0	8.94
100	MGPM	—	41.9	37.5	33.8	30.9	28.4	26.2	24.4	21.4	19.1	17.2	15.7
	MGPL/A	—	41.7	37.9	34.6	31.8	29.3	27.2	25.3	22.1	19.5	17.3	15.5

High Precision Ball Bushing/MGPA

⚠ Caution

Positioning accuracy for pin hole on the plate
Dispersion of dimensions when machining each component will be accumulated in the plate pin hole positioning accuracy when mounting this cylinder. Values below are referred as a guide.

[Side mounting]

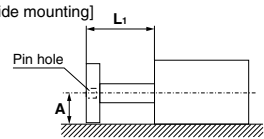

$$A = [\text{Catalog dimension}] \pm \overset{\ast 1}{(0.1 + L_1 \times 0.0008)} \text{ [mm]}$$

*1: To be 0.15 for ø80, ø100

*: Displacement by load and self-weight deflection by plate and guide rod is included.

[Bottom mounting]

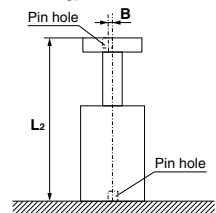

$$B = \pm (0.045 + L_2 \times 0.0016) \text{ [mm]}$$

Non-rotating Accuracy of Plate

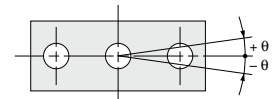

Non-rotating accuracy θ when retracted and when no load is applied should be not more than the values shown in the table.

Bore size [mm]	Non-rotating accuracy θ		
	MGPM	MGPL	MGPA
16	$\pm 0.07^\circ$	$\pm 0.05^\circ$	$\pm 0.01^\circ$
20	$\pm 0.06^\circ$	$\pm 0.04^\circ$	
25	$\pm 0.06^\circ$	$\pm 0.04^\circ$	
32	$\pm 0.05^\circ$	$\pm 0.03^\circ$	
40	$\pm 0.05^\circ$	$\pm 0.03^\circ$	
50	$\pm 0.04^\circ$	$\pm 0.03^\circ$	
63	$\pm 0.04^\circ$	$\pm 0.03^\circ$	
80	$\pm 0.03^\circ$	$\pm 0.03^\circ$	
100	$\pm 0.03^\circ$	$\pm 0.03^\circ$	

High Precision Ball Bushing/MGPA Plate Displacement Amount (Reference Values)

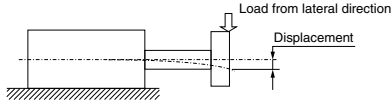

MGPA16

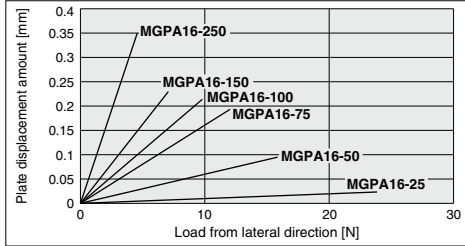

MGPA50, 63

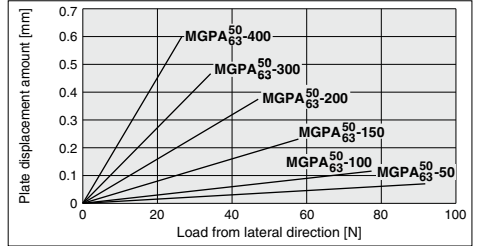

MGPA20

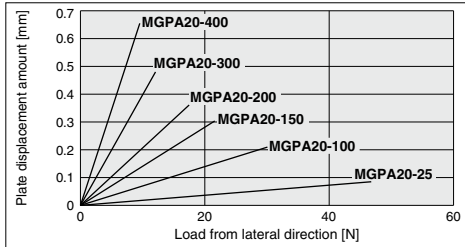

MGPA80

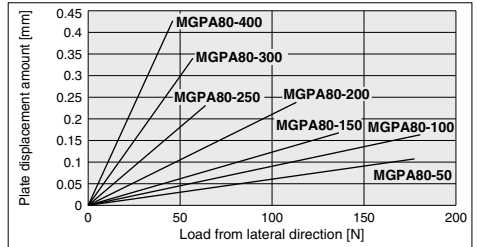

MGPA25

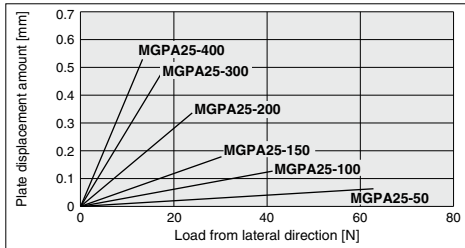

MGPA100

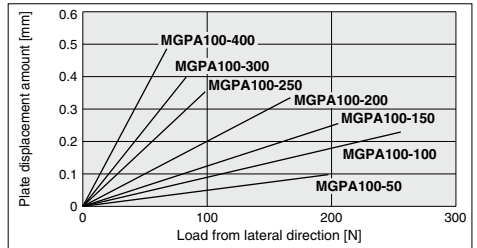

MGPA32, 40

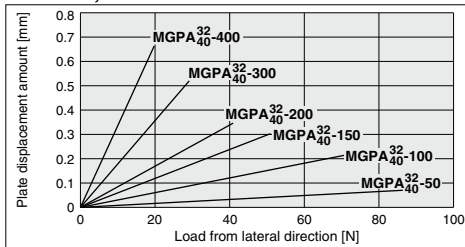

*: The guide rod and self-weight for the plate are not included in the above displacement values.
*: Allowable rotating torque, and operating range when used as a lifter, are the same as those of the MGPL series.

With Air Cushion MGP Series Model Selection

Selection Conditions

Mounting orientation	Vertical		Horizontal	
Maximum speed [mm/s]	200 or less	400	200 or less	400
Graph (Slide bearing)	(1), (2)	(3), (4)	(15), (16)	(17), (18)
Graph (Ball bushing)	(5) to (9)	(10) to (14)	(19), (20)	(21), (22)

Selection Example 1 (Vertical Mounting)

Selection conditions

Mounting: Vertical
Bearing type: Ball bushing
Stroke: 75 stroke
Maximum speed: 200 mm/s
Load mass: 7 kg
Eccentric distance: 70 mm

Find the point of intersection for the load mass of 7 kg and the eccentric distance of 70 mm on graph (5), based on vertical mounting, ball bushing, 75 mm stroke, and the speed of 200 mm/s.

→ **MGPL25-75AZ** is selected.

(5) 75 stroke or less, $V = 200$ mm/s or less

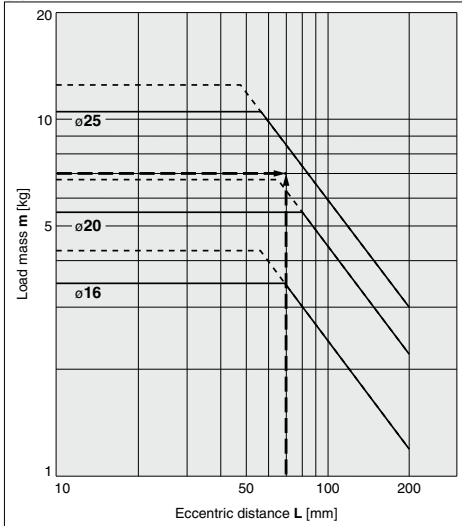

Selection Example 2 (Horizontal Mounting)

Selection conditions

Mounting: Horizontal
Bearing type: Slide bearing
Distance between plate and load center of gravity: 40 mm
Maximum speed: 400 mm/s
Load mass: 8 kg
Stroke: 100 stroke

Find the point of intersection for the load mass of 8 kg and 100 stroke on graph (17), based on horizontal mounting, slide bearing, the distance of 40 mm between the plate and load center of gravity, and the speed of 400 mm/s.

→ **MGPM32-100AZ** is selected.

(17) $L = 50$ mm, $V = 400$ mm/s

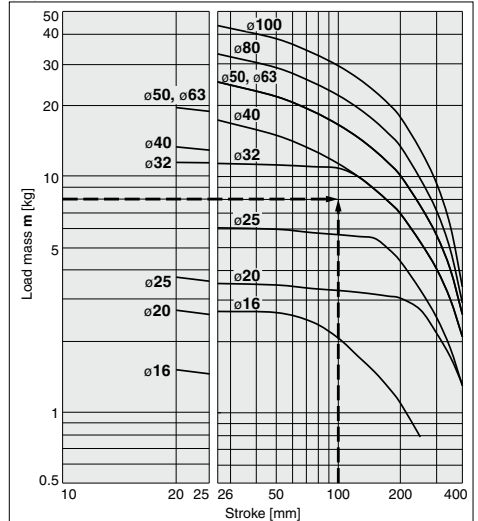

· When the maximum speed exceeds 200 mm/s, the allowable load mass is determined by multiplying the value shown in the graph at 400 mm/s by the coefficient listed in the table below.

Maximum	Up to 300 mm/s	Up to 400 mm/s	Up to 500 mm/s
Coefficient	1.7	1	0.6

· Use the Guide Cylinder Selection Software, when the eccentric distance is 200 mm or more.

Vertical Mounting Slide Bearing

— Operating pressure 0.4 MPa
 - - - - - Operating pressure 0.5 MPa or more

MGPM16 to 100

(1) 25 stroke, V = 200 mm/s or less

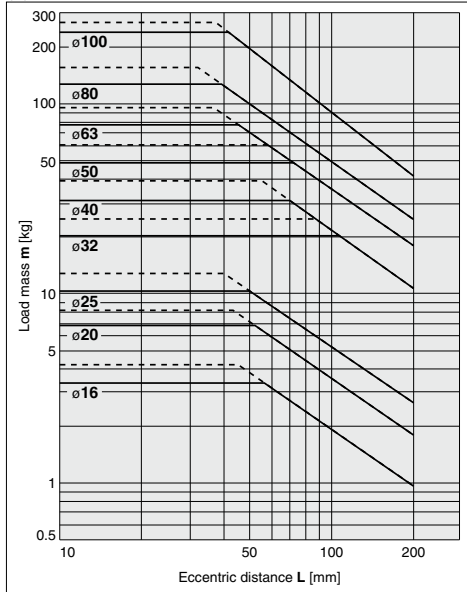

(2) Over 25 stroke, V = 200 mm/s or less

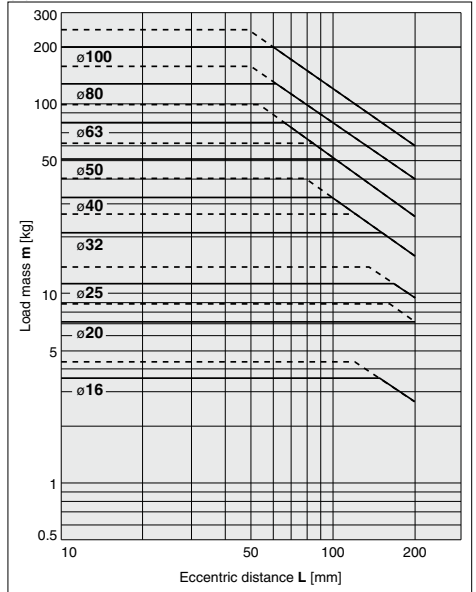

(3) 25 stroke, V = 400 mm/s

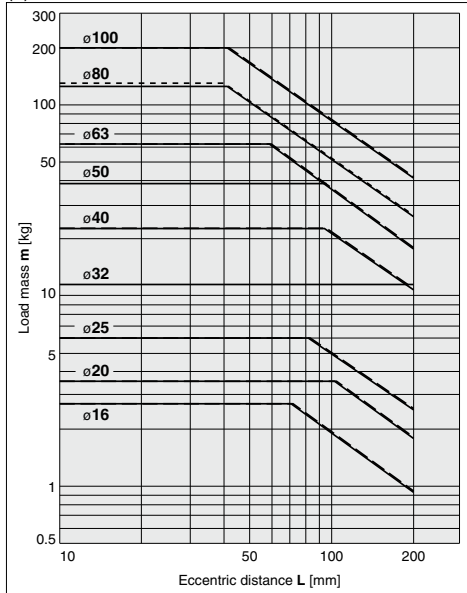

(4) Over 25 stroke, V = 400 mm/s

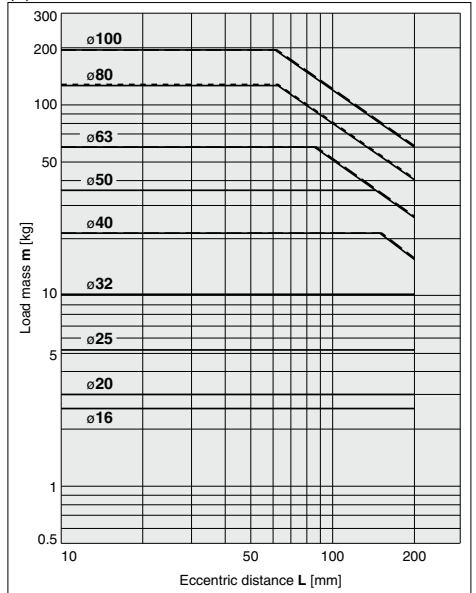

· Use the Guide Cylinder Selection Software, when the eccentric distance is 200 mm or more.

Vertical Mounting **Ball Bushing**

— Operating pressure 0.4 MPa
 - - - - - Operating pressure 0.5 MPa or more

MGPL16 to 25

(5) 75 stroke or less, $V = 200$ mm/s or less

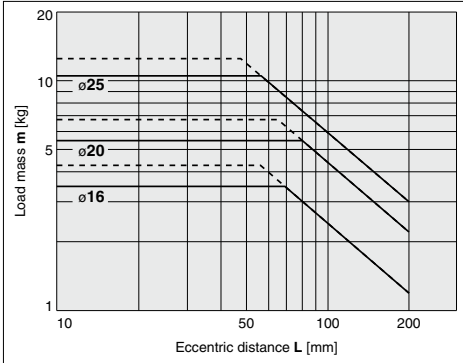

(6) Over 75 stroke, $V = 200$ mm/s or less

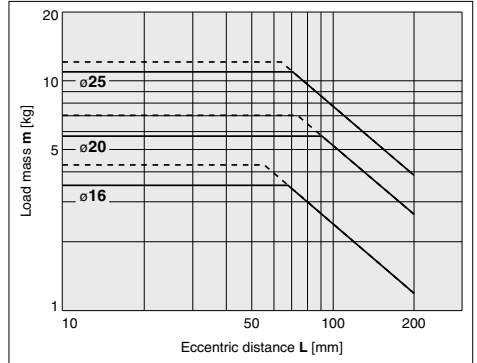

MGPL32 to 63

(7) 25 stroke, $V = 200$ mm/s or less

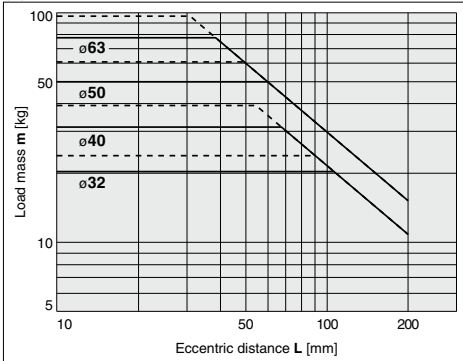

(8) Over 25 stroke, $V = 200$ mm/s or less

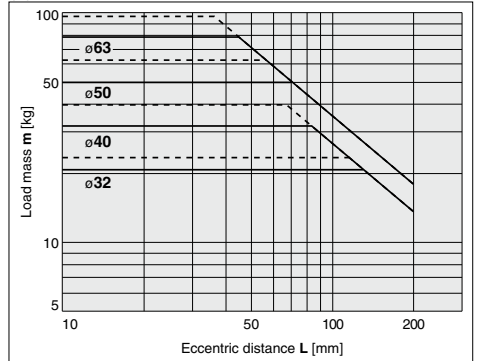

MGPL80/100

(9) $V = 200$ mm/s or less

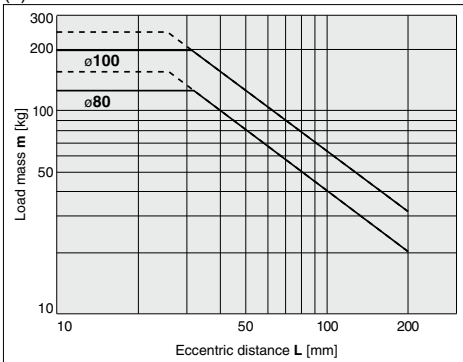

· Use the Guide Cylinder Selection Software, when the eccentric distance is 200 mm or more.

Vertical Mounting **Ball Bushing**

— Operating pressure 0.4 MPa

MGPL16 to 25

(10) 75 stroke or less, V = 400 mm/s

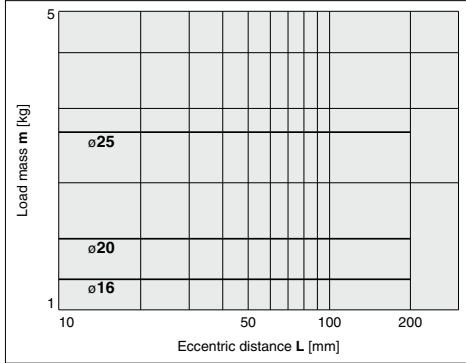

(11) Over 75 stroke, V = 400 mm/s

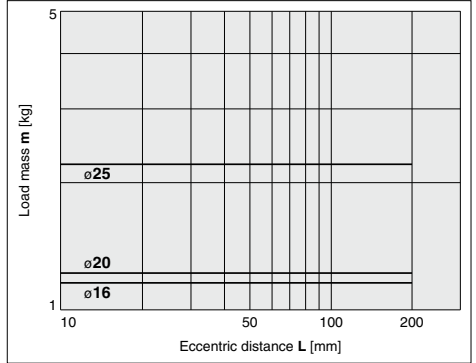

MGPL32 to 63

(12) 25 stroke, V = 400 mm/s

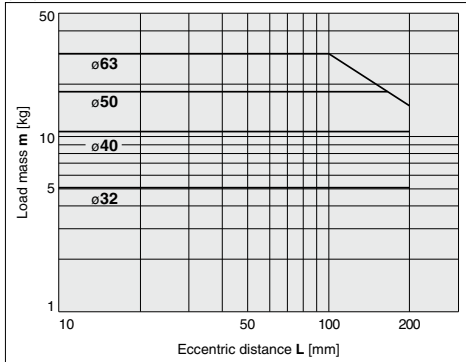

(13) Over 25 stroke, V = 400 mm/s

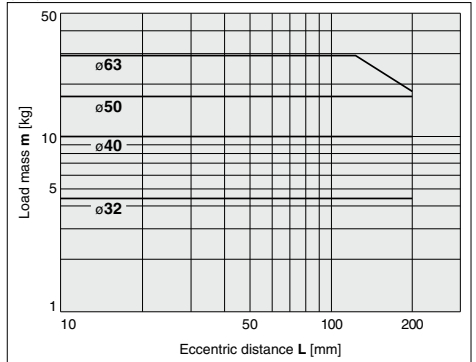

MGPL80/100

(14) V = 400 mm/s

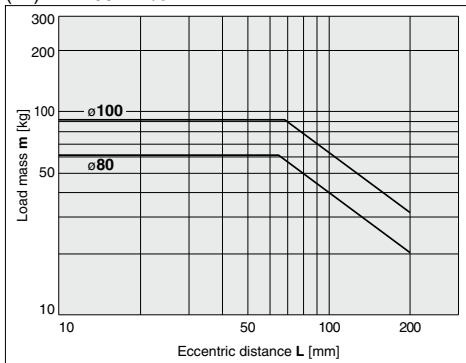

· Use the Guide Cylinder Selection Software, when the eccentric distance is 200 mm or more.

Horizontal Mounting **Slide Bearing**

MGPM16 to 100

(15) L = 50 mm, V = 200 mm/s or less

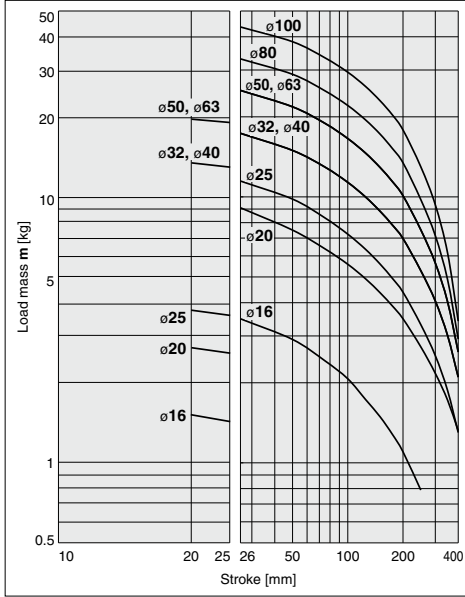

(16) L = 100 mm, V = 200 mm/s or less

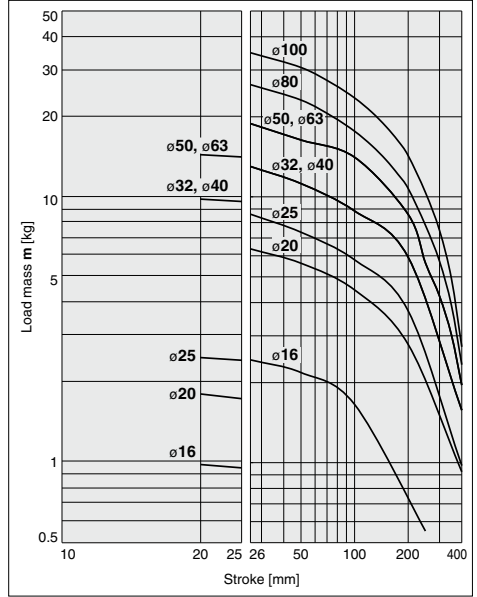

(17) L = 50 mm, V = 400 mm/s

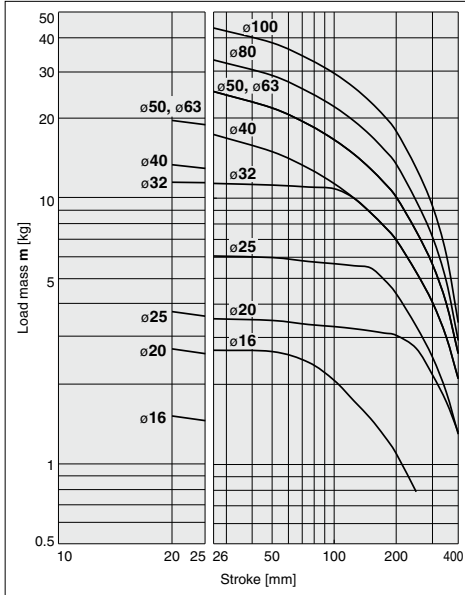

(18) L = 100 mm, V = 400 mm/s

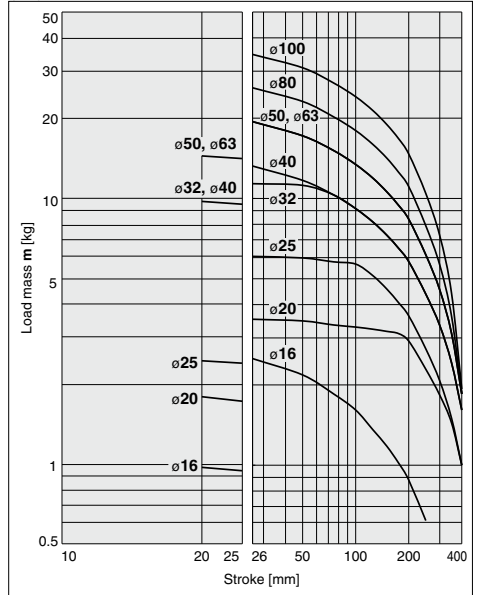

Horizontal Mounting **Ball Bushing**

(19) L = 50 mm, V = 200 mm/s or less

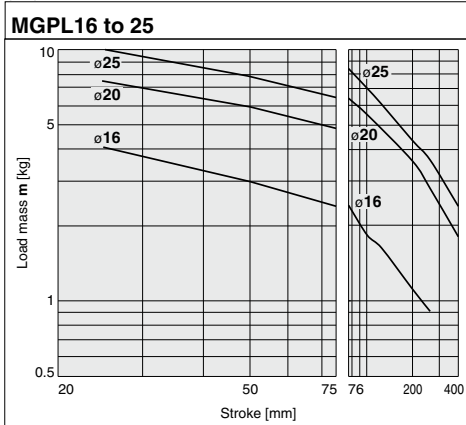

(20) L = 100 mm, V = 200 mm/s or less

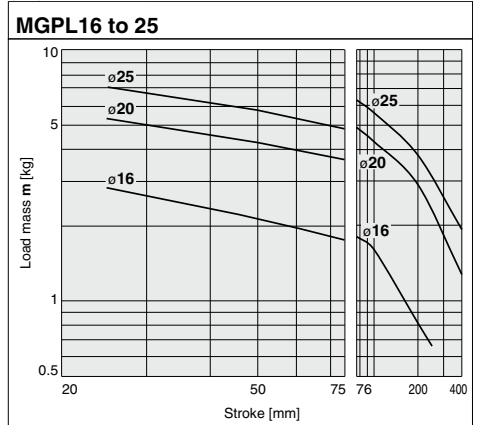

MGPL32 to 63

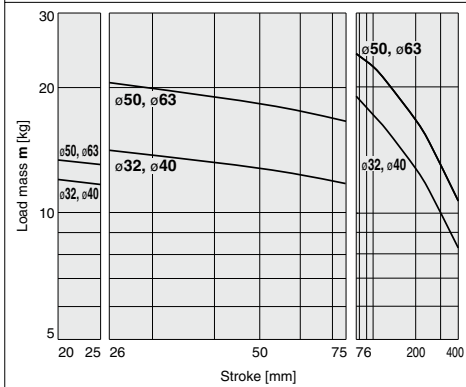

MGPL32 to 63

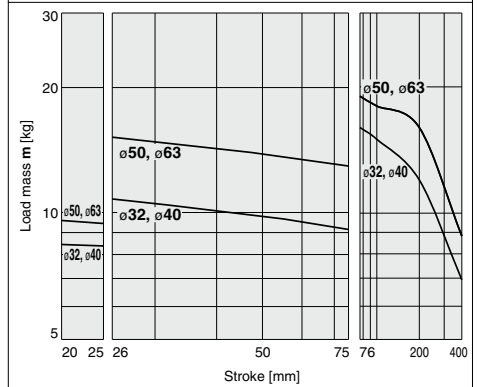

MGPL80/100

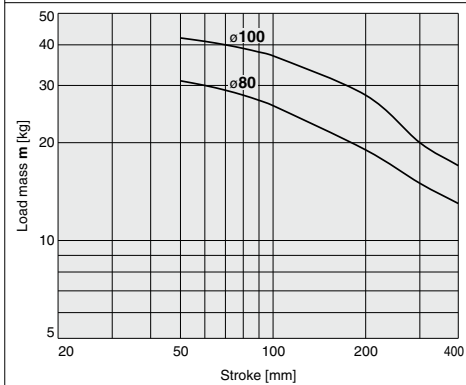

MGPL80/100

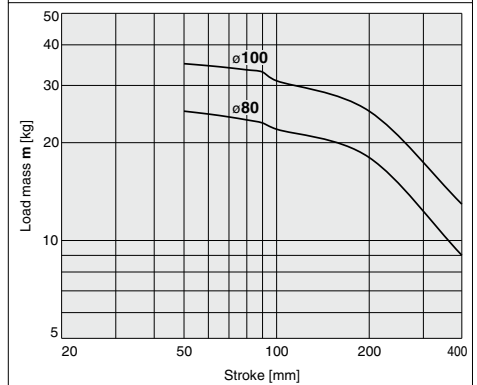

Horizontal Mounting **Ball Bushing**

(21) L = 50 mm, V = 400 mm/s

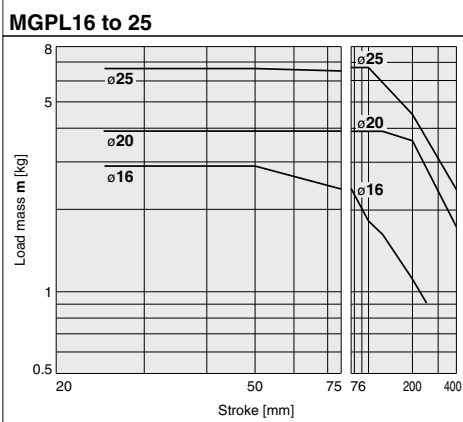

MGPL32 to 63

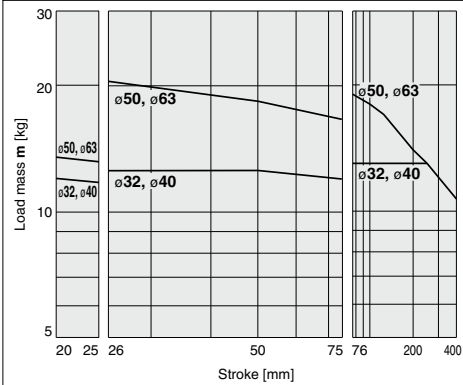

MGPL80/100

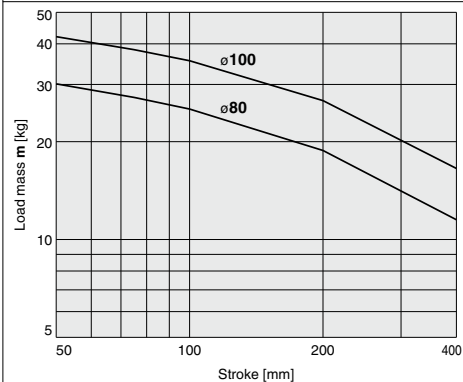

(22) L = 100 mm, V = 400 mm/s

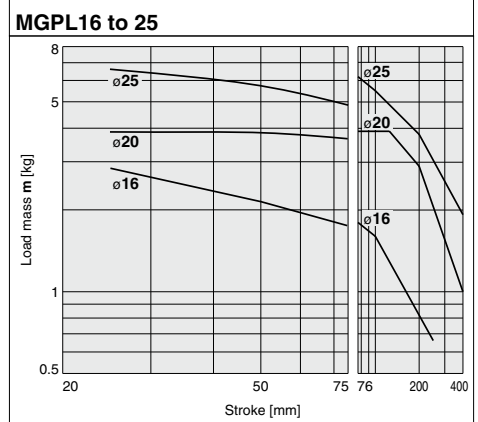

MGPL32 to 63

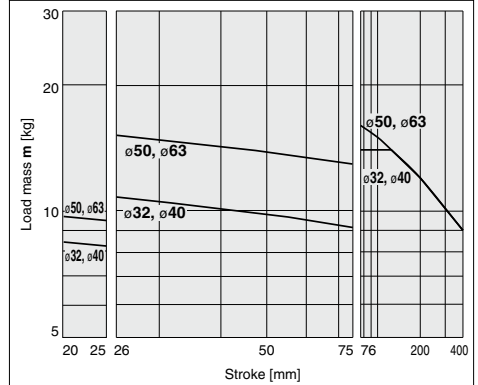

MGPL80/100

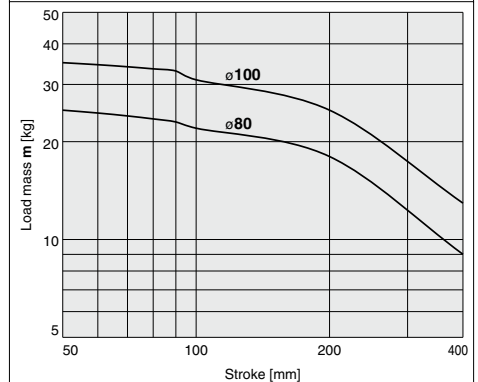

Operating Range when Used as Stopper

Bore Size $\phi 16$ to $\phi 25$ /MGPM16 to 25 (Slide Bearing)

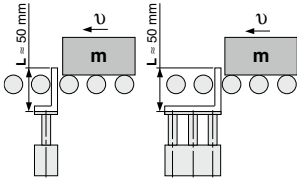

※: When selecting a model with a longer L dimension, be sure to choose a bore size which is sufficiently large.

Caution

Caution on handling

1. When using as a stopper, select a model with 25 stroke or less.
2. The MGPL (Ball bushing) and the MGPA (High precision ball bushing) cannot be used as a stopper.

MGPM16 to 25 (Slide Bearing)

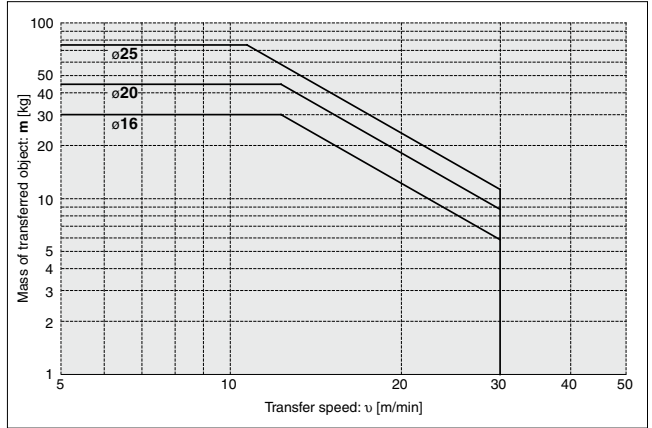

Bore Size $\phi 32$ to $\phi 100$ /MGPM32 to 100 (Slide Bearing)

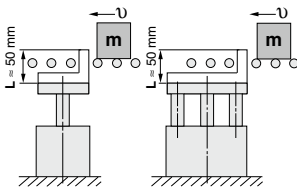

※: When selecting a model with a longer L dimension, be sure to choose a bore size which is sufficiently large.

Caution

Caution on handling

1. When using as a stopper, select a model with 50 stroke or less.
2. The MGPL (Ball bushing) and the MGPA (High precision ball bushing) cannot be used as a stopper.

MGPM32 to 100 (Slide Bearing)

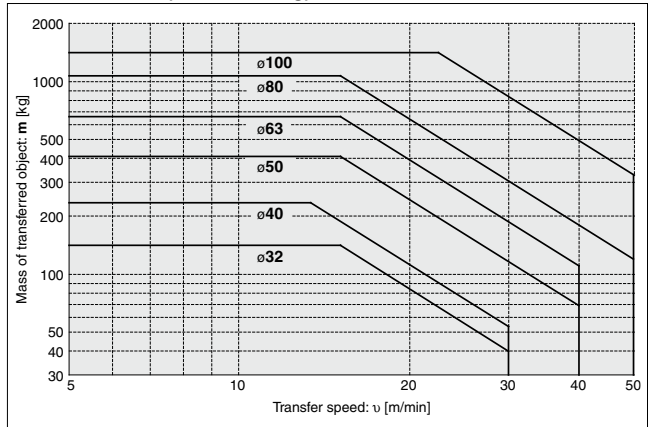

※: Refer to graphs (15) and (17) if line pressure is applied by a roller conveyor after the workpiece is stopped.

MGP Series

Construction (With Air Cushion)/MGPM Series

MGPM

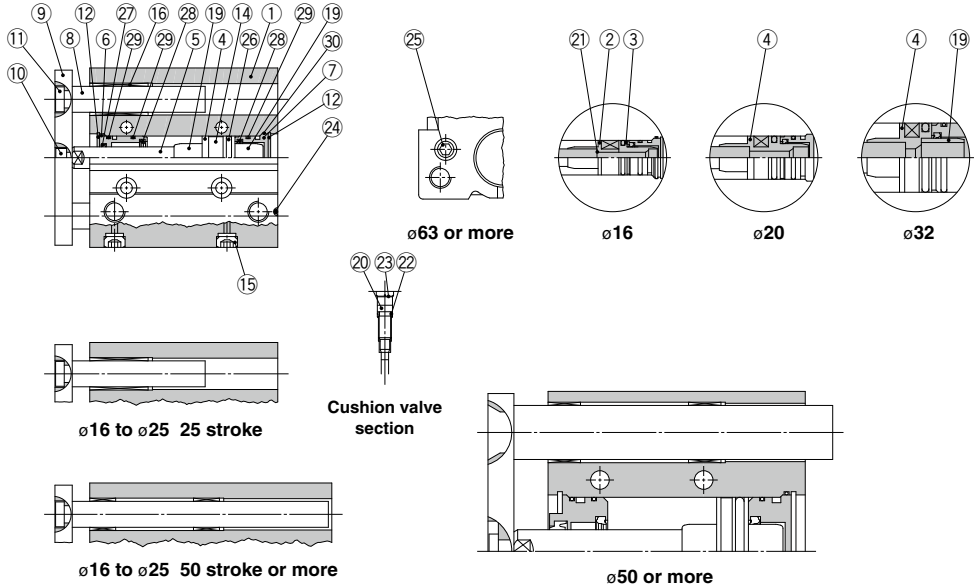

Component Parts

No.	Description	Material	Note
1	Body	Aluminum alloy	Hard anodized
2	Piston A	Aluminum alloy	ø16
3	Piston B	Aluminum alloy	ø16
4	Piston	Aluminum alloy	ø20 to ø100
5	Piston rod	Stainless steel	ø16 to ø25
		Carbon steel	ø32 to ø100 Hard chrome plating
6	Collar	Aluminum alloy	Chromated
7	Head cover	Aluminum alloy	Chromated
8	Guide rod	Carbon steel	Hard chrome plating
9	Plate	Carbon steel	Nickel plating
10	Plate mounting bolt	Carbon steel	Nickel plating
11	Guide bolt	Carbon steel	Nickel plating
12	Retaining ring	Carbon tool steel	Phosphate coated
13	Retaining ring	Carbon tool steel	Phosphate coated
14	Magnet	—	
15	Plug Hexagon socket head plug	Carbon steel	ø16 Nickel plating
			ø20 to ø100
16	Slide bearing	Bearing alloy	
17	Ball bushing	—	
18	Spacer	Aluminum alloy	
19	Cushion ring	Aluminum alloy	ø25 to ø100 Anodized
			ø16 to ø32 Electroless nickel plating
20	Cushion valve		ø50 to ø100 Chromated
			ø40 only Electroless nickel plating

∴: A felt is not installed on the slide bearing.

Component Parts

No.	Description	Material	Note
21	Gasket	NBR	ø16
22	Gasket	NBR	
23	Retaining ring	Carbon tool steel	ø50, ø63 Phosphate coated
24	Steel ball	Carbon steel	ø16 to ø50
25	Plug	Carbon steel	ø63 to ø100 Nickel plating
26*	Piston seal	NBR	
27*	Rod seal	NBR	
28*	Cushion seal	Urethane	
29*	Gasket A	NBR	
30*	Gasket B	NBR	

Replacement Parts/Seal Kit

Bore size [mm]	Kit no.	Contents	Bore size [mm]	Kit no.	Contents
16	MGP16-AZ-PS	Set of nos. above 26, 27, 28, 29, 30	50	MGP50-AZ-PS	Set of nos. above 26, 27, 28, 29, 30
20	MGP20-AZ-PS		63	MGP63-AZ-PS	
25	MGP25-AZ-PS		80	MGP80-AZ-PS	
32	MGP32-AZ-PS		100	MGP100-AZ-PS	
40	MGP40-AZ-PS				

*: Seal kit includes 26 to 30. Order the seal kit, based on each bore size.

*: Since the seal kit does not include a grease pack, order it separately.

Grease pack part no.: GR-S-010 (10 g)

Construction (With Air Cushion)/MGPL Series

MGPL

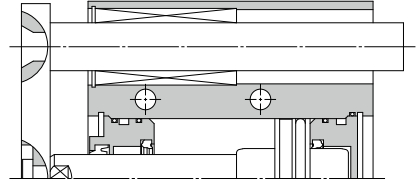
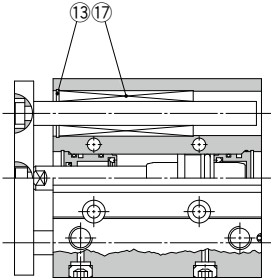

ø50 or more

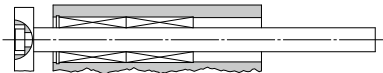

ø16 75 stroke or less



ø20 to ø63 75 stroke or less

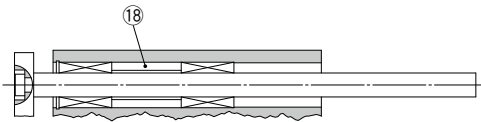

**ø16 to ø63 100 stroke or more
ø80, ø100 250 stroke or more**

MGP Series

ø16 to ø25/MGPM, MGPL, MGPA (With Air Cushion)

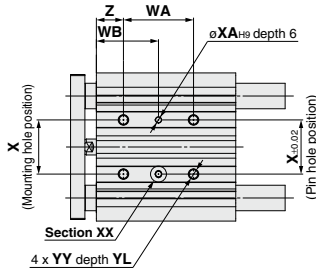

Bottom view

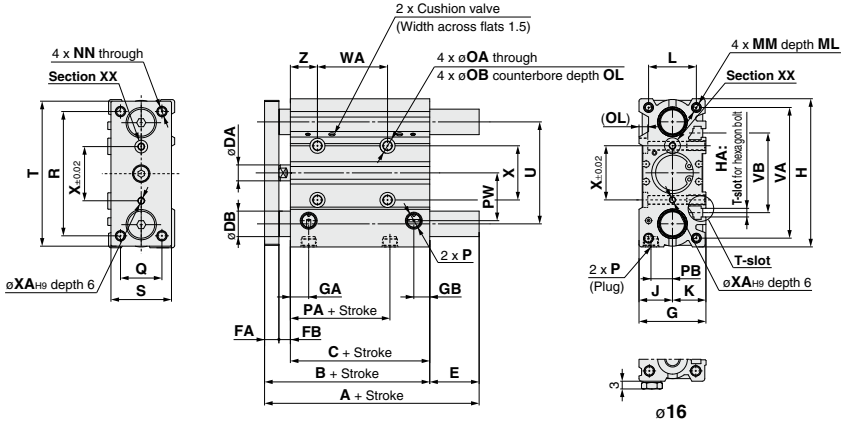
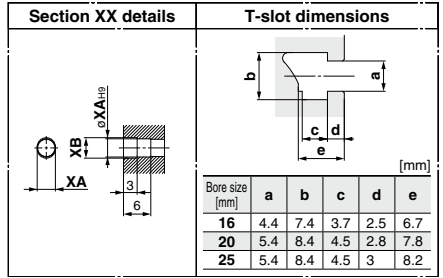

*: The use of a slot (width XA, length XB, depth 3) allows for a relaxed pin pitch tolerance, with the pin hole (øXA-H9, depth 6) as the reference, without affecting mounting accuracy.

*: For intermediate strokes other than standard strokes, refer to Manufacture of Intermediate Strokes on page 559.

*: For bore size ø16, only M5 x 0.8 port is available.

*: For bore size ø20 or more, choice of Rc, NPT, G port is available. (Refer to page 558.)

MGPM, MGPL Common Dimensions

Bore size [mm]	Standard stroke [mm]																P						
	B	C	DA	FA	FB	G	GA	GB	H	HA	J	K	L	MM	ML	NN	OA	OB	OL	Nil	TN	TF	
16	25, 50, 75, 100, 125, 150, 175, 200, 250	71	58	8	7	6	30	10.5	7.5	64	M4	15	15	22	M5 x 0.8	12	M5 x 0.8	4.3	8	4.5	—	—	
20	25, 50, 75, 100, 125, 150, 175	78	62	10	8	8	36	11.5	9	83	M5	18	18	24	M5 x 0.8	13	M5 x 0.8	5.4	9.5	5.5	Rc1/8	NPT1/8	G1/8
25	200, 250, 300, 350, 400	78.5	62.5	10	9	7	42	11.5	10	93	M5	21	21	30	M6 x 1.0	15	M6 x 1.0	5.4	9.5	5.5	Rc1/8	NPT1/8	G1/8

Bore size [mm]	WA											WB												
	PA	PB	PW	Q	R	S	T	U	VA	VB	Z	75 st or less	100 to 175 st	200, 250 st	300 st or more	75 st or less	100 to 175 st	200, 250 st	300 st or more	X	XA	XB	YY	YL
16	39.5	10	19	16	54	25	62	46	56	38	44	110	200	—	27	60	105	—	24	3	3.5	M5 x 0.8	10	5
20	38.5	10.5	25	18	70	30	81	54	72	44	44	120	200	300	39	77	117	167	28	3	3.5	M6 x 1.0	12	17
25	37.5	13.5	30	26	78	38	91	64	82	50	44	120	200	300	39	77	117	167	34	4	4.5	M6 x 1.0	12	17

MGPM (Slide bearing)/A, DB, E Dimensions

Bore size [mm]	A			DB	E		
	25 to 100 st	125 to 200 st	250 st or more		25 to 100 st	125 to 200 st	250 st or more
16	71	92.5	92.5	10	0	21.5	21.5
20	78	78	110	12	0	0	32
25	78.5	78.5	109.5	16	0	0	31

MGPL (Ball bushing)

MGPA (High precision ball bushing)/A, DB, E Dimensions

Bore size [mm]	A			DB	E		
	25 to 75 st	100 to 200 st	250 st or more		25 to 75 st	100 to 200 st	250 st or more
16	71	94.5	94.5	8	0	23.5	23.5
20	78	100	117.5	10	0	22	39.5
25	81.5	100.5	117.5	13	3	22	39

ø32 to ø63/MGPM, MGPL, MGPA (With Air Cushion)

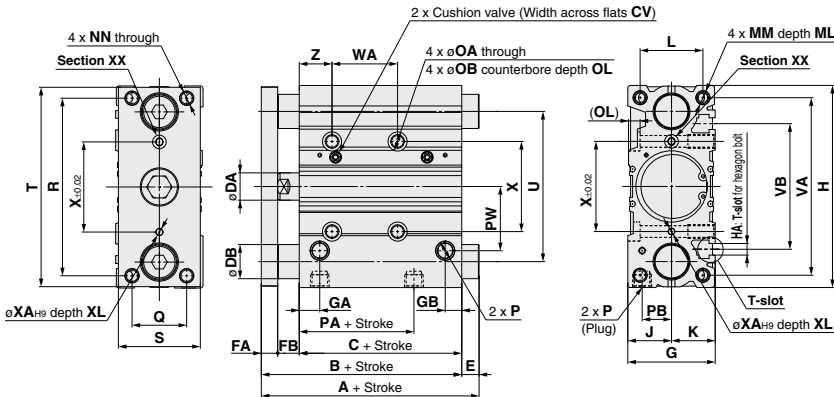
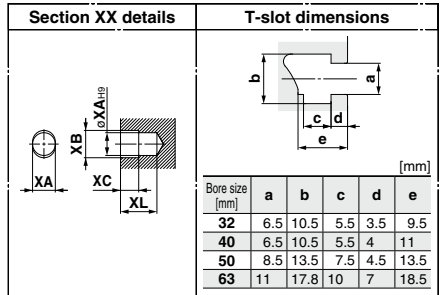
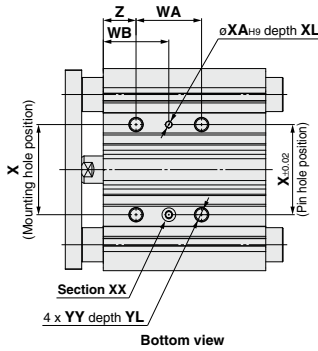

- *: The use of a slot (width XA, length XB, depth XC) allows for a relaxed pin pitch tolerance, with the pin hole (ϕXA_{H9} , depth XL) as the reference, without affecting mounting accuracy.
- *: For intermediate strokes other than standard strokes, refer to Manufacture of Intermediate Strokes on page 559.
- *: Choice of Rc, NPT, G port is available. (Refer to page 558).

MGPM, MGPL Common Dimensions

Bore size [mm]	Standard stroke [mm]	B	C	CV	DA	FA	FB	G	GA	GB	H	HA	J	K	L	MM	ML	NN	OA	OB	OL	P		
																						Nil	TN	TF
32	25, 50, 75, 100	84.5	62.5	1.5	14	10	12	48	12	9	112	M6	24	24	34	M8 x 1.25	20	M8 x 1.25	6.7	11	7.5	Rc1/8	NPT1/8	G1/8
40	125, 150, 175	91	69	1.5	14	10	12	54	15	12	120	M6	27	27	40	M8 x 1.25	20	M8 x 1.25	6.7	11	7.5	Rc1/8	NPT1/8	G1/8
50	200, 250, 300	97	69	3	20	12	16	64	15	12	148	M8	32	32	46	M10 x 1.5	22	M10 x 1.5	8.6	14	9	Rc1/4	NPT1/4	G1/4
63	350, 400	102	74	3	20	12	16	78	15.5	13.5	162	M10	39	39	58	M10 x 1.5	22	M10 x 1.5	8.6	—	9	Rc1/4	NPT1/4	G1/4

Bore size [mm]	PA	PB	PW	Q	R	S	T	U	VA	VB	WA			WB			X	XA	XB	XC	XL	YY	YL	Z		
											75 st or less	100 to 175 st	200, 250 st	300 st or more	75 st or less	100 to 175 st									200, 250 st	300 st or more
32	31.5	16	35.5	30	96	44	110	78	98	63	48	124	200	300	45	83	121	171	42	4	4.5	3	6	M8 x 1.25	16	21
40	38	18	39.5	30	104	44	118	86	106	72	48	124	200	300	46	84	122	172	50	4	4.5	3	6	M8 x 1.25	16	22
50	34	21.5	47	40	130	60	146	110	130	92	48	124	200	300	48	86	124	174	66	5	6	4	8	M10 x 1.5	20	24
63	38	28	58	50	130	70	158	124	142	110	52	128	200	300	50	88	124	174	80	5	6	4	8	M10 x 1.5	20	24

MGPL (Ball bushing)

MGPA (High precision ball bushing)/A, DB, E Dimensions [mm]

MGPM (Slide bearing)/A, DB, E Dimensions [mm]

Bore size [mm]	A				DB	E		
	25 st	50 to 200 st	250 st or more	250 st or more		25 st	50 to 200 st	250 st or more
32	84.5	93.5	129.5	20	0	9	45	
40	91	93.5	129.5	20	0	2.5	38.5	
50	97	109.5	150.5	25	0	12.5	53.5	
63	102	109.5	150.5	25	0	7.5	48.5	

Bore size [mm]	A				DB	E			
	25 st	50, 75 st	100 to 200 st	250 st or more		25 st	50, 75 st	100 to 200 st	250 st or more
32	84.5	96.5	116.5	138.5	16	0	12	32	54
40	91	96.5	116.5	138.5	16	0	5.5	25.5	47.5
50	97	112.5	132.5	159.5	20	0	15.5	35.5	62.5
63	102	112.5	132.5	159.5	20	0	10.5	30.5	57.5

∅80, ∅100/MGPM, MGPL, MGPA (With Air Cushion)

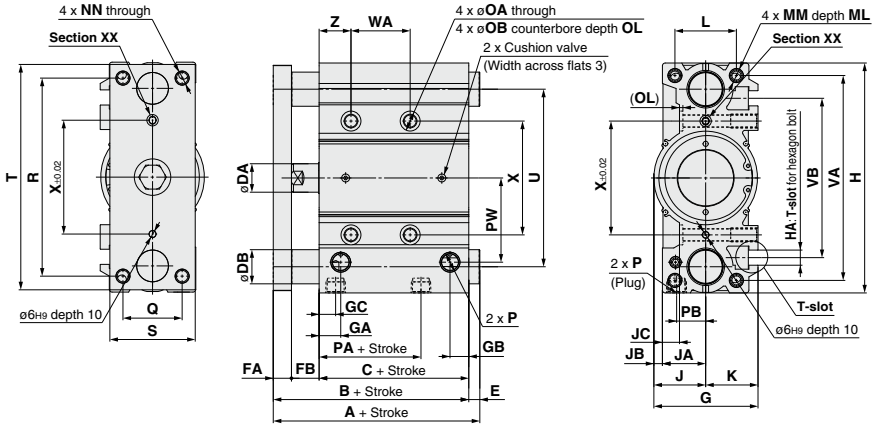
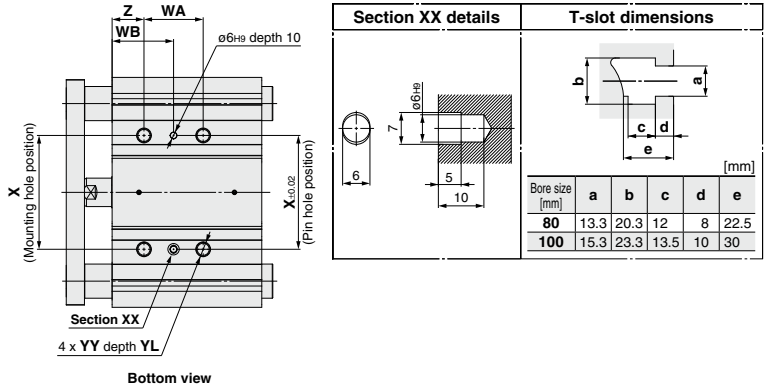

*: The use of a slot (width X6, length 7, depth 5) allows for a relaxed pin pitch tolerance, with the pin hole (∅6H9, depth 10) as the reference, without affecting mounting accuracy.

*: For intermediate strokes other than standard strokes, refer to Manufacture of Intermediate Strokes on page 559.

*: Choice of Rc, NPT, G port is available. (Refer to page 558.)

MGPM, MGPL Common Dimensions

Bore size [mm]	Standard stroke [mm]	B	C	DA	FA	FB	G	GA	GB	GC	H	HA	J	JA	JB	JC	K	L	MM	ML	NN	OA	OB	OL	P		
																									Nil	TN	TF
80	50, 75, 100, 125, 150, 175	121.5	81.5	25	16	24	91.5	19	16.5	14.5	202	M12	45.5	38	7.5	15	46	54	M12 x 1.75	25	M12 x 1.75	10.6	17.5	3	Rc3/8	NPT3/8	G3/8
100	200, 250, 300, 350, 400	141	91	30	19	31	111.5	22.5	20.5	18	240	M14	55.5	45	10.5	10	56	62	M14 x 2.0	31	M14 x 2.0	12.5	20	8	Rc3/8	NPT3/8	G3/8

Bore size [mm]	PA	PB	PW	Q	R	S	T	U	VA	VB	WA			WB			X	YY	YL	Z		
											50, 75 st	100 to 175 st	200, 250 st	300 st or more	50, 75 st	100 to 175 st					200, 250 st	300 st or more
80	39.5	25.5	74	52	174	75	198	156	180	140	52	128	200	300	54	92	128	178	100	M12 x 1.75	24	28
100	42.5	32.5	89	64	210	90	236	188	210	166	72	148	220	320	47	85	121	171	124	M14 x 2.0	28	11

MGPL (Ball bushing)

MGPM (Slide bearing)/A, DB, E Dimensions

Bore size [mm]	A		DB	E	
	50 to 200 st	250 st or more		50 to 200 st	250 st or more
80	131.5	180.5	30	10	59
100	151.5	190.5	36	10.5	49.5

MGPA (High precision ball bushing)/A, DB, E Dimensions

Bore size [mm]	A		DB	E	
	50 to 200 st	250 st or more		50 to 200 st	250 st or more
80	158.5	191.5	25	37	70
100	178.5	201.5	30	37.5	60.5

Compact Guide Cylinder/With End Lock

MGP Series

∅20, ∅25, ∅32, ∅40, ∅50, ∅63, ∅80, ∅100

How to Order

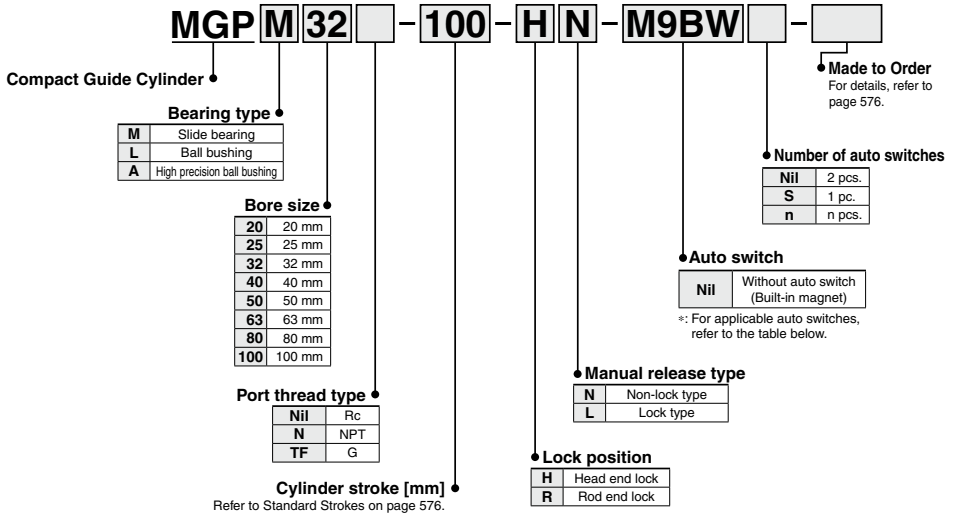

Applicable Auto Switches/Refer to pages 1289 to 1383 for further information on auto switches.

Type	Special function	Electrical entry	Indicating light	Wiring (Output)	Load voltage		Auto switch model		Lead wire length [m]			Pre-wired connector	Applicable load		
					DC	AC	Perpendicular	In-line	0.5 (Nil)	1 (M)	3 (L)		5 (Z)	IC circuit	Relay, PLC
Solid state auto switch	—	Grommet	Yes	3-wire (NPN)	5 V, 12 V	—	M9NV	M9N	●	●	●	○	IC circuit	Relay, PLC	
				3-wire (PNP)			M9PV	M9P	●	●	●	○			
	2-wire			M9BV	M9B		●	●	●	○	—				
	3-wire (NPN)			M9NWV	M9NW		●	●	●	○	IC circuit				
	3-wire (PNP)			M9PWW	M9PW		●	●	●	○	—				
	2-wire			M9BWW	M9BW		●	●	●	○	—				
	3-wire (NPN)			M9NAV ^{*1}	M9NA ^{*1}		○	○	●	○	IC circuit				
	3-wire (PNP)			M9PAV ^{*1}	M9PA ^{*1}		○	○	●	○	—				
	2-wire			M9BAV ^{*1}	M9BA ^{*1}		○	○	●	○	—				
	2-wire (Non-polar)			—	P3DWA		●	—	●	○	—				
Reed auto switch	—	Grommet	Yes	3-wire (NPN equivalent)	—	5 V	A96V	A96	●	—	●	—	IC circuit	—	
				2-wire			100 V	A93V ^{*2}	A93	●	●	●	—	—	Relay, PLC
				2-wire			100 V or less	A90V	A90	●	—	●	—	—	IC circuit

*1: Water resistant type auto switches can be mounted on the above models, but in such case SMC cannot guarantee water resistance.

Please consult with SMC regarding water resistant types with the above model numbers.

*2: 1 m type lead wire is only applicable to the D-A93.

*: Lead wire length symbols: 0.5 m..... Nil (Example) M9NW
 1 m..... M (Example) M9NWM
 3 m..... L (Example) M9NWL
 5 m..... Z (Example) M9NWZ

*: Solid state auto switches marked with "○" are produced upon receipt of order.

*: Bore sizes 32 to 100 are available for D-P4DW□.

*: Bore sizes 25 to 100 are available for D-P3DWA□.

*: Since there are other applicable auto switches than listed above, refer to page 595 for details.

*: For details about auto switches with pre-wired connector, refer to pages 1358 and 1359.

*: Auto switches are shipped together, (but not assembled).

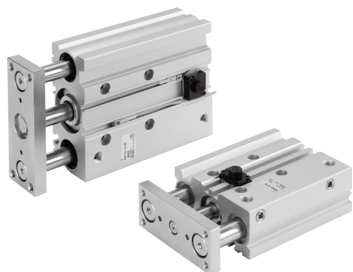

Symbol

Rubber bumper

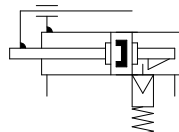

Made to Order: Individual Specifications
(For details, refer to pages 597 and 598.)

Symbol	Specifications
-X867	Side porting type (Plug location changed) *1

*1: The shape is the same as the current product.



Made to Order
[Click here for details](#)

Symbol	Specifications
-XB13	Low speed cylinder (5 to 50 mm/s)
-XC79	Tapped hole, drilled hole, pinned hole machined additionally *1
-XC85	Grease for food processing equipment

*1: The shape is the same as the current product.

Refer to pages 592 to 596 for cylinders with auto switches.

- Minimum stroke for auto switch mounting
- Auto switch proper mounting position (detection at stroke end) and its mounting height
- Operating range
- Auto switch mounting brackets/Part no.
- Auto switch mounting

Specifications

Bore size [mm]	20	25	32	40	50	63	80	100
Action	Double acting							
Fluid	Air							
Proof pressure	1.5 MPa							
Maximum operating pressure	1.0 MPa							
Minimum operating pressure	0.15 MPa *1							
Ambient and fluid temperature	-10 to 60°C (No freezing)							
Piston speed *2	50 to 500 mm/s						50 to 400 mm/s	
Cushion	Rubber bumper on both ends							
Lubrication	Not required (Non-lube)							
Stroke length tolerance	± 1.5 mm							

*1: 0.1 MPa except the lock unit.

*2: Maximum speed with no load. Depending on the operating conditions, the piston speed may not be satisfied. Make a model selection, considering a load according to the graph on pages 545 to 551.

Lock Specifications

Lock position	Head end, Rod end							
Holding force (Max.) N	ø20	ø25	ø32	ø40	ø50	ø63	ø80	ø100
	215	330	550	860	1340	2140	3450	5390
Backlash	2 mm or less							
Manual release	Non-lock type, Lock type							

Adjust switch positions for operation at both the stroke end and backlash (2 mm) movement positions.

Standard Strokes

Bore size [mm]	Standard stroke [mm]
20, 25, 32, 40, 50, 63, 80, 100	25, 50, 75, 100, 125, 150, 175, 200, 250, 300, 350, 400

Manufacture of Intermediate Stroke

Description	Spacer installation type. Dealing with the stroke in 5 mm increments is available by installing spacer with standard stroke cylinder. When a spacer is mounted on the cylinder with an end lock on the rod side, use a special piston rod.
Part no.	Refer to "How to Order" for the standard model numbers on page 575.
Applicable stroke [mm]	5 to 395
Example	Part no.: MGPM50-35-HN A spacer 15 mm in width is installed in a MGPM50-50-HN. C dimension is 119 mm.

*: The minimum stroke for mounting auto switches is 10 stroke or more for two switches, and 5 stroke or more for one switch.

*: Intermediate stroke (in 1 mm increments) based on an exclusive body will be available upon request for special.

Theoretical Output



Bore size [mm]	Rod size [mm]	Operating direction	Piston area [mm ²]	Operating pressure [MPa]									
				0.2	0.3	0.4	0.5	0.6	0.7	0.8	0.9	1.0	
20	10	OUT	314	63	94	126	157	188	220	251	283	314	
		IN	236	47	71	94	118	142	165	189	212	236	
25	12	OUT	491	98	147	196	246	295	344	393	442	491	
		IN	378	76	113	151	189	227	265	302	340	378	
32	16	OUT	804	161	241	322	402	482	563	643	724	804	
		IN	603	121	181	241	302	362	422	482	543	603	
40	16	OUT	1257	251	377	503	629	754	880	1006	1131	1257	
		IN	1056	211	317	422	528	634	739	845	950	1056	
50	20	OUT	1963	393	589	785	982	1178	1374	1570	1767	1963	
		IN	1649	330	495	660	825	990	1154	1319	1484	1649	
63	20	OUT	3117	623	935	1247	1559	1870	2182	2494	2805	3117	
		IN	2803	561	841	1121	1402	1682	1962	2242	2523	2803	
80	25	OUT	5027	1005	1508	2011	2514	3016	3519	4022	4524	5027	
		IN	4536	907	1361	1814	2268	2722	3175	3629	4082	4536	
100	30	OUT	7854	1571	2356	3142	3927	4712	5498	6283	7069	7854	
		IN	7147	1429	2144	2859	3574	4288	5003	5718	6432	7147	

*: Theoretical output [N] = Pressure [MPa] x Piston area [mm²]

Weights

Slide Bearing: MGPM20 to 100 (Basic weight)

Bore size [mm]	Standard stroke [mm]											
	25	50	75	100	125	150	175	200	250	300	350	400
20	0.86	1.12	1.32	1.52	1.71	1.91	2.11	2.31	2.78	3.18	3.57	3.97
25	1.18	1.56	1.83	2.10	2.38	2.65	2.92	3.19	3.85	4.39	4.94	5.48
32	1.92	2.32	2.70	3.09	3.47	3.85	4.23	4.61	5.56	6.32	7.09	7.85
40	2.20	2.66	3.08	3.51	3.93	4.36	4.78	5.20	6.24	7.10	7.95	8.80
50	3.73	4.46	5.10	5.74	6.38	7.02	7.66	8.30	9.91	11.2	12.5	13.8
63	4.61	5.45	6.21	6.96	7.72	8.47	9.23	9.99	11.8	13.3	14.8	16.3
80	7.88	8.70	9.49	10.3	11.2	12.0	12.8	13.9	15.5	17.2	18.8	20.5
100	12.1	13.2	14.4	15.6	16.8	18.0	19.1	20.6	22.9	25.3	27.6	30.0

Ball Bushing, High Precision Ball Bushing: MGPA20 to 100 (Basic weight)

Bore size [mm]	Standard stroke [mm]											
	25	50	75	100	125	150	175	200	250	300	350	400
20	0.93	1.10	1.27	1.48	1.65	1.83	2.00	2.17	2.55	2.90	3.25	3.60
25	1.27	1.50	1.74	2.01	2.24	2.47	2.70	2.94	3.44	3.91	4.37	4.83
32	1.74	2.19	2.51	2.88	3.20	3.51	3.83	4.15	4.84	5.47	6.10	6.73
40	2.02	2.51	2.87	3.29	3.65	4.01	4.37	4.73	5.51	6.23	6.95	7.67
50	3.46	4.21	4.76	5.40	5.95	6.50	7.05	7.60	8.83	9.92	11.1	12.2
63	4.33	5.20	5.86	6.62	7.28	7.95	8.61	9.27	10.7	12.1	13.4	14.7
80	8.05	8.87	9.66	10.5	11.4	12.2	13.0	14.1	15.7	17.4	19.0	20.7
100	12.4	13.5	14.7	15.9	17.1	18.3	19.4	20.9	23.2	25.6	27.9	30.3

Lock Unit Additional Weight

Bore size [mm]	Head end lock		Rod end lock	
	HN	HL	RN	RL
20	0.05	0.07	0.05	0.06
25	0.06	0.07	0.05	0.07
32	0.09	0.10	0.09	0.10
40	0.15	0.18	0.14	0.18
50	0.24	0.27	0.23	0.27

Bore size [mm]	Head end lock		Rod end lock	
	HN	HL	RN	RL
63	0.36	0.40	0.35	0.39
80	0.90	0.97	1.03	1.10
100	1.52	1.60	1.60	1.68

Calculation: (Example) **MGPM50-100-HN**
 • Basic Weight + Lock unit additional weight
 • 5.74 + 0.24 = 5.98 kg

Allowable Rotational Torque of Plate

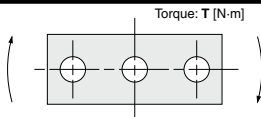

Bore size [mm]	Bearing type	Stroke [mm]											
		25	50	75	100	125	150	175	200	250	300	350	400
20	MGPM	0.99	0.75	1.88	1.63	1.44	1.28	1.16	1.06	0.90	0.78	0.69	0.62
	MGPL/A	2.66	1.94	1.52	1.25	1.34	1.17	1.03	0.93	0.76	0.65	0.56	0.49
25	MGPM	1.64	1.25	2.96	2.57	2.26	2.02	1.83	1.67	1.42	1.24	1.09	0.98
	MGPL/A	4.08	3.02	2.38	1.97	2.05	1.78	1.58	1.41	1.16	0.98	0.85	0.74
32	MGPM	6.35	5.13	5.69	4.97	4.42	3.98	3.61	3.31	2.84	2.48	2.20	1.98
	MGPL/A	5.95	4.89	5.11	4.51	6.34	5.79	5.33	4.93	4.29	3.78	3.38	3.04
40	MGPM	7.00	5.66	6.27	5.48	4.87	4.38	5.98	3.65	3.13	2.74	2.43	2.19
	MGPL/A	6.55	5.39	5.62	4.96	6.98	6.38	5.87	5.43	4.72	4.16	3.71	3.35
50	MGPM	13.0	10.8	12.0	10.6	9.50	8.60	7.86	7.24	6.24	5.49	4.90	4.43
	MGPL/A	9.17	7.62	9.83	8.74	11.6	10.7	9.83	9.12	7.95	7.02	6.26	5.63
63	MGPM	14.7	12.1	13.5	11.9	10.7	9.69	8.86	8.16	7.04	6.19	5.52	4.99
	MGPL/A	10.2	8.48	11.0	9.74	13.0	11.9	11.0	10.2	8.84	7.80	6.94	6.24
80	MGPM	21.9	18.6	22.9	20.5	18.6	17.0	15.6	14.5	12.6	11.2	10.0	9.11
	MGPL/A	15.1	23.3	22.7	20.6	18.9	17.3	16.0	14.8	12.9	11.3	10.0	8.94
100	MGPM	38.8	33.5	37.5	33.8	30.9	28.4	26.2	24.4	21.4	19.1	17.2	15.7
	MGPL/A	27.1	30.6	37.9	34.6	31.8	29.3	27.2	25.3	22.1	19.5	17.3	15.5

Non-rotating Accuracy of Plate

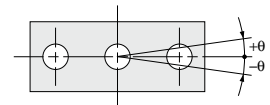

For non-rotating accuracy θ without load, use a value no more than the values in the table as a guide.

Bore size [mm]	Non-rotating accuracy θ		
	MGPM	MGPL	MGPA
20			
25	$\pm 0.07^\circ$	$\pm 0.09^\circ$	
32			
40	$\pm 0.06^\circ$	$\pm 0.08^\circ$	
50			
63	$\pm 0.05^\circ$	$\pm 0.06^\circ$	
80			
100	$\pm 0.04^\circ$	$\pm 0.05^\circ$	

Model selection

Model selection is the same as MGP/standard type.

Refer to pages 545 to 552.

MGP Series

Construction/MGPM Series

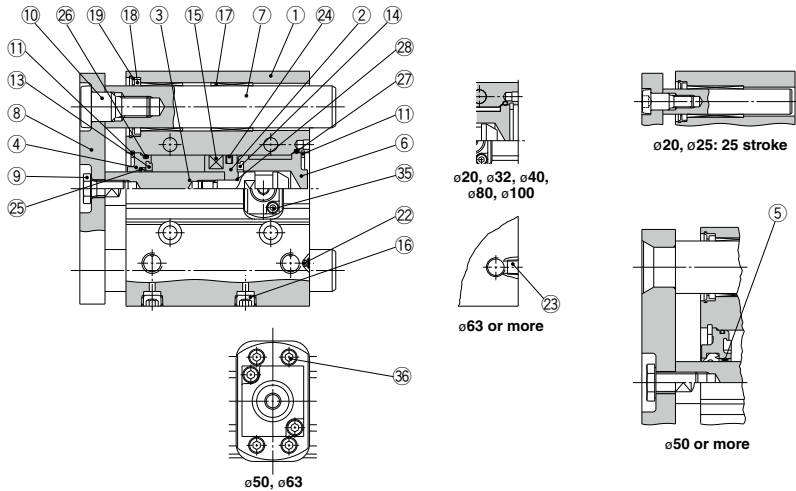

Non-locking type

(Head end lock)

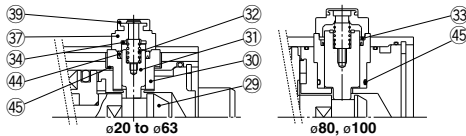

(Rod end lock)

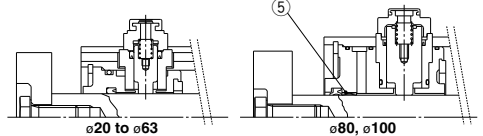

Component Parts

No.	Description	Material	Note
1	Body	Aluminum alloy	Hard anodized
2	Piston	Aluminum alloy	
3	Piston rod	Stainless steel ø20, ø25	Hard chrome plating with rod end lock only
		Carbon steel ø32 to ø100	
4	Collar	Aluminum alloy	Chromated
5	Bushing	Bearing alloy	
6	Head cover	Aluminum alloy	Chromated
7	Guide rod	Carbon steel	Hard chrome plating
8	Plate	Carbon steel	Nickel plating
9	Plate mounting bolt	Carbon steel	Nickel plating
10	Guide bolt	Carbon steel	Nickel plating
11	Retaining ring	Carbon tool steel	Phosphate coated
12	Retaining ring	Carbon tool steel	Phosphate coated
13	Bumper A	Urethane	
14	Bumper B	Urethane	
15	Magnet	—	
16	Hexagon socket head cap plug	Carbon steel	Nickel plating
17	Slide Bearing	Bearing alloy	
18	Felt	Felt	
19	Holder	Resin	
20	Ball bushing		
21	Spacer	Aluminum alloy	
22	Steel ball	Carbon steel	ø20 to ø50
23	Plug	Carbon steel	ø63 to ø100 Nickel plating
24*	Piston seal	NBR	
25*	Rod seal	NBR	
26*	Gasket A	NBR	
27*	Gasket B	NBR	

Component Parts

No.	Description	Material	Note
28	Piston gasket	NBR	ø32 to ø100 only
29	Lock bolt	Carbon steel	Zinc chromated
30	Lock holder	Brass	Electroless nickel plating
31	Lock piston	Carbon steel	Hard chrome plating
32	Lock spring	Stainless steel	
33	Seal retainer	Carbon steel	Zinc chromated (ø80, ø100 only)
34	Bumper	Urethane	
35†	Hexagon socket head cap screw	Carbon steel	Black zinc chromated
36†	Hexagon socket head cap screw	Carbon steel	Zinc chromated (ø50, ø63 only)
37	Cap A	Aluminum die-casted	Black painted
38	Cap B	Carbon steel	SQ treated
39	Rubber cap	Synthetic rubber	
40	M/O knob	Zinc die-casted	Black painted
41	M/O bolt	Alloy steel	Black zinc chromated
42	M/O spring	Steel wire	chromated
43	Stopper ring	Carbon steel	chromated
44†	Lock piston seal	NBR	
45†	Lock holder gasket	NBR	

Replacement Parts/Seal Kit

Bore size [mm]	Kit no.	Contents	Bore size [mm]	Kit no.	Contents
20	MGP20-B-PS	Set of nos. above	50	MGP50-B-PS	Set of nos. 24, 25, 26, 27, 28
25	MGP25-B-PS		63	MGP63-B-PS	above 35, 36, 44, 45
32	MGP32-B-PS	24, 25, 26, 27, 35, 44, 45	80	MGP80-B-PS	Set of nos. 24, 25, 26, 27, 28
40	MGP40-B-PS		100	MGP100-B-PS	above 44, 45

*: Each seal kit includes the parts listed above. Order the seal kit based on each bore size.

†: Since the seal kit does not include a grease pack, order it separately.
Grease pack part no.: GR-S-010 (10 g)

Construction/MGPL, MGPA Series

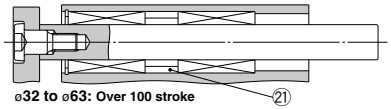
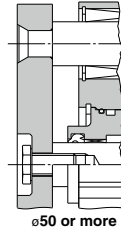
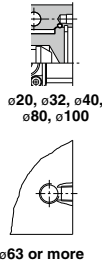
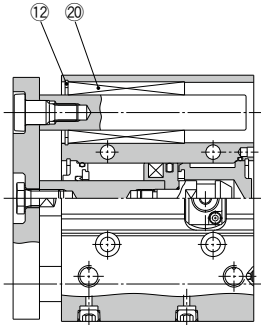

Lock type

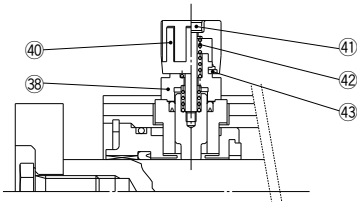

MGP Series

Dimensions: $\varnothing 20$, $\varnothing 25$

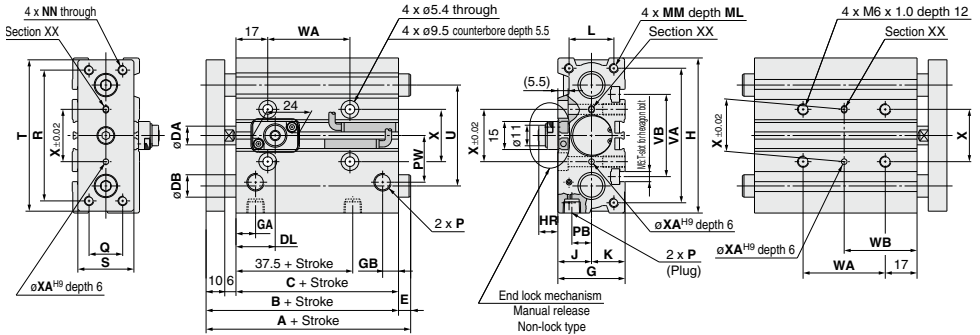

With rod end lock

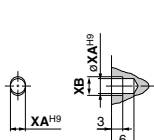

Detailed figure of section XX

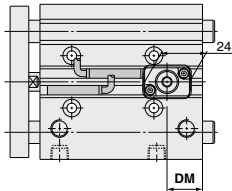

With head end lock

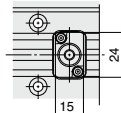

$\varnothing 25$

End lock mechanism (Manual release lock type)

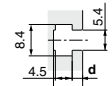
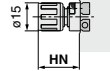

T-slot dimensions [mm]

Bore size [mm]	T-slot dimensions	
	d	e
20	2.8	7.8
25	3	8.2

∗: For intermediate strokes other than standard strokes, refer to the Manufacture of Intermediate Stroke on page 576.
∗∗: Rc, NPT and G ports can be selected. (Refer to page 575.)

MGPM, MGPL, MGPA Common Dimensions [mm]

Bore size [mm]	Standard stroke [mm]	B	C	DA	G	GA	GB	H	J	K	L	MM	ML	NN	P			PB	PW	Q	R	S
															NII	N	TF					
20	25, 50, 75, 100, 125, 150, 175, 200, 250, 300, 350, 400	78	62	10	36	10.5	8.5	83	18	18	24	M5 x 0.8	13	M5 x 0.8	Rc 1/8	NPT 1/8	G 1/8	10.5	25	18	70	30
25		78.5	62.5	12	42	11.5	9	93	21	21	30	M6 x 1.0	15	M6 x 1.0	Rc 1/8	NPT 1/8	G 1/8	13.5	30	26	78	38

Bore size [mm]	T	U	VA	VB	WA				WB				X	XA	XB
					75 st or less	Over 75 st to 175 st	Over 175 st to 250 st	Over 250 st	75 st or less	Over 75 st to 175 st	Over 175 st to 250 st	Over 250 st			
20	81	54	72	44	44	120	200	300	39	77	117	167	28	3	3.5
25	91	64	82	50	44	120	200	300	39	77	117	167	34	4	4.5

MGPL (Ball bushing),

MGPM (Slide bearing)/A, DB, E Dimensions [mm]

Bore size [mm]	A			DB	E		
	25 st or less	Over 25 st to 175 st	Over 175 st		25 st or less	Over 25 st to 175 st	Over 175 st
20	78	84.5	122	12	0	6.5	44
25	78.5	85	122	16	0	6.5	43.5

MGPA (High precision ball bushing)/A, DB, E Dimensions [mm]

Bore size [mm]	A			DB	E		
	75 st or less	Over 75 st to 175 st	Over 175 st		75 st or less	Over 75 st to 175 st	Over 175 st
20	80	104	122	10	2	26	44
25	85.5	104.5	122	13	7	26	43.5

End Lock Mechanism

Dimensions [mm]

Bore size [mm]	DL	DM	HR	HN
20	21	19	10.5	22
25	26.5	16	8	19.5

Dimensions: $\varnothing 32$ to $\varnothing 63$

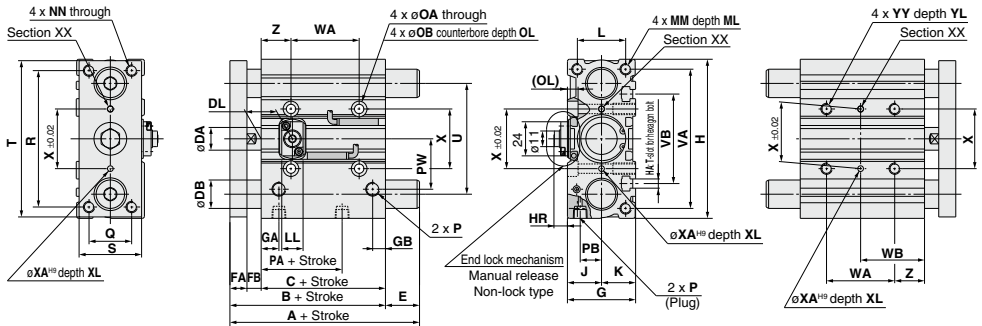

With rod end lock

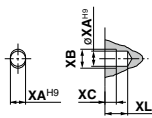

Detailed figure of section XX

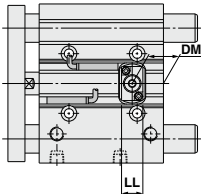

With head end lock

End lock mechanism (Manual release lock type)



T-slot dimensions [mm]

Bore size [mm]	T-slot dimensions				
	a	b	c	d	e
32	6.5	10.5	5.5	3.5	9.5
40	6.5	10.5	5.5	4	11
50	8.5	13.5	7.5	4.5	13.5
63	11	17.8	10	7	18.5

** For intermediate strokes other than standard strokes, refer to the Manufacture of Intermediate Stroke on page 576.
** Rc, NPT and G ports can be selected. (Refer to page 575.)

MGPM, MGPL Common Dimensions [mm]

Bore size [mm]	Standard stroke [mm]	B	C	DA	FA	FB	G	GA	GB	H	HA	J	K	L	MM	ML	NN	OA	OB	OL	P		
																					Nil	N	TF
32	25, 50, 75 100, 125, 150	84.5	62.5	16	12	10	48	12.5	9	112	M6	24	24	34	M8 x 1.25	20	M8 x 1.25	6.6	11	7.5	Rc1/8	NPT1/8	G1/8
40	30, 60, 90 120, 150, 180	91	69	16	12	10	54	14	10	120	M6	27	27	40	M8 x 1.25	20	M8 x 1.25	6.6	11	7.5	Rc1/8	NPT1/8	G1/8
50	40, 80, 120 160, 200, 250	97	69	20	16	12	64	14	11	148	M8	32	32	46	M10 x 1.5	22	M10 x 1.5	8.6	14	9	Rc1/4	NPT1/4	G1/4
63	50, 100, 150 200, 250, 300	102	74	20	16	12	78	16.5	13.5	162	M10	39	39	58	M10 x 1.5	22	M10 x 1.5	8.6	14	9	Rc1/4	NPT1/4	G1/4

Bore size [mm]	PA	PB	PW	Q	R	S	T	U	VA	VB	WA			WB			X	XA	XB	XC	XL	YY	YL	Z		
											75 st or less	Over 75 st to 175 st	Over 175 st to 250 st	75 st or less	Over 75 st to 175 st	Over 175 st to 250 st									Over 250 st	
32	32	15	35.5	30	96	44	110	78	98	63	48	124	200	300	45	83	121	171	42	4	4.5	3	6	M8 x 1.25	16	21
40	38	18	39.5	30	104	44	118	86	106	72	48	124	200	300	46	84	122	172	50	4	4.5	3	6	M8 x 1.25	16	22
50	34	21.5	47	40	130	60	146	110	130	92	48	124	200	300	48	86	124	174	66	5	6	4	8	M10 x 1.5	20	24
63	39	28	58	50	130	70	158	124	142	110	52	128	200	300	50	88	124	174	80	5	6	4	8	M10 x 1.5	20	24

MGPM (Slide bearing)/A, DB, E Dimensions [mm]

Bore size [mm]	A			DB	E		
	25 st or less	Over 25 st to 175 st	Over 175 st		25 st or less	Over 25 st to 175 st	Over 175 st
32	97	102	140	20	12.5	17.5	55.5
40	97	102	140	20	6	11	49
50	106.5	118	161	25	9.5	21	64
63	106.5	118	161	25	4.5	16	59

MGPL (Ball bushing), MGPA (High precision ball bushing)/A, DB, E Dimensions [mm]

Bore size [mm]	A				DB	E			
	25 st or less	Over 25 st to 75 st	Over 75 st to 175 st	Over 175 st		25 st or less	Over 25 st to 75 st	Over 75 st to 175 st	Over 175 st
32	84.5	98	118	140	16	0	13.5	33.5	55.5
40	91	98	118	140	16	0	7	27	49
50	97	114	134	161	20	0	17	37	64
63	102	114	134	161	20	0	12	32	59

End Lock Mechanism Dimensions [mm]

Bore size [mm]	DL	DM	HR	HN	LL	MO
32	22	22	9.5	21	15	15
40	26	23	11.5	25.5	21	19
50	24	23	13	27	21	19
63	25	25.5	11	25	21	19

MGP Series

Dimensions: $\varnothing 80, \varnothing 100$

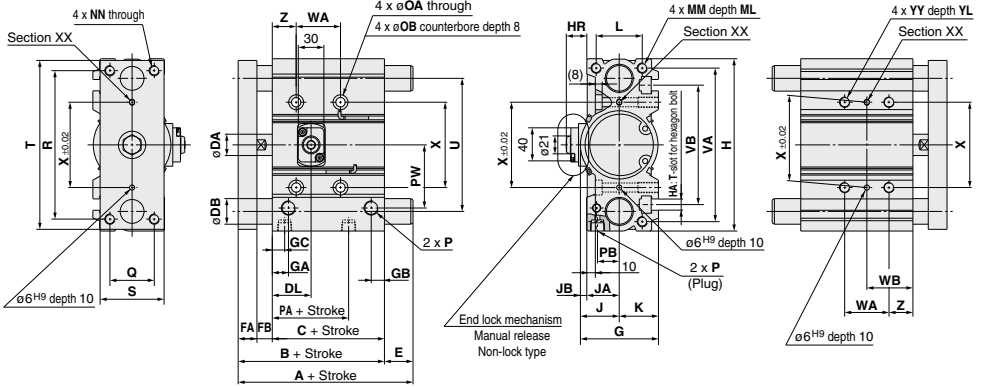

With rod end lock

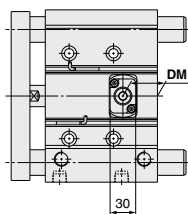

With head end lock

Detailed figure of section XX

End lock mechanism (Manual release lock type)

T-slot dimensions [mm]

Bore size [mm]	T-slot dimensions				
	a	b	c	d	e
80	13.3	20.3	12	8	22.5
100	15.3	23.3	13.5	10	30

*: For intermediate strokes other than standard strokes, refer to the Manufacture of Intermediate Stroke on page 576.

**: Rc, NPT and G ports can be selected. (Refer to page 575.)

MGPM, MGPL Common Dimensions [mm]

Bore size [mm]	Standard stroke [mm]										H	HA	J	JA	JB	K	L	MM	ML	NN	OA	OB
	B	C	DA	FA	FB	G	GA	GB	GC	GC												
80	25, 50, 75, 100, 125, 150, 175, 200, 250, 300, 350, 400	146.5	106.5	25	22	18	91.5	19	15.5	14.5	202	M12	45.5	38	7.5	46	54	M12 x 1.75	25	M12 x 1.75	10.6	17.5
100		166	116	30	25	25	111.5	23	19	18	240	M14	55.5	45	10.5	56	62	M14 x 2.0	31	M14 x 2.0	12.5	20

Bore size [mm]	P			PA	PB	PW	Q	R	S	T	U	VA	VB	WA			WB			X	YY	YL	Z		
	Nil	N	TF											50 st or less	Over 50 st to 150 st	Over 150 st to 250 st	Over 250 st	50 st or less	Over 50 st to 150 st					Over 150 st to 250 st	Over 250 st
80	Rc3/8	NPT3/8	G3/8	64.5	25.5	74	52	174	75	198	156	180	140	52	128	200	300	54	92	128	178	100	M12 x 1.75	24	28
100	Rc3/8	NPT3/8	G3/8	67.5	32.5	89	64	210	90	236	188	210	166	72	148	220	320	47	85	121	171	124	M14 x 2.0	28	11

MGPM (Slide bearing)/A, DB, E Dimensions [mm]

Bore size [mm]	A		DB	E	
	150 st or less	Over 150 st		150 st or less	Over 150 st
80	146.5	193	30	0	46.5
100	166	203	36	0	37

MGPL (Ball bushing),

MGPA (High precision ball bushing)/A, DB, E Dimensions [mm]

Bore size [mm]	A		DB	E	
	150 st or less	Over 150 st		150 st or less	Over 150 st
80	160	193	25	13.5	46.5
100	180	203	30	14	37

End Lock Mechanism

Dimensions [mm]

Bore size [mm]	DL	DM	HR	HN
80	45.5	40.5	24	38.5
100	49	43.5	26.5	41



MGP Series With End Lock

Specific Product Precautions

Be sure to read this before handling the products.
Refer to page 8 for safety instructions and pages 9 to 18 for actuator and auto switch precautions.

Use Recommended Air Pressure Circuit.

⚠ Caution

- It is necessary for proper locking and unlocking.

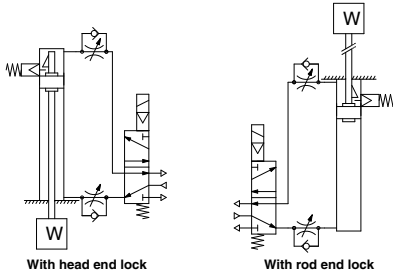

Handling

⚠ Caution

- Do not use a 3 position solenoid valve.**
Avoid using this cylinder in combination with a 3 position solenoid valve (particularly the closed center metal seal type). If air pressure becomes sealed inside the port on the side that contains the lock mechanism, the lock will not engage. Even if the lock is engaged at first, the air that leaks from the solenoid valve could enter the cylinder and cause the lock to disengage as time elapses.
- Back pressure is necessary for unlocking.**
Before starting, make sure that air is supplied to the side that is not equipped with a lock mechanism as shown in the diagram above. Otherwise, the lock may not disengage. (Refer to "Rock Disengagement".)
- Disengage the lock before installing or adjusting the cylinder.**
The lock could become damaged if the cylinder is installed with its lock engaged.
- Operate the cylinder at a load ratio of 50% or less.**
The lock might not disengage or might become damaged if a load ratio of 50% is exceeded.
- Do not synchronize multiple cylinders.**
Do not operate two or more end lock cylinders synchronized to move a single workpiece because one of the cylinder locks may not be able to disengage when required.
- Operate the speed controller under meter-out control.**
If operated under meter-in control, the lock might not disengage.
- On the side that has a lock, make sure to operate at the stroke end of the cylinder.**
The lock might not engage or disengage if the piston of the cylinder has not reached the stroke end.
- Do not use the air cylinder as an air-hydro cylinder. This may result in oil leak.**
- The position adjustment of the auto switch should be performed at two positions; a position determined by the stroke and a position after the backlash movement (by 2 mm).**
When a 2-color indicator auto switch is adjusted to show green at the stroke end, the indication may turn red when the cylinder returns by the backlash. This, however, is not an error.

Operating Pressure

⚠ Caution

- Supply air pressure of 0.15 MPa or higher to the port on the side that has the lock mechanism, as it is necessary for disengaging the lock.

Exhaust Air Speed

⚠ Caution

- The lock will engage automatically if the air pressure at the port on the side that has the lock mechanism becomes 0.05 MPa or less. Be aware that if the piping on the side that has the lock mechanism is narrow and long, or if the speed controller is located far from the cylinder port, the exhaust air speed could become slower, involving a longer time for the lock to engage. A similar result will ensure if the silencer that is installed on the exhaust port of the solenoid valve becomes clogged.

Lock Disengagement

⚠ Warning

- To disengage the lock, make sure to supply air pressure to the port on the side without a lock mechanism, thus preventing the load from being applied to the lock mechanism. (Refer to the recommended air pressure circuit.) If the lock is disengaged when the port on the side that does not contain a lock mechanism is in the exhausted state and the load is being applied to the lock mechanism, undue force will be applied to the lock mechanism, and it may damage the lock mechanism. Also, it could be extremely dangerous, because the piston rod could move suddenly.

Manual Disengagement

⚠ Caution

1. Non-locking type manual release

Insert the bolt, which is provided as an accessory part, through the rubber cap (it is not necessary to remove the rubber cap). Screw the bolt into the lock piston and pull the bolt to disengage the lock. Releasing the bolt will re-engage the lock.
The bolt size, pulling force, and the stroke are listed below.

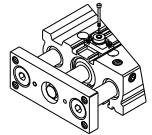

Bore size [mm]	Thread size	Pulling force	Stroke [mm]
20, 25, 32	M2.5 x 0.45 x 25 L or more	4.9 N	2
40, 50, 63	M3 x 0.5 x 30 L or more	10 N	3
80, 100	M5 x 0.8 x 40 L or more	24.5 N	3

Bolt should be detached under normal operation, otherwise it may cause malfunction of the locking feature.

2. Locking type manual release

Turn 90° counterclockwise while pushing the M/O knob. Lock is released when ▲ on the cap and ▼ OFF mark on the M/O knob correspond. (Lock remains released.)

When locking is desired, turn 90° clockwise while fully pushing the M/O knob and correspond ▲ on the cap and ▼ ON mark on the M/O knob. Confirm the correct position by click sound "click". Otherwise, lock may not be engaged.

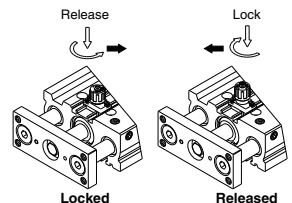

Compact Guide Cylinder/ Heavy Duty Guide Rod Type

MGPS Series

ø50, ø80

How to Order

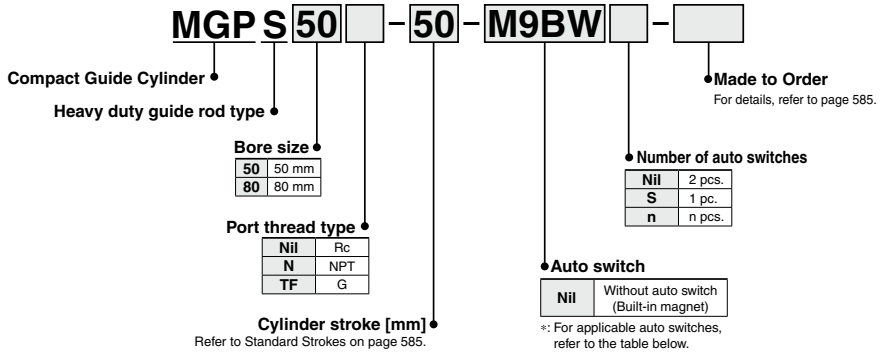

Applicable Auto Switches/Refer to pages 1289 to 1383 for further information on auto switches.

Type	Special function	Electrical entry	Indicator light	Wiring (Output)	Load voltage		Auto switch model		Lead wire length [m]			Pre-wired connector	Applicable load			
					DC	AC	Perpendicular	In-line	0.5 (Nil)	1 (M)	3 (L)		5 (Z)			
Solid state auto switch	—	Grommet	Yes	3-wire (NPN)	5 V, 12 V	—	M9NV	M9N	●	●	●	○	○	IC circuit	Relay, PLC	
				3-wire (PNP)			M9PV	M9P	●	●	●	○	○			
	2-wire			12 V	M9BV		M9B	●	●	●	○	○	—			
	3-wire (NPN)			5 V, 12 V	M9NWV		M9NW	●	●	●	○	○	IC circuit			
	3-wire (PNP)				M9PWV		M9PW	●	●	●	○	○				
	Diagnostic indication (2-color indicator)			2-wire	12 V		M9BWV	M9BW	●	●	●	○	○	—		
				Water resistant (2-color indicator)	3-wire (NPN)		5 V, 12 V	M9NAV ^{*1}	M9NA ^{*1}	○	○	●	○	○		IC circuit
	3-wire (PNP)				M9PAV ^{*1}			M9PA ^{*1}	○	○	●	○	○			
Magnetic field resistant (2-color indicator)	2-wire (Non-polar)	—	—	M9BAV ^{*1}	M9BA ^{*1}	○	○	○	○	○	—					
				—	P3DWA	●	—	●	●	○	—					
Reed auto switch	—	Grommet	Yes	3-wire (NPN equivalent)	—	5 V	A96V	A96	●	—	●	—	—	IC circuit	—	
				2-wire			24 V	12 V	100 V	A93V ^{*2}	A93	●	●	●	—	—
				2-wire	24 V		12 V	100 V or less	A90V	A90	●	—	●	—	—	IC circuit

*1: Water resistant type auto switches can be mounted on the above models, but in such case SMC cannot guarantee water resistance.

Please consult with SMC regarding water resistant types with the above model numbers.

*2: 1 m type lead wire is only applicable to the D-A93.

*: Lead wire length symbols: 0.5 m..... Nil (Example) M9NW
1 m..... M (Example) M9NWM
3 m..... L (Example) M9NWL
5 m..... Z (Example) M9NZZ

*: Solid state auto switches marked with "○" are produced upon receipt of order.

*: Since there are other applicable auto switches than listed above, refer to page 595 for details.

*: For details about auto switches with pre-wired connector, refer to pages 1358 and 1359.

*: Auto switches are shipped together, (but not assembled).

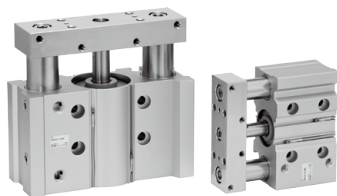

Symbol
Rubber bumper

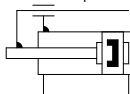

Made to Order: Individual Specifications
(For details, refer to pages 597 and 598.)

Symbol	Specifications
-XB67	Side porting type (Plug location changed) *1

*1: The shape is the same as the current product.



Made to Order
[Click here for details](#)

Symbol	Specifications
-XB13	Low speed cylinder (5 to 50 mm/s)
-XC85	Grease for food processing equipment
-XC22	Fluororubber seals

Refer to pages 592 to 596 for cylinders with auto switches.

- Minimum stroke for auto switch mounting
- Auto switch proper mounting position (detection at stroke end) and its mounting height
- Operating range
- Auto switch mounting brackets/Part no.
- Auto switch mounting

Specifications

Bore size [mm]	50	80
Action	Double acting	
Fluid	Air	
Proof pressure	1.5 MPa	
Maximum operating pressure	1.0 MPa	
Minimum operating pressure	0.1 MPa	
Ambient and fluid temperature	-10 to 60°C (No freezing)	
Piston speed *1	50 to 400 mm/s	
Cushion	Rubber bumper on both ends	
Lubrication	Not required (Non-lube)	
Stroke length tolerance	+1.5 -0 mm	

*1: Maximum speed with no load. Depending on the operating conditions, the piston speed may not be satisfied. Make a model selection, considering a load according to the graph on pages 586 to 588.

Standard Strokes

Bore size [mm]	Standard stroke [mm]
50, 80	25, 50, 75, 100, 125, 150, 175, 200

Manufacture of Intermediate Stroke

Description	Spacer installation type Spacers are installed in the standard stroke cylinder. Available in 5 mm stroke increments.
Part no.	Refer to "How to Order" for the standard model numbers on page 584.
Applicable stroke [mm]	5 to 195
Example	Part no.: MGPS50-35 A spacer 15 mm in width is installed in a MGPS50-50. C dimension is 94 mm.

*: Intermediate stroke (in 1 mm increments) based on an exclusive body will be available upon request for special.

Theoretical Output



Bore size [mm]	Rod size [mm]	Operating direction	Piston area [mm ²]	Operating pressure [MPa]										
				0.2	0.3	0.4	0.5	0.6	0.7	0.8	0.9	1.0		
50	20	OUT	1963	393	589	785	982	1178	1374	1571	1767	1963		
		IN	1649	330	495	660	825	990	1155	1319	1484	1649		
80	25	OUT	5027	1005	1508	2011	2513	3016	3519	4021	4524	5027		
		IN	4536	907	1361	1814	2268	2721	3175	3629	4082	4536		

*: Theoretical output [N] = Pressure [MPa] x Piston area [mm²]

Weights

Bore size [mm]	Standard stroke [mm]								[kg]
	25	50	75	100	125	150	175	200	
50	3.90	4.68	5.74	6.52	7.30	8.08	8.86	9.64	
80	9.21	10.7	13.0	14.5	15.9	17.9	18.9	20.3	

Allowable Rotational Torque of Plate

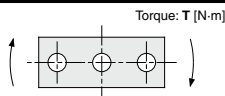

Bore size [mm]	Standard stroke [mm]								T [N·m]
	25	50	75	100	125	150	175	200	
50	15	12	16	15	13	12	11	9.8	
80	49	41	51	45	41	38	35	32	

Non-rotating Accuracy of Plate

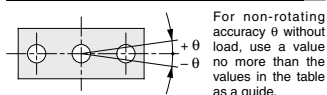

Bore size [mm]	Non-rotating accuracy θ
50	$\pm 0.05^\circ$
80	$\pm 0.04^\circ$

For non-rotating accuracy θ without load, use a value no more than the values in the table as a guide.

MGPS Series Model Selection

Selection Conditions

Mounting orientation	Vertical		Horizontal	
Maximum speed [mm/s]	200 or less	400	200 or less	400
Graph (Slide bearing type)	(1), (2)	(3), (4)	(5), (6)	(7), (8)

Selection Example 1 (Vertical Mounting)

Selection conditions

Mounting: Vertical
Stroke: 50 stroke
Maximum speed: 200 mm/s
Load mass: 100 kg
Eccentric distance: 100 mm

Find the point of intersection for the load mass of 100 kg and the eccentric distance of 100 mm on graph 1, based on vertical mounting, 50 mm stroke, and the speed of 200 mm/s.

→ **MGPS80-50** is selected.

(1) 50 stroke or less, $V = 200$ mm/s or less

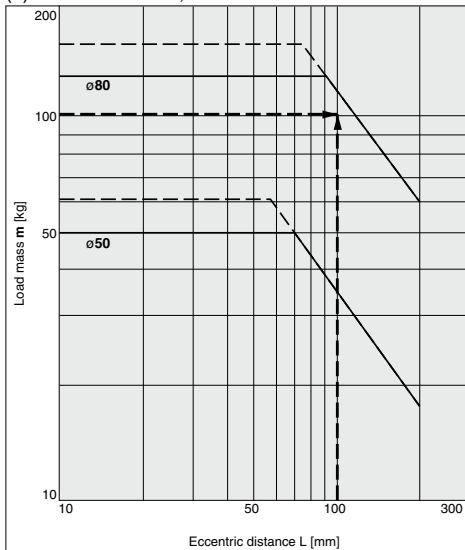

Selection Example 2 (Horizontal Mounting)

Selection conditions

Mounting: Horizontal
Distance between plate and load center of gravity: 50 mm
Maximum speed: 200 mm/s
Load mass: 30 kg
Stroke: 100 stroke

Find the point of intersection for the load mass of 30 kg and 100 stroke on graph 5, based on horizontal mounting, the distance of 50 mm between the plate and load center of gravity, and the speed of 200 mm/s.

→ **MGPS80-100** is selected.

(5) $L = 50$ mm, $V = 200$ mm/s or less

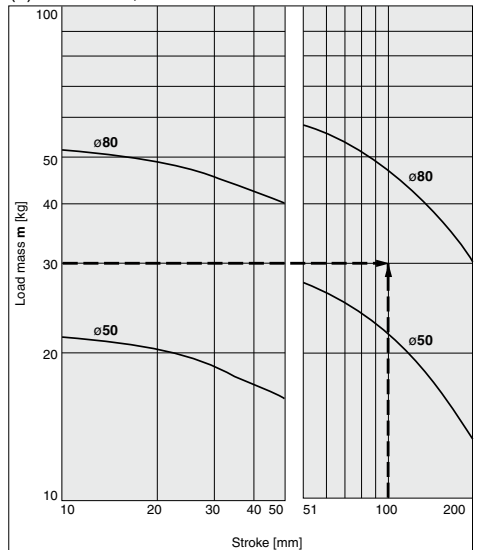

When the maximum speed exceeds 200 mm/s, the allowable load mass is determined by multiplying the value shown in the graph at 400 mm/s by the coefficient listed in the table below.

Maximum	Up to 300 mm/s	Up to 400 mm/s	Up to 500 mm/s
Coefficient	1.7	1	0.6

Use the Guide Cylinder Selection Software, when the eccentric distance is 200 mm or more.

Vertical Mounting Slide Bearing

— Operating pressure 0.4 MPa
 - - - Operating pressure 0.5 MPa or more

MGPS50, 80

(1) 50 Stroke or Less, $V = 200$ mm/s or less

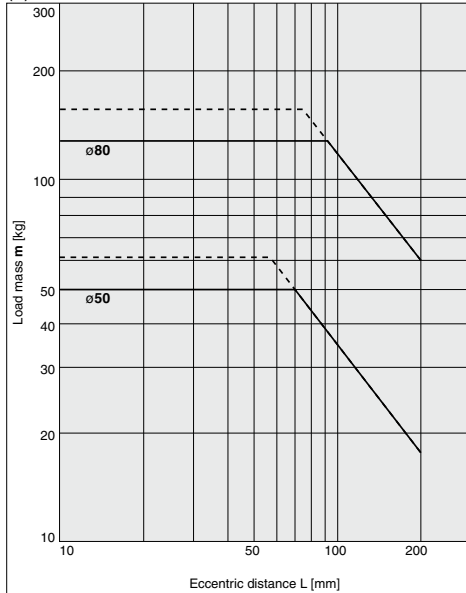

(2) Over 50 Stroke, $V = 200$ mm/s or less

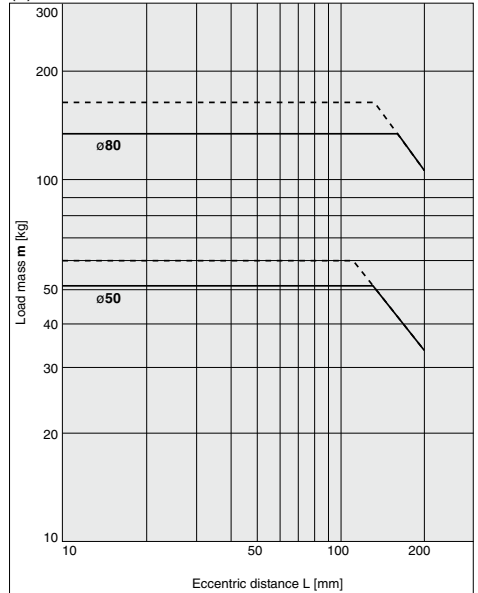

(3) 50 Stroke or Less, $V = 400$ mm/s

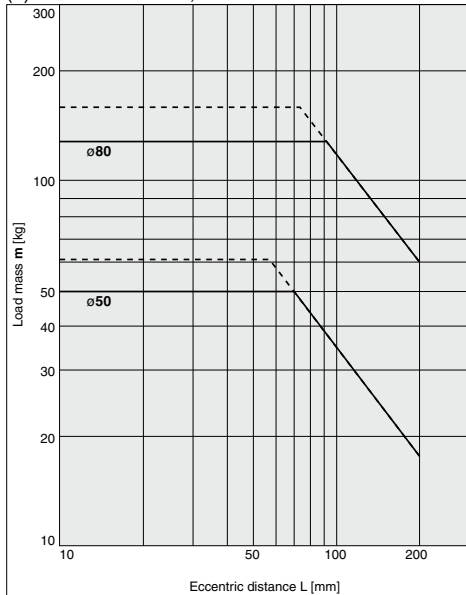

(4) Over 50 Stroke, $V = 400$ mm/s

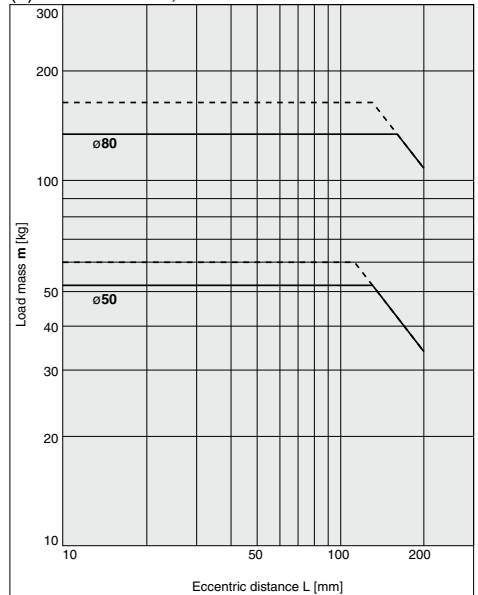

· Use the Guide Cylinder Selection Software, when the eccentric distance is 200 mm or more.

MGPS50, 80

(5) L = 50 mm, V = 200 mm/s or less

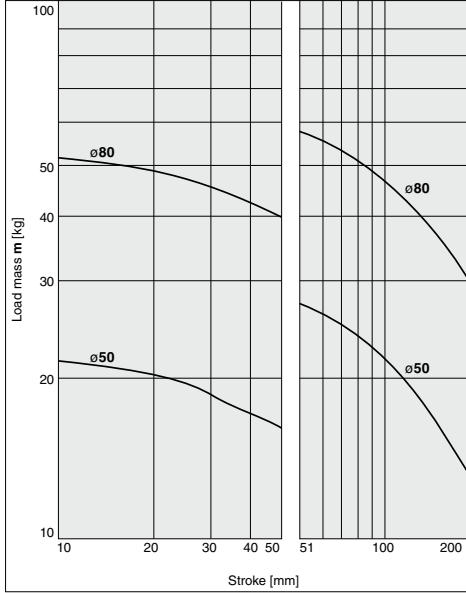

(6) L = 100 mm, V = 200 mm/s or less

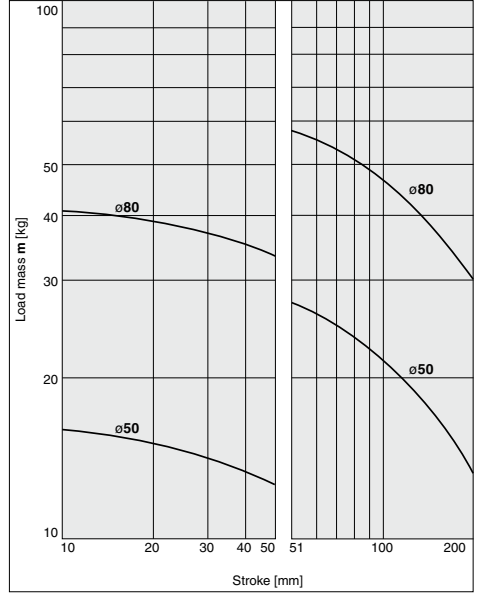

(7) L = 50 mm, V = 400 mm/s

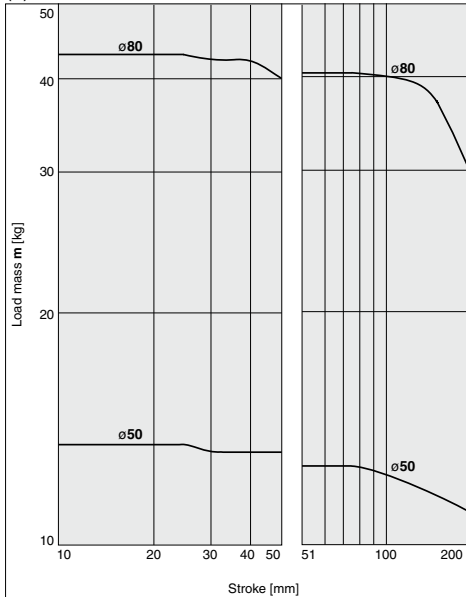

(8) L = 100 mm, V = 400 mm/s

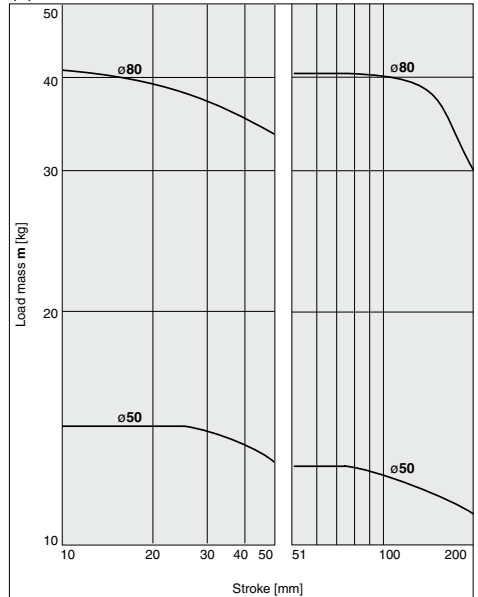

Operating Range when Used as Stopper

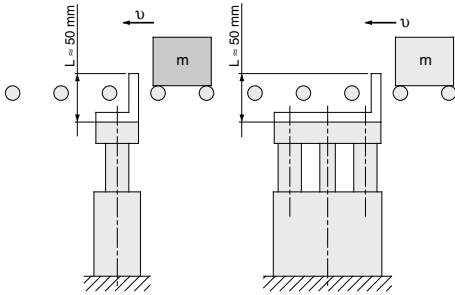

- *: When selecting a model with a longer L dimension, be sure to choose a bore size which is sufficiently large.
- *: Refer to the horizontal mounting selection graph if line pressure is to be applied by a roller conveyor after the workpiece is stopped.

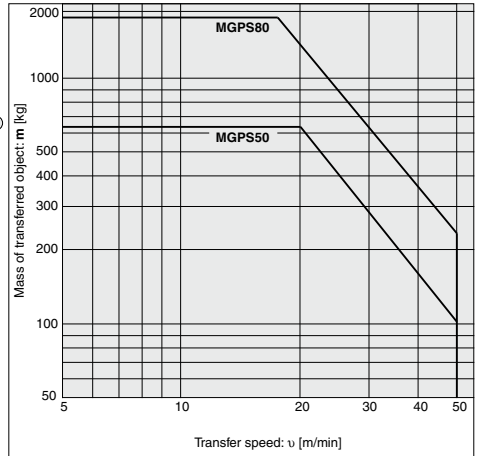

Caution

Caution on handling

When using as a stopper, select a model with 50 stroke or less.

MGPS Series

Construction

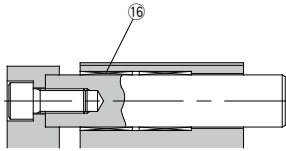

Over 50 stroke

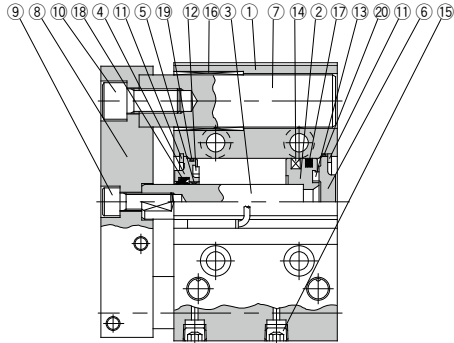

50 stroke or less

Component Parts

No.	Description	Material	Note
1	Body	Aluminum alloy	Hard anodized
2	Piston	Aluminum alloy	
3	Piston rod	Carbon steel	Hard chrome plating
4	Collar	Aluminum alloy casted	Painted
5	Bushing	Bearing alloy	
6	Head cover	Aluminum alloy	ø50 Chromated
			ø80 Painted
7	Guide rod	Carbon steel	Hard chrome plating
8	Plate	Carbon steel	Nickel plating
9	Plate mounting bolt A	Carbon steel	Nickel plating For piston rod
10	Plate mounting bolt B	Carbon steel	Nickel plating For guide rod

Component Parts

No.	Description	Material	Note
11	Retaining ring	Carbon tool steel	Phosphate coated
12	Bumper A	Urethane	
13	Bumper B	Urethane	
14	Magnet	—	
15	Hexagon socket head taper plug	Carbon steel	Nickel plating
16	Slide Bearing	Bearing alloy	
17*	Piston seal	NBR	
18*	Rod seal	NBR	
19*	Gasket A	NBR	
20*	Gasket B	NBR	

Replacement Parts/Seal Kit

Bore size [mm]	Kit no.	Contents
50	MGP50-PS	Set of nos. above 17, 18, 19, 20
80	MGP80-PS	

- *: Seal kit includes 17 to 20. Order the seal kit, based on each bore size.
 *: Since the seal kit does not include a grease pack, order it separately.
Grease pack part no.: GR-S-010 (10 g)

Dimensions

MGPS50, 80

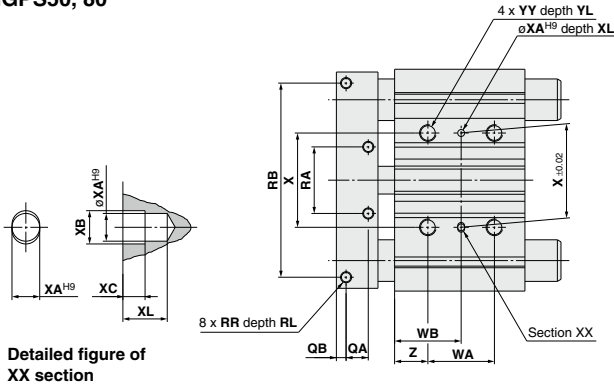

T-slot dimensions

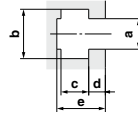

Bore size [mm]	T-slot dimensions [mm]				
	a	b	c	d	e
50	11	17.8	10	6	17.5
80	13.3	20.3	12	8	22.5

Detailed figure of XX section

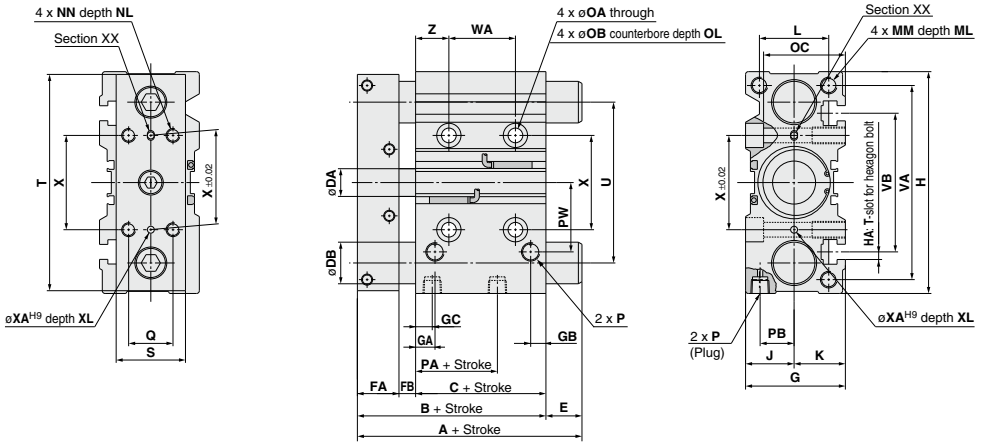

*: For intermediate strokes other than standard strokes, refer to the Manufacture of Intermediate Stroke on page 585.
*: Rc, NPT and G ports can be selected. (Refer to page 584.)

Dimensions

Bore size [mm]	Standard stroke [mm]	A		B	C	DA	DB	E		FA	FB	G	GA	GB	GC	H	HA	J	K	L
		25, 50 st	Over 50 st					25, 50 st	Over 50 st											
50	25, 50, 75, 100	86	110	86	44	20	30	0	24	29.5	12.5	72	14	11	12	160	M10	35	37	50
80	125, 150, 175, 200	118	151	118	65	25	45	0	33	35	18	95	19	24	14.5	242	M12	47	48	66
Bore size [mm]	MM	ML	NN	NL	OA	OB	OC	OL	P			PA	PB	PW	Q	QA	QB	RA	RB	RR
									Nii	N	TF									
50	M12 x 1.75	20	M10 x 1.5	20	10.6	17.5	59	13	Rc 1/4	NPT 1/4	G 1/4	9	24.5	50	32	16	7	48	140	M8 x 1.25
80	M16 x 2.0	32	M12 x 1.75	24	12.5	20	72	17.5	Rc 3/8	NPT 3/8	G 3/8	14.5	29	77	40	18	9	80	200	M10 x 1.5
Bore size [mm]	RL	S	T	U	VA	VB	WA			WB			X	XA	XB	XC	XL	YY	YL	Z
							25 st	50, 75, 100 st	Over 100 st	25 st	50, 75, 100 st	Over 100 st								
50	14	50	156	116	140	100	24	48	124	36	48	86	68	5	6	4	8	M12 x 1.75	24	24
80	20	65	228	170	214	138	28	52	128	42	54	92	100	6	7	5	10	M14 x 2.0	28	28

MGP Series Auto Switch Mounting

Auto Switch Proper Mounting Position (Detection at stroke end) and Its Mounting Height/MGP-Z (Basic type), MGP-AZ (Air cushion), MGPS (Heavy duty guide rod type)

D-M9□/M9□V
 D-M9□W/M9□WV
 D-M9□A/M9□AV
 D-A9□/A9□V

φ12 to φ100

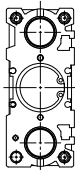
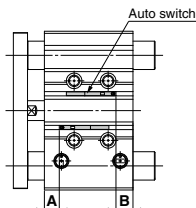

D-P3DWA

φ25 to φ63

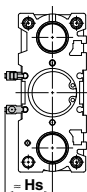
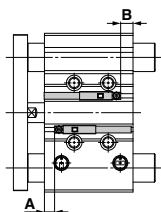

φ80, φ100

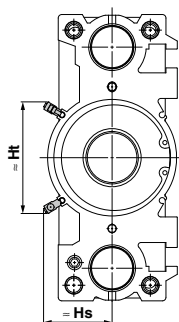

D-P4DW

φ32 to φ63

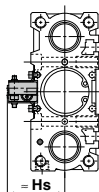
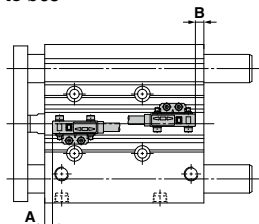

φ80, φ100

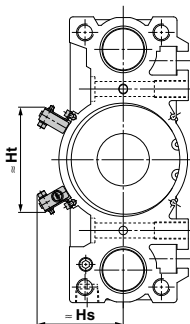

*: The MGP-Z (Basic type) is shown as a representative example.

Applicable Cylinder: MGP-Z (Basic type)

Auto Switch Proper Mounting Position [mm]

Auto switch model	D-M9□ D-M9□V D-M9□WV D-M9□A D-M9□AV		D-A9□ D-A9□V		D-P3DWA		D-P4DW ^{*1}	
	A	B	A	B	A	B	A	B
Bore size								
12	7.5	9.5	3.5	5.5	—	—	—	—
16	10.5	10.5	6.5	6.5	—	—	—	—
20	12.5	12.5	8.5	8.5	—	—	—	—
25	11.5	14	7.5	10	7	9.5	—	—
32	12.5	13	8.5	9	8	8.5	5.5	6
40	15.5	16.5	11.5	12.5	11	12	8.5	9.5
50	14.5	17	10.5	13	10	12.5	7.5	10
63	16.5	20	12.5	16	12	15.5	9.5	13
80	18	26	14	22	13.5	21.5	11	19
100	21.5	32.5	17.5	28.5	17	28	14.5	25.5

*1: The auto switch mounting bracket BMG7-032 is used.
 *: Adjust the auto switch after confirming the operating conditions in the actual setting.

Applicable Cylinder: MGP-Z (Basic type)

Auto Switch Proper Mounting Height [mm]

Auto switch model	D-M9□V D-M9□WV D-M9□AV		D-A9□V		D-P3DWA		D-P4DW ^{*1}	
	Hs	Ht	Hs	Ht	Hs	Ht	Hs	Ht
Bore size								
12	19.5	—	17	—	—	—	—	—
16	22	—	19.5	—	—	—	—	—
20	24.5	—	22	—	—	—	—	—
25	26	—	24	—	32.5	—	—	—
32	29	—	26.5	—	35.5	—	40	—
40	33	—	30.5	—	39	—	44	—
50	38.5	—	36	—	44.5	—	49.5	—
63	45.5	—	43	—	51.5	—	56.5	—
80	45	74	43	71.5	49.5	80.5	61	74
100	55	85.5	53	83	59.5	92	71.5	86

*1: The auto switch mounting bracket BMG7-032 is used.

Applicable Cylinder: MGP-AZ (Air cushion)

Auto Switch Proper Mounting Position [mm]

Auto switch model	D-M9□ D-M9□V D-M9□WV D-M9□A D-M9□AV		D-A9□ D-A9□V		D-P3DWA		D-P4DW ^{*1}	
	A	B	A	B	A	B	A	B
Bore size								
16	25	20.5	21	16.5	—	—	—	—
20	27	23	23	19	—	—	—	—
25	27	23	23	19	22.5	18.5	—	—
32	21	29	17	25	16.5	24.5	14	22
40	25.5	31.5	21.5	27.5	21	27	18.5	24.5
50	26	30.5	22	26.5	21.5	26	19	23.5
63	30	31.5	26	27.5	25.5	27	23	24.5
80	30.5	38.5	26.5	34.5	26	34	23.5	31.5
100	34.5	44	30.5	40	30	39.5	27.5	37

*1: The auto switch mounting bracket BMG7-032 is used.

Applicable Cylinder: MGP-AZ (Air cushion)

Auto Switch Proper Mounting Height [mm]

Auto switch model	D-M9□V D-M9□WV D-M9□AV		D-A9□V		D-P3DWA		D-P4DW ^{*1}	
	Hs	Ht	Hs	Ht	Hs	Ht	Hs	Ht
Bore size								
16	22	—	19.5	—	—	—	—	—
20	24.5	—	22	—	—	—	—	—
25	26	—	24	—	32.5	—	—	—
32	29	—	26.5	—	35.5	—	40	—
40	33	—	30.5	—	39	—	44	—
50	38.5	—	36	—	44.5	—	49.5	—
63	45.5	—	43	—	51.5	—	56.5	—
80	45	74	43	71.5	49.5	80.5	61	74
100	55	85.5	53	83	59.5	92	71.5	86

*1: The auto switch mounting bracket BMG7-032 is used.

Applicable Cylinder: MGPS (Heavy duty guide rod)

Auto Switch Proper Mounting Position [mm]

Auto switch model	D-M9□ ^{*1} D-M9□V D-M9□W D-M9□WV D-M9□A D-M9□AV		D-A9□ ^{*1} D-A9□V		D-Z7□ D-Z80 D-Y59□ D-Y7P D-Y69□ D-Y7PV D-Y7□W D-Y7 D-WV D-Y7BA		D-P3DWA ^{*1}		D-P4DW ^{*2}	
	A	B	A	B	A	B	A	B	A	B
Bore size										
50	12.5	16.5	8.5	12.5	7.5	11.5	8	12	7	11
80	18	23.5	14	19.5	13	18.5	13.5	19	12.5	18

*1: The auto switch mounting bracket BMG2-012 is used.
 *2: The auto switch mounting bracket BMG1-040 is used.
 *: Adjust the auto switch after confirming the operating conditions in the actual setting.

Applicable Cylinder: MGPS (Heavy duty guide rod)

Auto Switch Proper Mounting Height [mm]

Auto switch model	D-M9□ ^{*1} D-M9□V D-M9□W D-M9□WV D-M9□A D-M9□AV		D-A9□V		D-Y69□ D-Y7PV D-Y7□WV		D-P3DWA ^{*2}		D-P4DW ^{*3}		
	Hs	Ht	Hs	Ht	Hs	Ht	Hs	Ht	Hs	Ht	
Bore size											
50	32.5	38.5	—	36	—	34	—	44.5	—	50	—
80	40	45	74	43	71.5	41	70	49.5	78.5	61	84.5

*1: For the D-M9□, the auto switch mounting bracket BMG2-012 is used.
 *2: The auto switch mounting bracket BMG2-012 is used.
 *3: The auto switch mounting bracket BMG1-040 is used.

MGP Series

Auto Switch Proper Mounting Position (Detection at stroke end) and Its Mounting Height/MGP (With end lock)

Applicable cylinder: MGP series, With end lock

With rod end lock

D-M9□	D-M9□A	D-Z7□	D-Y7P
D-M9□V	D-M9□AV	D-Z80	D-Y7PV
D-M9□W	D-A9□	D-Y59□	D-Y7□W
D-M9□WV	D-A9□V	D-Y69□	D-Y7□WV
			D-Y7BA

Auto Switch Proper Mounting Position

Auto switch model	D-M9□ ^{*1}		D-A9□ ^{*1}		D-Z7□/Z80		D-Y59□/Y7P		D-Y69□/Y7PV		D-P3DWA ^{*3,*4}		D-P4DW ^{*2}			
	D-M9□V	D-M9□W	D-M9□WV	D-M9□AV	D-M9□V	D-M9□W	D-M9□WV	D-M9□AV	D-Z7□	D-Z80	D-Y59□	D-Y7P	D-Y69□	D-Y7PV	D-Y7□W	D-Y7□WV
Bore size	A	B	A	B	A	B	A	B	A	B	A	B	A	B		
20	40	7	36	3	35	2	—	—	—	—	—	—	—	—		
25	40.5	7	36.5	3	35.5	2	36	2.5 ^{*5}	—	—	—	—	—	—		
32	37.5	10	33.5	6	32.5	5	33	6	32	4.5	—	—	—	—		
40	43.5	10.5	39.5	6.5	38.5	5.5	39	6	38	5	—	—	—	—		
50	44.5	9.5	40.5	5.5	39.5	4.5	40	5	39	4	—	—	—	—		
63	47	12	43	8	42	7	42.5	7.5	41.5	6.5	—	—	—	—		
80	68	23.5	64	19.5	63	18.5	63.5	19	62.5	18	—	—	—	—		
100	72.5	28.5	68.5	24.5	67.5	23.5	68	24	67	23	—	—	—	—		

- *1: The auto switch mounting bracket BMG2-012 is used.
- *2: The auto switch mounting bracket BMG1-040 is used.
- *3: The auto switch mounting bracket BMG10-025 is used.
- *4: This shows the top end position of the mounting bracket when the auto switch is put in contact with the mounting bracket.
- *5: When mounted on the head end of ø25, the tip of the BMG2-012 protrudes 3.5 mm from the cylinder body.
- *: Adjust the auto switch after confirming the operating conditions in the actual setting.

Auto Switch Proper Mounting Height (D-P3DWA)

Bore size	Hs	Ht
25	32	—
32	35	—
40	39	—
50	44.5	—
63	51.5	—
80	49.5	78.5
100	60	90

Auto Switch Proper Mounting Height (D-P4DW)

Bore size	Hs	Ht
32	41.5	—
40	44.5	—
50	50	—
63	57	—
80	61	84.5
100	71	96.5

With head end lock

D-M9□	D-M9□A	D-Z7□	D-Y7P
D-M9□V	D-M9□AV	D-Z80	D-Y7PV
D-M9□W	D-A9□	D-Y59□	D-Y7□W
D-M9□WV	D-A9□V	D-Y69□	D-Y7□WV
			D-Y7BA

Auto Switch Proper Mounting Position

Auto switch model	D-M9□ ^{*1}		D-A9□ ^{*1}		D-Z7□/Z80		D-Y59□/Y7P		D-Y69□/Y7PV		D-P3DWA ^{*3,*4}		D-P4DW ^{*2}			
	D-M9□V	D-M9□W	D-M9□WV	D-M9□AV	D-M9□V	D-M9□W	D-M9□WV	D-M9□AV	D-Z7□	D-Z80	D-Y59□	D-Y7P	D-Y69□	D-Y7PV	D-Y7□W	D-Y7□WV
Bore size	A	B	A	B	A	B	A	B	A	B	A	B	A	B		
20	9	38	5	34	4	33	—	—	—	—	—	—	—	—		
25	9.5	38	5.5	34	4.5	33	6	33.5	—	—	—	—	—	—		
32	10.5	37	6.5	33	5.5	32	6	32.5	5	31.5	—	—	—	—		
40	14.5	39.5	10.5	35.5	9.5	34.5	10	35	9	34	—	—	—	—		
50	12.5	41.5	8.5	37.5	7.5	36.5	8	37	7	36	—	—	—	—		
63	15	44	11	40	10	39	10.5	39.5	9.5	38.5	—	—	—	—		
80	18	73.5	14	69.5	13	68.5	13.5	69	12.5	68	—	—	—	—		
100	22.5	78.5	18.5	74.5	17.5	73.5	18	74	17	73	—	—	—	—		

- *1: The auto switch mounting bracket BMG2-012 is used.
- *2: The auto switch mounting bracket BMG1-040 is used.
- *3: The auto switch mounting bracket BMG10-025 is used.
- *4: This shows the top end position of the mounting bracket when the auto switch is put in contact with the mounting bracket.
- *: Adjust the auto switch after confirming the operating conditions in the actual setting.

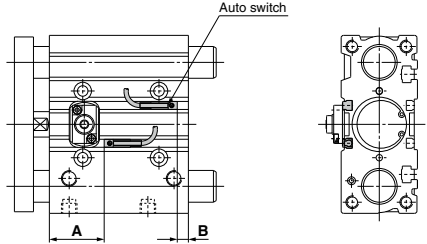

For D-P3DWA (*: Cannot be mounted on bore size ø20.)

ø25 to ø63

ø80, ø100

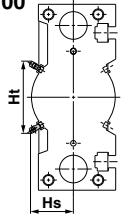
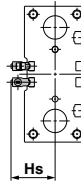

For D-P4DW (*: Cannot be mounted on bore size ø25 or less.)

ø32 to ø63

ø80, ø100

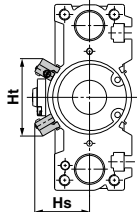
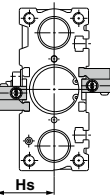
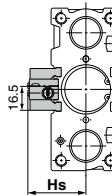

For 25 stroke

*: For bore sizes ø40 to ø63 with two auto switches, one switch is mounted on each side.

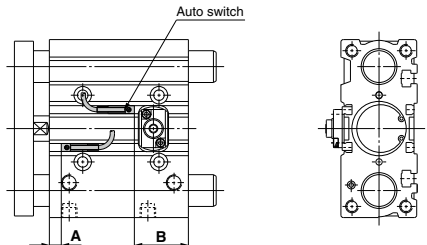

Mounting of Auto Switch

⚠ Caution

In the case of 25 st or less with head side end lock type, it might not insert auto switch from the rod side. In this case, install it after removing the plate temporarily. Regarding the plate removal and the way of assembly, please consult with SMC.

Minimum Stroke for Auto Switch Mounting

		[mm]										
Auto switch model	Number of auto switches	ø12	ø16	ø20	ø25	ø32	ø40	ø50	ø63	ø80	ø100	
D-M9□V	1 pc.						5					
	2 pcs.						5					
D-M9□	1 pc.	5 *1							10			
	2 pcs.	10 *1							5			
D-M9□W	1 pc.						5 *2					
	2 pcs.	10 *2					10					
D-M9□WV	1 pc.						5 *2					
	2 pcs.						10					
D-M9□AV	1 pc.						5 *2					
	2 pcs.						10 *2					
D-M9□A	1 pc.	5 *1										
	2 pcs.	10 *1					5					
D-A9□	1 pc.						10					
	2 pcs.						5					
D-A9□V	1 pc.						5					
	2 pcs.						10					
D-Z7□	1 pc.	—		5 *1					5			
	2 pcs.	—		5 *1					10			
D-Y59□	1 pc.	—		5 *1					5			
	2 pcs.	—		5 *1					10			
D-Y7P□	1 pc.	—							5			
	2 pcs.	—							5			
D-Y7□W	1 pc.	—							5 *2			
	2 pcs.	—							10 *2			
D-Y7□WV	1 pc.	—							5 *2			
	2 pcs.	—							10 *2			
D-Y7BA	1 pc.	—							5 *2			
	2 pcs.	—							10 *2			
D-P3DWA	1 pc.	—							15 *2			
	2 pcs.	—							15 *2			
D-P4DW	1 pc.	—							5 *2			
	2 pcs. (Different surfaces)	—							10 *2			
	2 pcs. (Same surface)	—					75		10			

*1: Confirm that it is possible to secure the minimum bending radius of 10 mm of the auto switch lead wire before use.

*2: Confirm that it is possible to securely set the auto switch(es) within the range of indicator green light ON range before use.
For in-line entry type, also consider *1 shown above.

Operating Range

		[mm]									
Auto switch model	Bore size										
	12	16	20	25	32	40	50	63	80	100	
D-M9□/M9□V	3.5	5	5	5	6	6	6	6.5	6	7	
D-M9□W/M9□WV											
D-M9□A/M9□AV											
D-A9□/A9□V	7	9	9	9	9.5	9.5	9.5	11	10.5	10.5	
D-Z7□/Z80	—	—	10	10	10.5	10.5	10.5	11.5	11.5	12	
D-Y59□/Y69□	—	—	7.5	7	6.5	6	7	8	9.5	10	
D-Y7P□/Y7PV											
D-Y7□W/Y7□WV											
D-Y7BA	—	—	—	5.5	6.5	6	6	6.5	6	7	
D-P3DWA	—	—	—	—	5	4	4	5	4	4	
D-P4DW	—	—	—	—	5	4	4	5	4	4	

*: Values which include hysteresis are for guideline purposes only, they are not a guarantee (assuming approximately ±30% dispersion) and may change substantially depending on the ambient environment.

Other than the applicable auto switches listed in How to Order, the following auto switches are mountable.

*: The auto switches other than the D-P4DW are mountable on the models with end lock and heavy duty guide rod type only.

Refer to pages 1289 to 1383 for the detailed specifications.

Type	Model	Electrical entry	Features
Reed	D-Z73, Z76	Grommet (In-line)	—
	D-Z80		Without indicator light
Solid state	D-P4DW	Grommet (In-line)	Magnetic field resistant (2-color indicator) Bore size: ø32 to ø100
	D-Y69A, Y69B, Y7PV	Grommet (Perpendicular)	—
	D-Y7NWV, Y7PWV, Y7BWW		Diagnostic indication (2-color indicator)
	D-Y59A, Y59B, Y7P	Grommet (In-line)	—
	D-Y7NW, Y7PW, Y7BW		Diagnostic indication (2-color indicator)
	D-Y7BA		Water resistant (2-color indicator)

*: With pre-wired connector is also available for solid state auto switches.

For details, refer to pages 1358 and 1359.

*: Normally closed (NC = b contact) solid state auto switches (D-M9□E(V)) are also available.

For details, refer to page 1308.

*: When installing the D-P4DW, use the BMG7-032 auto switch mounting bracket.

Auto Switch Mounting

Applicable Cylinder: MGP-Z (Basic type), MGP-AZ (Air cushion)

Applicable auto switches	D-M9□/M9□V D-M9□W/M9□WV D-M9□A/M9□AV D-A9□/A9□V	D-P3DWA						
Bore size [mm]	ø12 to ø100	ø25 to ø100						
Auto switch tightening torque	<table border="1"> <thead> <tr> <th>Auto switch model</th> <th>Tightening torque [N·m]</th> </tr> </thead> <tbody> <tr> <td>D-M9□(V) D-M9□W(V) D-A93</td> <td>0.05 to 0.15</td> </tr> <tr> <td>D-M9□A(V) D-A9□(V) (Excludes the D-A93)</td> <td>0.05 to 0.10 0.10 to 0.20</td> </tr> </tbody> </table>	Auto switch model	Tightening torque [N·m]	D-M9□(V) D-M9□W(V) D-A93	0.05 to 0.15	D-M9□A(V) D-A9□(V) (Excludes the D-A93)	0.05 to 0.10 0.10 to 0.20	0.2 to 0.3 N·m
Auto switch model	Tightening torque [N·m]							
D-M9□(V) D-M9□W(V) D-A93	0.05 to 0.15							
D-M9□A(V) D-A9□(V) (Excludes the D-A93)	0.05 to 0.10 0.10 to 0.20							

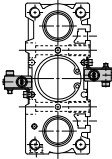
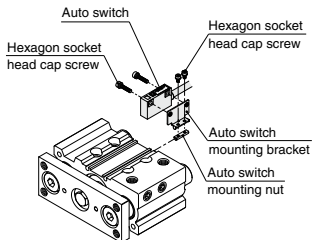
Applicable auto switches	D-P4DW
Bore size [mm]	ø32 to ø100
Auto switch mounting bracket part no.	BMG7-032
Auto switch mounting bracket/ Quantity	<ul style="list-style-type: none"> • Auto switch mounting bracket x 1 pc. • Auto switch mounting nut x 1 pc. • Hexagon socket head cap screw x 2 pcs. • Hexagon socket head cap screw x 2 pcs. (With spring washer x 2 pcs.)
Auto switch mounting surface	
Mounting of auto switch	<ol style="list-style-type: none"> 1. Attach the auto switch to the auto switch mounting bracket with the hexagon socket head cap screw (M3 x 14 L). The tightening torque for the M3 hexagon socket head cap screw is 0.5 to 0.8 N·m. 2. Fix the auto switch mounting nut and the auto switch mounting bracket temporarily by tightening the hexagon socket head cap screw (M2.5 x 5 L). 3. Insert the temporarily fixed auto switch mounting bracket into the auto switch mounting groove, and slide the auto switch through the auto switch mounting groove. 4. Check the detecting position of the auto switch and fix the auto switch firmly with the hexagon socket head cap screw (M2.5 x 5 L). The tightening torque for the M2.5 hexagon socket head cap screw is 0.2 to 0.3 N·m. 5. If the detecting position is changed, go back to step 3. 

Applicable Cylinder: MGP (With end lock), MGPS (Heavy duty guide rod type)

Auto switch model	Bore size [mm]	
	ø25	ø32 to ø100
D-M9□/M9□V D-M9□W/M9□WV D-M9□A/M9□AV D-A9□/A9□V	BMG2-012	
D-P3DWA	BMG10-025 (With end lock)	
D-P4DW	—	BMG1-040

*: Cylinders with an end lock are available in ø25 to ø100.

*: The heavy duty guide rod type is available in ø50 and ø80.

· For D-A9□(V)/M9□(V)/M9□W(V)/M9□A(V)

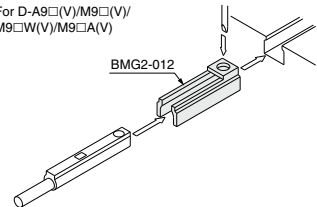

*: Auto switch mounting brackets and auto switches are enclosed with the cylinder for shipment.
For an environment that needs the water-resistant auto switch, select the D-M9□A(V) type.

MGP Series

Made to Order: Individual Specifications



Please contact SMC for detailed dimensions, specifications and lead times.

Symbol

-X144

1 Symmetrical Port Position

Ports are mounted symmetrically.

Applicable Series

Description	Model	Action
Standard type	MGPM-Z	Double acting
	MGPL-Z	Double acting
	MGPA-Z	Double acting

How to Order

MGP ^M_L ^A Standard model no. -X144
 Symmetrical port position ↓

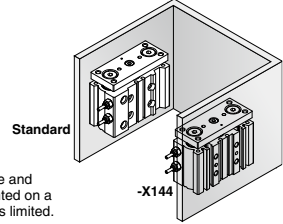

This makes it easy to remove and rotate piping when it is mounted on a wall where mounting space is limited.

Dimensions (Dimensions other than below are the same as standard type.)

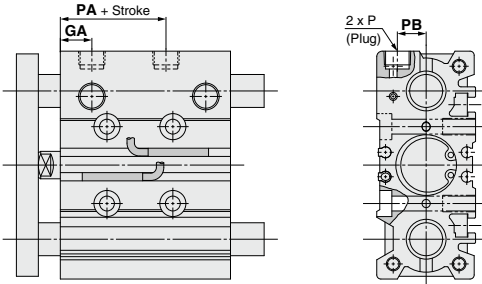

MGPM-Z, MGPL-Z, MGPA-Z Common Dimensions

Bore size [mm]	GA	PA	PB
12	10	13	8
16	10.5	14.5	10
20	11.5	13.5	10.5
25	11.5	12.5	13.5
32	12	6.5	16
40	15	13	18
50	15	9	21.5
63	15.5	13	28
80	19	14.5	25.5
100	22.5	17.5	32.5

2 Side Porting Type (Plug location changed)

Ports on the top plugged in order to use the piping port on the side.

Symbol

-X867

Applicable Series

Description	Model	Action
Standard type	MGPM-Z	Double acting
	MGPL-Z	Double acting
	MGPA-Z	Double acting
With air cushion	MGPM-AZ	Double acting
	MGPL-AZ	Double acting
	MGPA-AZ	Double acting
With end lock	MGPM	Double acting
	MGPL	Double acting
	MGPA	Double acting
Heavy duty guide rod type	MGPS	Double acting

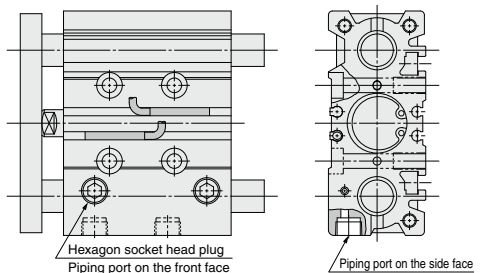

How to Order

MGP ^M_L ^A Standard model no. -X867
 Side porting type (Plug location changed) ↓

3 Enlarged Plate and Body Gap Dimensions

-X471

This specification increases the gap between the plate and body when the cylinder is retracted (Standard: 7 to 16 mm) to 28 to 31 mm.
(Features a safety measure to protect fingers from being caught in the gap)

Applicable series

Description	Model	Action
Standard type	MGPM-Z	Double Acting

Specifications: Same as standard type

How to Order

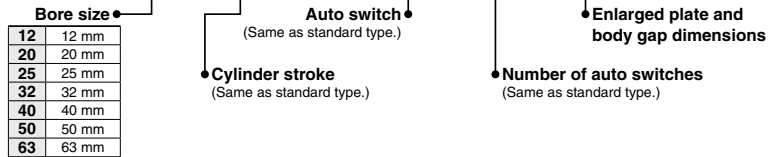
MGPM 32 - 100 Z - M9BW - X471

Dimensions (Dimensions other than below are the same as standard type.)

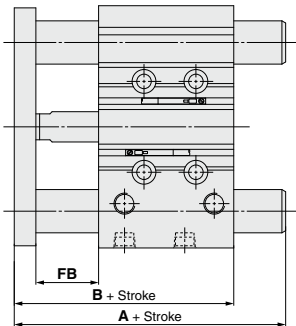

Bore size [mm]	A				B	FB
	50 st or less	Over 50 st 100 st or less	Over 100 st 200 st or less	Over 200 st		
12	64	82.5	104.5	104.5	64	28
16	68	86.5	114.5	114.5	68	28
20	74	98.5	98.5	131	74	29
25	74.5	98.5	98.5	130.5	74.5	28

Bore size [mm]	A			B	FB
	50 st or less	Over 50 st 200 st or less	Over 200 st		
32	92	110.5	146.5	76.5	29
40	92	110.5	146.5	83	29
50	103.5	124.5	165.5	87	31
63	103.5	124.5	165.5	92	31



MGP Series

Specific Product Precautions 1

Be sure to read this before handling the products.
Refer to page 8 for safety instructions and pages 9 to 18 for actuator and auto switch precautions.

Mounting

⚠ Warning

1. **Never place your hands or fingers between the plate and the body.**

Be very careful to prevent your hands or fingers from getting caught in the gap between the cylinder body and the plate when air is applied.

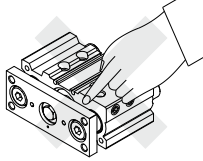

⚠ Caution

1. **Use cylinders within the piston speed range.**

An orifice is set for this cylinder, but the piston speed may exceed the operating range if the speed controller is not used. If the cylinder is used outside the operating speed range, it may cause damage to the cylinder and shorten the service life. Adjust the speed by installing the speed controller and use the cylinder within the limited range.

2. **Pay attention to the operating speed when the product is mounted vertically.**

When using the product in the vertical direction, if the load factor is large, the operating speed can be faster than the control speed of the speed controller (i.e. quick extension). In such cases, it is recommended to use a dual speed controller.

3. **When used near the lower limit of the operating piston speed, stick-slip may occur depending on the operating conditions. To counter this, it is recommended to use an operating pressure with margin.**

4. **Do not use the product if an air leak occurs.**

If an air leak does occur, this may result in the speed being increased beyond the speed controller's adjustment capability, which may further lead to the products speed becoming impossible to control. If the speed is increased excessively, internal components and guide sections may be damaged.

5. **Do not scratch or gouge the sliding portion of the piston rod and the guide rod.**

Damaged seals etc. will result in leakage or malfunction.

6. **Do not dent or scratch the mounting surface of the body and the plate.**

The flatness of the mounting surface may not be maintained, which would cause an increase in sliding resistance.

7. **Make sure that the cylinder mounting surface has a flatness of 0.05 mm or less.**

If the flatness of the workpieces and brackets mounted on the plate is not appropriate, sliding resistance may increase.

If it is difficult to maintain a flatness of 0.05 or less, put a thin shim ring (prepared by user) between the plate and workpiece mounting surface to prevent the sliding resistance from increasing.

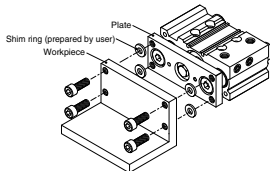

Mounting

⚠ Caution

8. **Be sure that the piston rods are retracted when mounting workpieces on the plate.**

If workpieces are mounted on the plate when the piston rods are extended, it can lead to distortion of the guide unit, resulting in a malfunction.

9. **Bottom of cylinder**

The guide rods protrude from the bottom of the cylinder at the end of the retracting stroke, and therefore, in cases where the cylinder is to be bottom mounted, it is necessary to provide bypass ports in the mounting surface for the guide rods, as well as holes for the hexagon socket head cap screws which are used for mounting.

Moreover, in applications where impact occurs from a stopper etc., the mounting screws should be inserted to a depth of 2d or more.

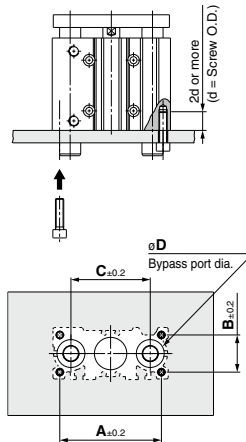

Bore size [mm]	A [mm]	B [mm]	C [mm]	D [mm]		Hexagon socket head cap screw
				MGPM	MGPL/A	
12*	50	18	41	10	8	M4 x 0.7
16	56	22	46	12	10	M5 x 0.8
20	72	24	54	14	12	M5 x 0.8
25	82	30	64	18	15	M6 x 1.0
32	98	34	78	22	18	M8 x 1.25
40	106	40	86	22	18	M8 x 1.25
50	130	46	110	27	22	M10 x 1.5
63	142	58	124	27	22	M10 x 1.5
80	180	54	156	33	28	M12 x 1.75
100	210	62	188	39	33	M14 x 2.0

*: Air cushions are not available for bore size 12.



MGP Series

Specific Product Precautions 2

Be sure to read this before handling the products.
Refer to page 8 for safety instructions and pages 9 to 18 for actuator and auto switch precautions.

Piping

⚠ Caution

Depending on the operating conditions, piping port positions can be changed by using a plug.

1. M5

After tightening by hand, tighten additional 1/6 to 1/4 rotation with a tightening tool.

2. Tapered thread for Rc port (MGP) and NPT port (MGP□□TN)

Tighten with proper tightening torque below. Also, use sealant tape on the plug. With regard to the sunk dimension of a plug ("a" dimension in the drawing), use the stipulated figures as a guide and confirm the air leakage before operation.

* If tightening plugs on the top mounting port with more than the proper tightening torque, plugs will be screwed much deeply and air passage will be squeezed. Consequently, the cylinder speed will be restricted.

Connection thread (plug) size	Proper tightening torque [N·m]	a dimension
1/8	7 to 9	0.5 mm or less
1/4	12 to 14	1 mm or less
3/8	22 to 24	1 mm or less

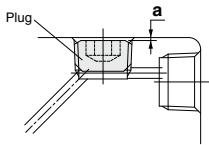

3. Parallel pipe thread for G port (MGP□□TF)

Screw in the plug to the surface of the body (dimension "a" in the drawing) by checking visually instead of using the tightening torque shown in the table.

Cushion

With air cushion

⚠ Warning

1. Do not open the cushion valve excessively.

Air leakage will occur if operated after opening by 4 rotations or more. Furthermore, a stopper mechanism is provided for the cushion valve, and it should not be forced open beyond that position. Be aware that the cushion valve may jump up from the cover when the air is supplied.

⚠ Caution

1. Be sure to use the cylinder after the air cushion has been adjusted appropriately.

First, fully close the cushion valve. Start the operation at the cylinder speed to be used with the load applied, and then open the cushion valve gradually to make the adjustment. The optimal adjustment is that the piston reaches its stroke end and the collision sound is minimized. If the cushion valve is used without adjusting the air cushion appropriately, this may cause damage to the retaining ring or piston.

Bore size [mm]	Applicable tool
16, 20, 25, 32, 40	JIS B4648 hexagon wrench key 1.5
50, 63, 80, 100	JIS B4648 hexagon wrench key 3

2. Be sure to operate a cylinder equipped with air cushion to the end of the stroke.

If it is not operated to the end of the stroke, the effect of the air cushion will not be fully exhibited. Consequently, in cases where the stroke is regulated by an external stopper etc., caution must be exercised, as the air cushion may become completely ineffective.

3. Do not open the cushion needle after rotating it numerous times in a row.

Though uncommon, there are cases in which the cushion needle may leak air.

The cushion needle should be adjusted by gradually opening it while checking the operation of the cylinder cushion.



MGP Series

Specific Product Precautions 3

Be sure to read this before handling the products.
Refer to page 8 for safety instructions and pages 9 to 18 for actuator and auto switch precautions.

Allowable Kinetic Energy

⚠ Caution

Load mass and a maximum speed must be within the ranges shown in the graph below.

MGP with Rubber Bumper

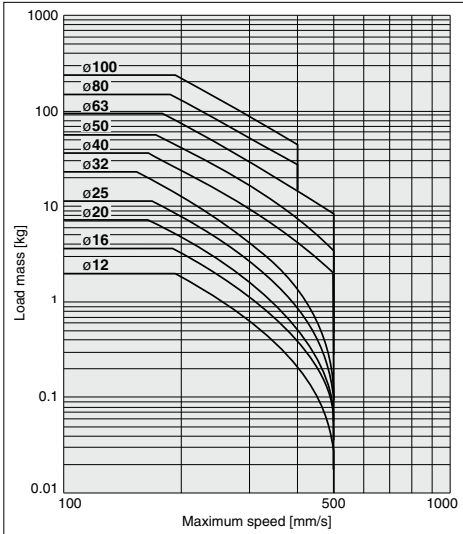

MGP with Air Cushion

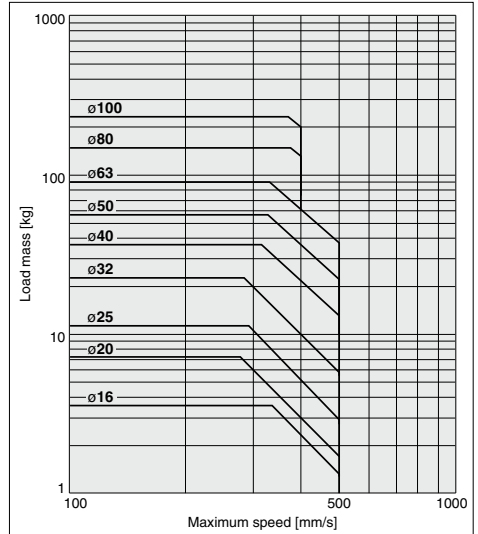

MGP without Cushion (MGP-□V (Water resistant), XB6, XC9, XC22)

