

Escapements

MIW/MIS Series

ø8, ø12, ø20, ø25, ø32

Ideal for separating and feeding individual parts from vibratory feeders, magazines, and hoppers.

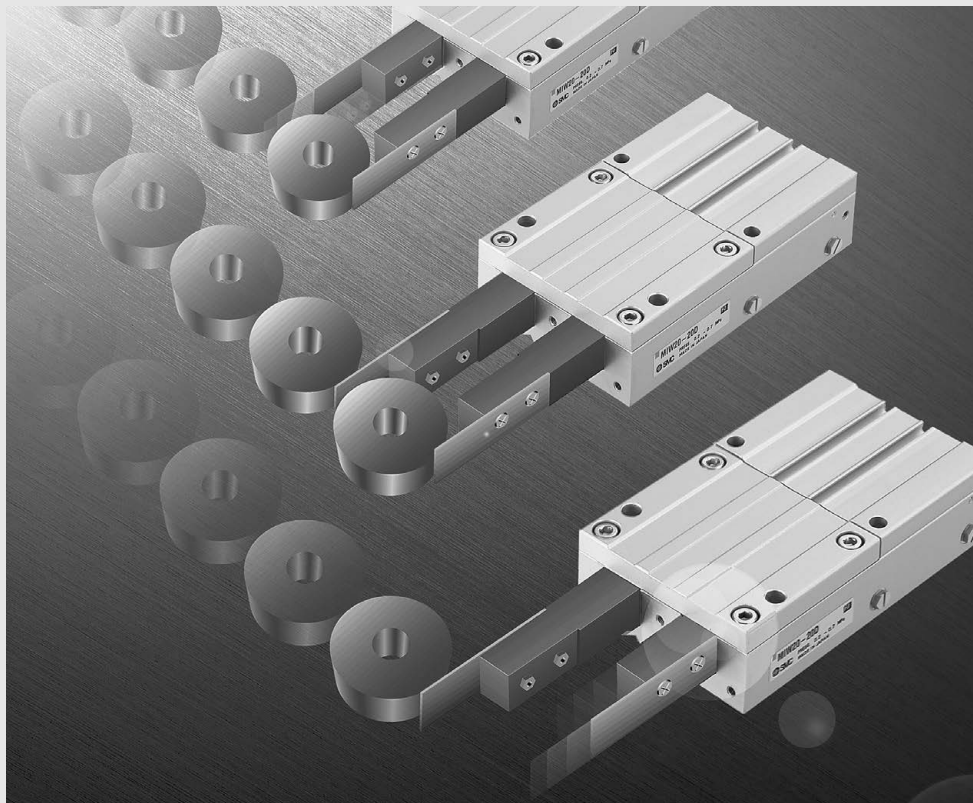

Series variations

Series	Bore size (mm)	Stroke (mm)							Finger option	Stroke adjuster	Scraper
		8	10	12	20	25	30	32			
MIW	8	●							●	●	●
	12			●					●	●	●
	20				●				●	●	●
	25					●			●	●	●
	32							●	●	●	●
MIS	8		●						●	●	●
	12		●	●					●	●	●
	20		●	●	●				●	●	●
	25		●	●	●	●			●	●	●
	32						●	●	●	●	●

Ideal for separating and from vibratory feeders,

Scraper (option)

Optional scraper prevents entry of dust to protect internal components.

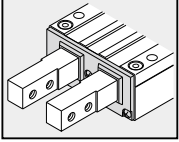

Air passage

Auto switch capable

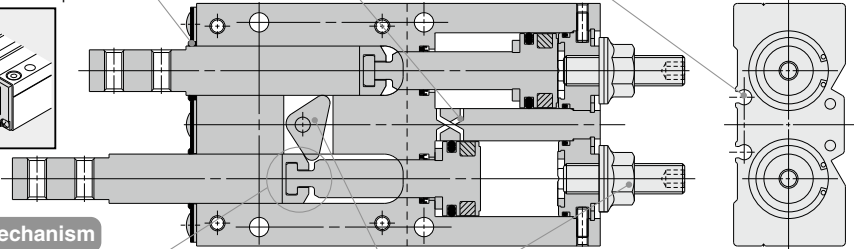

Floating mechanism

Improves life of the escapement by preventing eccentric loads causing damage to the piston and the seals.

As this mechanism separates the fingers from the piston, it is possible to replace the fingers with ease when required.

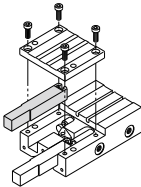

Interlocking

Provides reliable performance of the escapement by interlocking the two piston rods with a cam mechanism and control of air passage to the pistons.

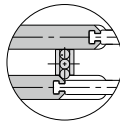

Stroke adjuster (option)

Optional stroke adjuster for precise adjustment of the retracted position of each piston rod.

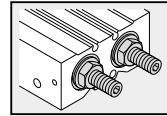

Three variations of fingers

Flexibility in mounting the finger options.

Finger options

Basic type

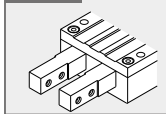

Tapped on upper and lower faces

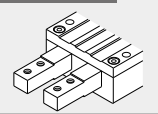

Tapped on all faces

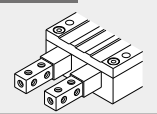

Mounting is possible from 2 directions.

Using through holes from top face

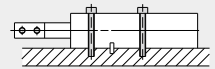

Using tapped holes in the body from bottom face

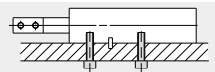

* Positioning pin holes allow for easy mounting.

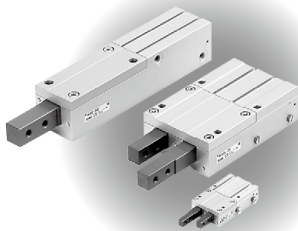

Piping from three directions are possible (Two directions for MIS)

Port position can be adjusted along with setting conditions by changing plug position.

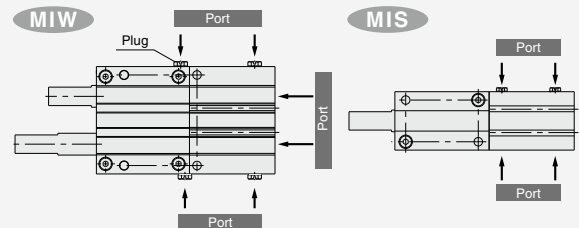

feeding individual parts magazines, and hoppers.

Application examples

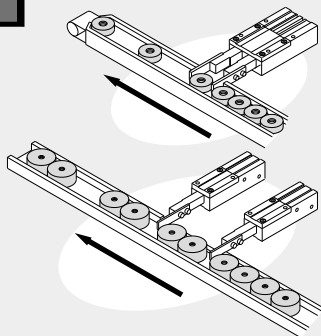

MIW Double finger type

Single valve operation easily separates and feeds each work piece.

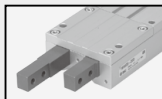

MIS Single finger type

Operating speed and mounting position can be set according to the size of work piece and its operating condition.



Working principle

The cam locks Finger B.

When Finger A is extended to reach the stroke end, air is supplied to retract Finger B.

Extension of Finger A rotates the cam to unlock Finger B and lock finger A to allow retraction of Finger B.

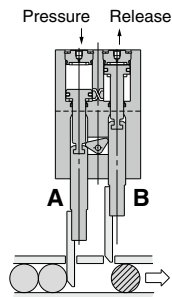
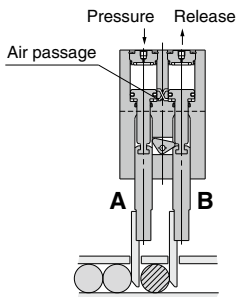
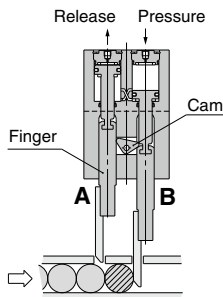

Insertion

Separation

Release

MIW/MIS Series Model Selection

Model Selection

Selection procedure

Procedure 1 Condition confirmation

Procedure 2 Confirmation of impact by work piece

Procedure 3 Confirmation of allowable lateral load

Procedure 1 Confirmation of conditions

● The work piece moves horizontally on the conveyor.

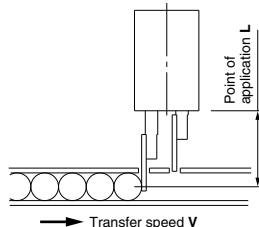

Operation conditions
 Operating pressure P (MPa)
 Workpiece mass m (Kg)
 Workpiece quantity x (Qty.)
 Point of application L (mm)
 Workpiece transfer speed V (m/min)
 Coefficient of friction between the workpiece and conveyor μ

● When the work piece drops vertically from a shooter, etc.

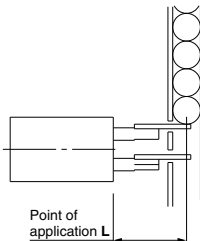

Operation conditions
 Operating pressure P (MPa)
 Workpiece mass m (Kg)
 Workpiece quantity x (Qty.)
 Point of application L (mm)
 Distance of workpiece drop H (mm)
 Gravitational acceleration g (m/s²)

Procedure 2 Confirmation of impact

From the graph of operating range, obtain the point of intersection of the total mass of the workpiece $x \cdot m$ (kg) indicated by the axis of ordinates and the transfer speed V (m/min) indicated by the axis of abscissas. Select a model so that the intersection will fall below the point of application L indicated by a line.

1. Calculation of workpiece collision speed
 The collision speed V is calculated from the distance of work piece fall H.

$$\text{Workpiece collision speed } V = \sqrt{2gH/1000} \times 60 \text{ (m/min)}$$

2. From the graph of operating range, obtain the intersection of the total mass of the workpiece $x \cdot m$ (kg) indicated by the axis of ordinates and the collision speed V (m/min) obtained by calculation. Select a model so that the intersection will fall below the point of application L indicated by a line.

Procedure 3 Confirmation of allowable lateral load

1. Calculation of applied lateral load F
 The lateral load F equals the coefficient between the work piece and the conveyor. Thus, from the total amount of the workpiece and coefficient of friction,

$$F = \mu \cdot x \cdot m \cdot g \text{ (N)}$$

1. Calculation of applied lateral load
 The lateral load F equals the total load of the work piece.
 Thus,
$$F = x \cdot m \cdot g \text{ (N)}$$

2. From the graph of allowable lateral load, obtain the allowable lateral load F max from the intersection of the operating pressure and the point of application L indicated by the axis of abscissas. Select a model so that the value will be larger than the lateral load F applied in real operation.
 Lateral load: $F \leq \text{Allowable lateral load: } F_{\text{max}}$

Model Selection

Operating range

Procedure 1 Confirmation of conditions

- The workpiece moves horizontally on the conveyor.

Operating conditions	
Operating pressure	P = 0.4 MPa
Workpiece mass	m = 0.1 kg
Workpiece quantity	x = 10
Point of application	L = 50 mm
Workpiece transfer speed	V = 12 m/min
Coefficient of friction between the work piece and conveyor $\mu = 0.2$	

- When the workpiece drops vertically from a shooter, etc.

Operating conditions	
Operating pressure	P = 0.4 MPa
Workpiece mass	m = 0.05 kg
Workpiece quantity	x = 5
Point of application	L = 60 mm
Distance of workpiece drop	H = 15 mm
Gravitation acceleration	g = 9.8 m/s ²

Procedure 2 Confirmation of impact

- Obtain the total amount of the workpiece.
Total mass m = 10 x 0.1 (kg) = 1 (kg)
- Obtain the intersection of the transfer speed V and the total weight of workpiece m. Confirm that the value is within the operating range of the point of application L = 50 mm

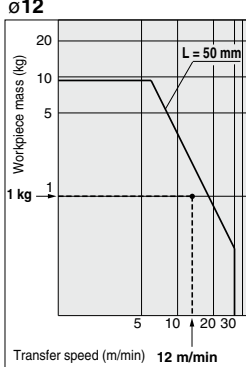

- Obtain the total amount of the workpiece.
Total mass m = 5 x 0.05 (kg) = 0.25 (kg)
- Obtain the collision speed of the workpiece V.
 $V = \sqrt{2gH/1000 \times 60}$
 $= \sqrt{2 \times 9.8 \times 15/1000 \times 60}$
 $= 32.5$ (m/min)

- Obtain the intersection of the collision speed V and the total mass of the workpiece m. Confirm that the value is within the operating range of the point of application L = 60 mm.

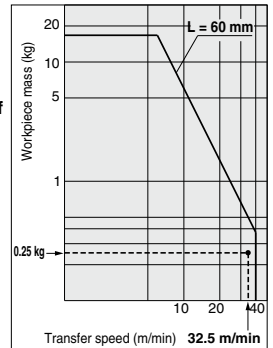

Procedure 3 Confirmation of allowable lateral load

1. Calculation of applied lateral load F
 $F = \mu \cdot N \cdot m \cdot g$ (N)
 $= 0.2 \times 10 \times 0.1 \times 9.8$
 $= 2.1$ (N)

2. Confirmation of allowable lateral load
From the graph, the allowable lateral load at L = 50 mm and P = 0.4 MPa is 18 N.
Because 2.1 N < 18 N, it is applicable.

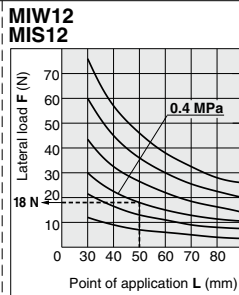

1. Calculation of applied lateral load
The lateral load F equals the total load of the work piece. Thus,
 $F = 5 \times 0.05 \times 9.8$
 $= 2.5$ (N)

2. Confirmation of allowable lateral load
In the same way, the lateral load at L = 50 mm and P = 0.4 MPa is 48 N from the graph. Because 2.5 N < 48 N, it is applicable.

Therefore select MIW (MIS) 12.

Therefore select MIW (MIS) 20.

MIW/MIS Series

Model Selection

Operating range

The graph at right shows conditions of the workpiece to be stopped; that is, the mass, transfer speed and the operating range of the point of application L .

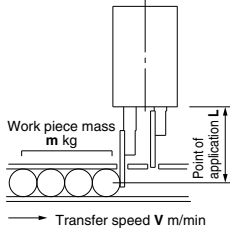

**MIW8
MIS8**

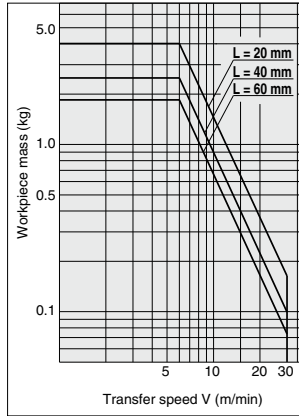

**MIW12
MIS12**

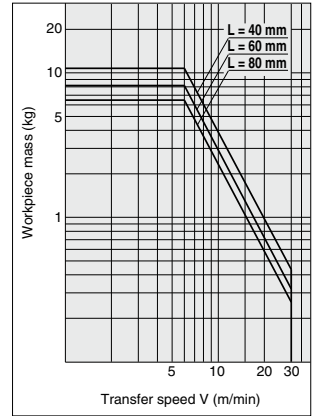

**MIW20
MIS20**

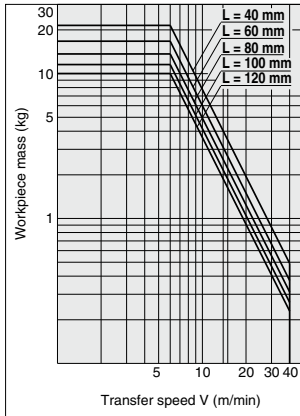

**MIW25
MIS25**

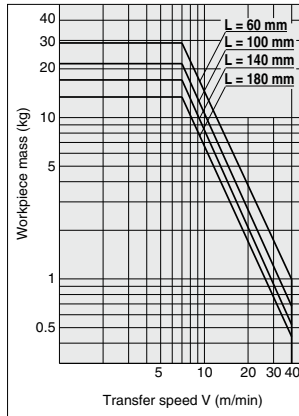

**MIW32
MIS32**

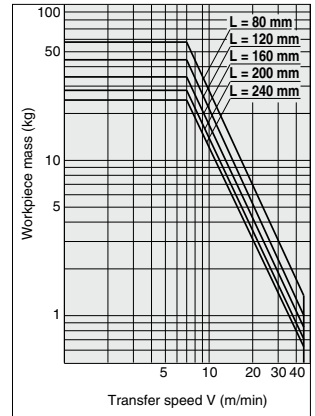

Model Selection

Allowable lateral load

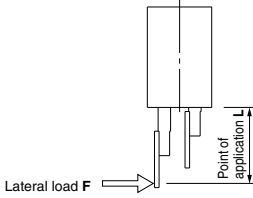

**MIW8
MIS8**

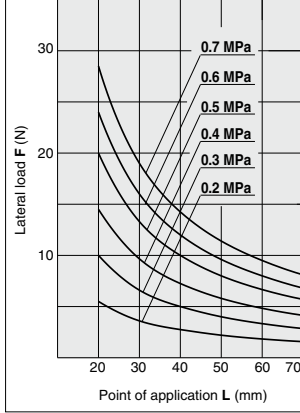

**MIW12
MIS12**

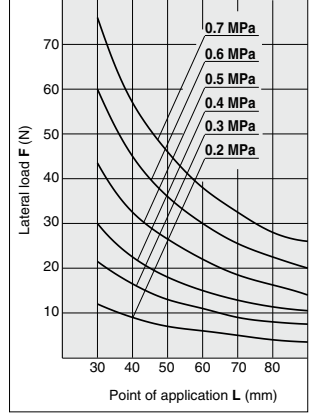

**MIW20
MIS20**

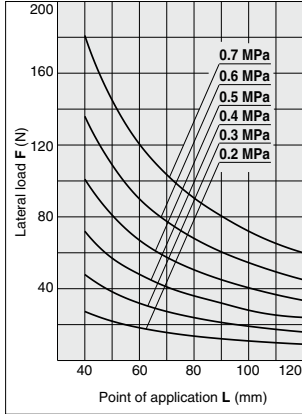

**MIW25
MIS25**

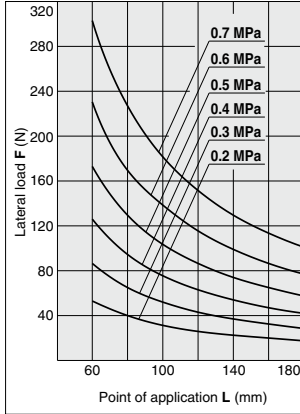

**MIW32
MIS32**

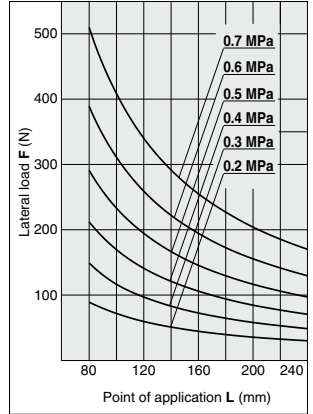

Escapements

MIW/MIS Series

ø8, ø12, ø20, ø25, ø32



How to Order

Double finger type MIW 12 [] - 12 D 1 A S - M9BW [] - []

Single finger type MIS 32 [] - 50 D 1 A S - M9BW [] - []

Finger options

Nil: Basic type (Standard type)

1: Tapped on upper and lower faces

2: Tapped on all faces (5 surfaces including end surface)

Cylinder bore

8	8 mm
12	12 mm
20	20 mm
25	25 mm
32	32 mm

Port thread type

Symbol	Type	Bore size
Nil	M	ø8, ø12
	Rc	ø20, ø25
	NPT	ø32
TN	NPT	ø32
TF	G	

Stroke

* Refer to the next page for standard stroke table.

Scraper

Nil	No
S	Yes

Stroke adjuster

Nil	No
A	Yes

Type of auto switch

Nil	Without auto switch (built-in magnet)
S	1 pc.
	2 pcs.

* Refer to the table below for auto switch part numbers.

Finger options

Nil: Basic type (Standard type)

1: Tapped on upper and lower faces

2: Tapped on all faces (5 surfaces including end surface)

Applicable auto switches/Refer to pages 1341 to 1435 for detailed specifications of auto switches.

Type	Special function	Electrical entry	Indicator light	Wiring (output)	Load voltage		Auto switch models		Lead wire length (m)				Pre-wired connector	Applicable load
					DC	AC	Perpendicular	In-line	0.5 (Nil)	1 (M)	3 (L)	5 (Z)		
Solid state auto switch	—	Grommet	Yes	3-wire (NPN)	24 V	—	M9NV	M9N	●	●	●	○	○	Relay, PLC
				3-wire (PNP)			M9PV	M9P	●	●	●	○	○	
				2-wire	M9BV	M9B	●	●	●	○	○			
	3-wire (NPN)			5 V, 12 V	—	M9NVW	M9NW	●	●	●	○	○		
	3-wire (PNP)					M9PVW	M9PW	●	●	●	○	○		
	2-wire			12 V	—	M9BW	M9B	●	●	●	○	○		
	3-wire (NPN)					M9NAV**	M9NA**	○	○	●	○	○		
	3-wire (PNP)			5 V, 12 V	—	M9PAV**	M9PA**	○	○	●	○	○		
	2-wire					M9BAV**	M9BA**	○	○	●	○	○		
	Water resistant (2-color indicator)													

** Water resistant type auto switches can be mounted on the above models, but in such case SMC cannot guarantee water resistance.

* Lead wire length symbols: 0.5 m Nil (Example) M9NW
 1 m M (Example) M9NW
 3 m L (Example) M9NW
 5 m Z (Example) M9NW

* Solid state auto switches marked with "○" are produced upon receipt of order.

* Refer to pages 1410 and 1411 for the details of auto switches with a pre-wired connector.

* Auto switches are shipped together (not assembled).



Specifications



Series	MIW (Double finger) MIS (Single finger)
Fluid	Air
Operating pressure	0.2 to 0.7 MPa
Ambient temperature and fluid temperature	-10 to 60°C (No freezing)
Lubrication	Non-lube
Action	Double acting
Auto switch (optional) ^{Note)}	Solid state auto switch (3-wire, 2-wire)
Stroke tolerance	$^{+1}_0$ mm

Option

Finger options	Standard, Tapped on upper and lower faces, Tapped on all faces (5 surfaces including end surface)
Stroke adjuster (Rear end stroke only)	MI□8 : Arrangement range 4 mm
	MI□12 : Arrangement range 6 mm
	MI□20 : Arrangement range 12 mm
	MI□25 : Arrangement range 15 mm
	MI□32 : Arrangement range 20 mm
Scraper	Can be mounted on standard products

Theoretical Output

Unit: N

Bore size (mm)	Rod size (mm)	Operating direction	Piston area (mm ²)	Operating pressure MPa					
				0.2	0.3	0.4	0.5	0.6	0.7
8	4	OUT	50	10	15	20	26	31	36
		IN	38	7	11	15	19	23	26
12	6	OUT	113	23	34	45	57	68	79
		IN	85	17	26	34	43	51	60
20	10	OUT	314	63	94	126	157	188	220
		IN	236	47	71	94	118	142	165
25	10	OUT	491	98	147	196	245	295	344
		IN	412	82	124	165	206	247	288
32	12	OUT	804	161	241	322	402	482	563
		IN	691	138	207	276	346	415	484

Standard Stroke

Double finger type/MIW (mm)

Bore size	Stroke
8	8 mm
12	12 mm
20	20 mm
25	25 mm
32	32 mm

* For MIW, same stroke as bore size

Single finger type/MIS (mm)

Bore size	Stroke
8	10, 20 mm
12	10, 20, 30 mm
20	10, 20, 30 mm
25	30, 50 mm
32	30, 50 mm

Made to Order
Individual Specifications
 (For details, refer to page 681.)

Symbol	Specifications
-X4	Heat resistant (-10 to 100°C)
-X5	Fluororubber seal
-X63	Fluorine grease
-X79	Grease for food

Weight

Model	Model	Stroke (mm)	Weight (g)	Increase by stroke adjuster (g)	Increase by scraper (g)
MIW	MIW8-8D	8	110	6	3
	MIW12-12D	12	240	10	5
	MIW20-20D	20	650	30	10
	MIW25-25D	25	1550	30	20
	MIW32-32D	32	2650	100	35
MIS	MIS8-10D	10	62	3	2
	MIS8-20D	20	80		
	MIS12-10D	10	130	5	3
	MIS12-20D	20	160		
	MIS12-30D	30	190		
	MIS20-10D	10	300	15	5
	MIS20-20D	20	355		
	MIS20-30D	30	410		
	MIS25-30D	30	800	15	10
	MIS25-50D	50	1000		
	MIS32-30D	30	1350		
MIS32-50D	50	1650	50	18	

MIW/MIS Series

Construction/Double Finger Type (MIW)

ø8

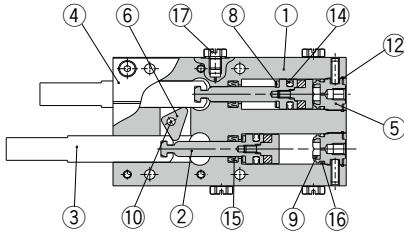

ø12, ø20

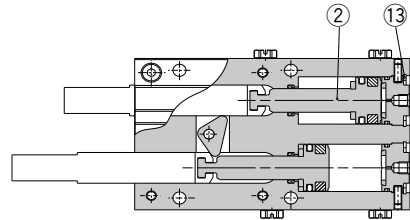

ø25, ø32

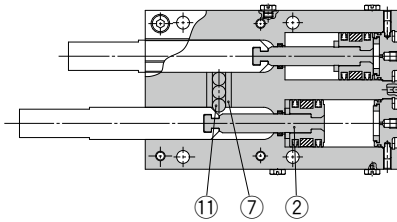

Option

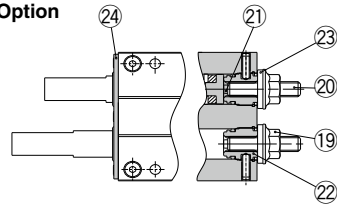

Scraper

Stroke adjuster

(ø32 only)

Component parts

No.	Description	Material	Note
1	Body	Aluminum alloy	Hard anodized
2	Piston assembly		
3	Finger	Carbon steel	Heat treatment/Special treatment
4	Cover	Aluminum alloy	Hard anodized
5	Cap (W)	Aluminum alloy	White anodized
6	Cam	Stainless steel	Heat treatment (MIW8 to 20)
7	Roller holder	Stainless steel	Heat treatment (MIW25, 32)
8	Bumper	Urethane rubber	
9	Head bumper	Urethane rubber	
10	Needle roller	High carbon chromium bearing steel	(MIW8 to 20)

No.	Description	Material	Note
11	Cylinder roller	Carbon steel	(MIW25, 32)
12	Clip	Carbon steel	(MIW8)
13	R shape retaining ring	Carbon steel	(MIW12 to 32)
14	Piston seal	NBR	
15	Rod seal	NBR	
16	Gasket	NBR	
17	Plug		(MIW8 ... M-3P) (MIW12 to 25 ... M-5P)
18	Hexagon socket taper plug		(MIW32 ... Rc1/8)

Option: adjuster

No.	Description	Material	Note
19	Hexagon nut with flange	Carbon steel	Nickel plated
20	Adjustment bolt	Carbon steel	Nickel plated
21	Adjustment bumper	Urethane rubber	
22	Adjustment cap	Aluminum alloy	White anodized
23	Die thread		

Option: scraper

No.	Description	Material	Note
24	Scraper	Stainless steel + NBR	

Replacement parts

Model	Description	Finger			Seal kit	Scraper assembly	Grease pack
		Standard	Tapped on upper and lower faces	Tapped on all faces			
MIW8-8D		MI-A0801-8	MI-A0802-8	MI-A0803-8	MIW8-PS	MIW-A0804	MH-G01 (contents quantity 30 g)
MIW12-12D		MI-A1201-12	MI-A1202-12	MI-A1203-12	MIW12-PS	MIW-A1204	
MIW20-20D		MI-A2001-20	MI-A2002-20	MI-A2003-20	MIW20-PS	MIW-A2004	
MIW25-25D		MI-A2501-25	MI-A2502-25	MI-A2503-25	MIW25-PS	MIW-A2504	
MIW32-32D		MI-A3201-32	MI-A3202-32	MI-A3203-32	MIW32-PS	MIW-A3204	
Main parts No.		③ (1 pc.)			⑭, ⑮, ⑯	⑳	

Construction/Single Finger Type (MIS)

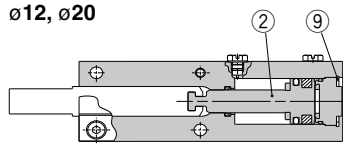
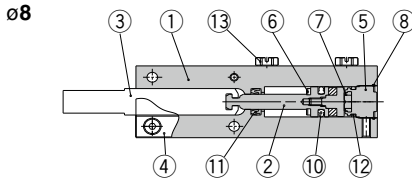

ø25, ø32

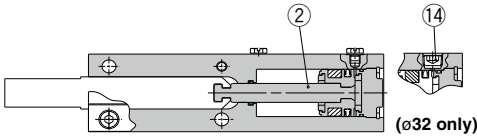

Option

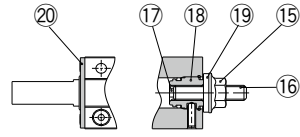

Scraper

Stroke adjuster

Component parts

No.	Description	Material	Note
1	Body	Aluminum alloy	Hard anodized
2	Piston assembly		
3	Finger	Carbon steel	Heat treatment/Special treatment
4	Cover	Aluminum alloy	Hard anodized
5	Cap (S)	Aluminum alloy	White anodized
6	Bumper	Urethane rubber	
7	Head bumper	Urethane rubber	
8	Clip	Carbon steel	(MIS8)
9	R shape retaining ring	Carbon steel	(MIS12 to 32)

No.	Description	Material	Note
10	Piston seal	NBR	
11	Rod seal	NBR	
12	Gasket	NBR	
13	Plug		(MIS8 ... M-3P) (MIS12 to 25 ... M-5P)
14	Hexagon socket taper plug		(MIS32 ... Rc1/8)

Option: adjuster

No.	Description	Material	Note
15	Hexagon nut with flange	Carbon steel	Nickel plated
16	Adjustment bolt	Carbon steel	Nickel plated
17	Adjustment bumper	Urethane rubber	
18	Adjustment cap	Aluminum alloy	White anodized
19	Die thread		

Option: scraper

No.	Description	Material	Note
20	Scraper	Stainless steel + NBR	

Replacement parts

Model	Description			Seal kit	Scraper assembly	Grease pack
	Standard	Finger				
		Tapped on upper and lower faces	Tapped on all faces			
MIS8-10D	MI-A0801-10	MI-A0802-10	MI-A0803-10	MIS8-PS	MIS-A0804	MH-G01 (contents quantity 30 g)
MIS8-20D	MI-A0801-20	MI-A0802-20	MI-A0803-20			
MIS12-10D	MI-A1201-10	MI-A1202-10	MI-A1203-10			
MIS12-20D	MI-A1201-20	MI-A1202-20	MI-A1203-20	MIS12-PS	MIS-A1204	
MIS12-30D	MI-A1201-30	MI-A1202-30	MI-A1203-30			
MIS20-10D	MI-A2001-10	MI-A2002-10	MI-A2003-10			
MIS20-20D	MI-A2001-20	MI-A2002-20	MI-A2003-20	MIS20-PS	MIS-A2004	
MIS20-30D	MI-A2001-30	MI-A2002-30	MI-A2003-30			
MIS25-30D	MI-A2501-30	MI-A2502-30	MI-A2503-30			
MIS25-50D	MI-A2501-50	MI-A2502-50	MI-A2503-50	MIS25-PS	MIS-A2504	
MIS32-30D	MI-A3201-30	MI-A3202-30	MI-A3203-30			
MIS32-50D	MI-A3201-50	MI-A3202-50	MI-A3203-50			
Main parts No.	③ (1 pc.)			⑩, ⑪, ⑫	⑳	

MIW/MIS Series

Dimensions/Double Finger Type

MIW□-□D

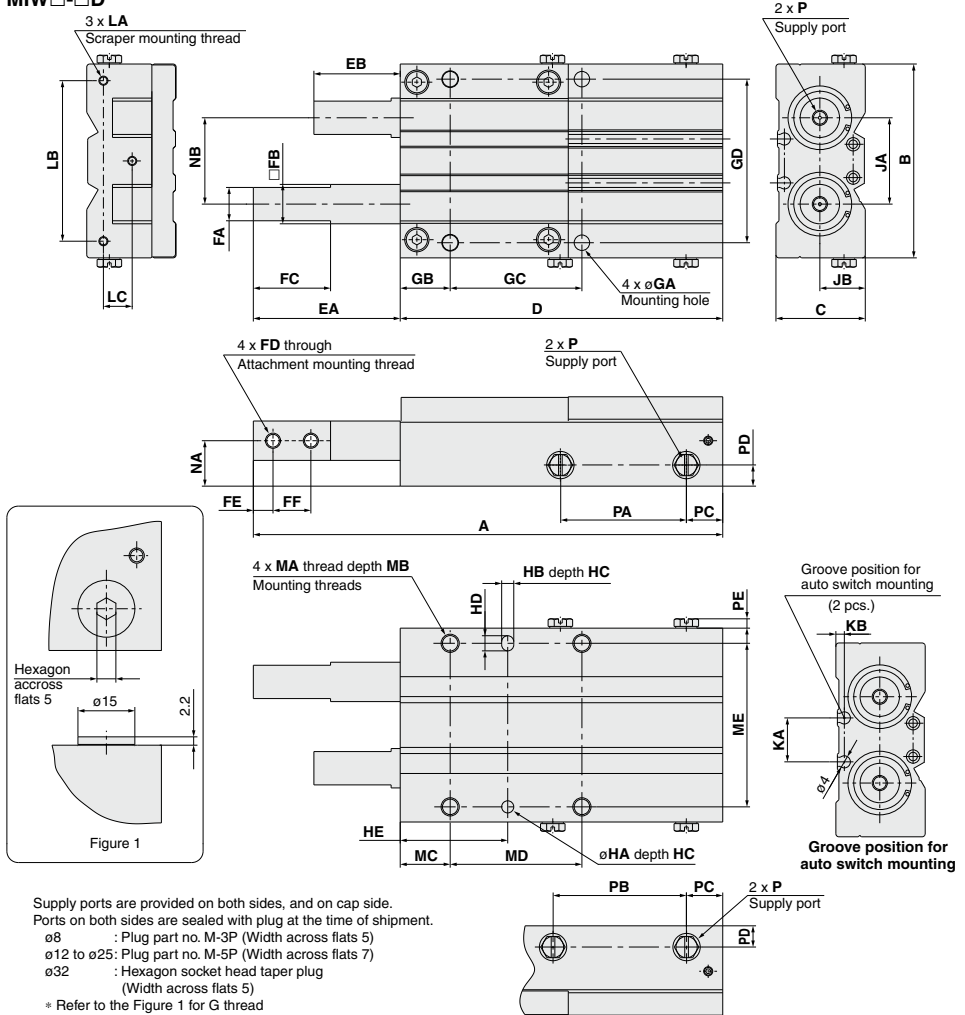

Model	A	B	C	D	EA	EB	FA	FB	FC	FD	FE	FF	FG	GA	GB	GC	GD
MIW8-8	83	34	16	57	26	18	6 ^{+0.1} _{-0.1}	7h9 ^{+0.036} _{-0.036}	15	M3 x 0.5	4	7	6 (Effective depth 2.5)	2.6	9	22	28
MIW12-12	111	44	21	76	35	23	8 ^{+0.1} _{-0.1}	10h9 ^{+0.036} _{-0.036}	19	M3 x 0.5	4.5	9.5	6 (Effective depth 3)	3.3	12.5	34	37
MIW20-20	155	64	29.5	106.5	48.5	28.5	11 ^{+0.1} _{-0.1}	13h9 ^{+0.043} _{-0.043}	25.5	M5 x 0.8	6.5	12.5	10 (Effective depth 4)	5.1	16.5	43.5	54
MIW25-25	200	84	40	134	66	41	15 ^{+0.1} _{-0.1}	17h9 ^{+0.043} _{-0.043}	37	M6 x 1	10	17	15 (Effective depth 7)	6.8	20	58	71
MIW32-32	256	95	47	169	87	55	19.5 ^{+0.1} _{-0.1}	21h9 ^{+0.052} _{-0.052}	51	M8 x 1.25	12.5	22	17 (Effective depth 8.5)	8.6	24.5	73	80

Model	HA, HB	HC	HD	HE	JA	JB	KA	KB	LA	LB
MIW8-8	2H9 ^{+0.025} _{-0.025}	2	3	15	14.5	7.5	20.3	1.6	M2 x 0.4	28.4
MIW12-12	2.5H9 ^{+0.025} _{-0.025}	4	3.5	25	19	11	7.6	2.2	M2.6 x 0.45	37
MIW20-20	4H9 ^{+0.030} _{-0.030}	5	5	35.5	28.5	15	14.5	2.8	M3 x 0.5	53
MIW25-25	5H9 ^{+0.030} _{-0.030}	5	7	40	35.5	20	24.5	3	M3 x 0.5	70
MIW32-32	6H9 ^{+0.030} _{-0.030}	6	8	50	44.5	25	24.1	2.5	M4 x 0.7	81

Finger options

Tapped on upper and lower faces

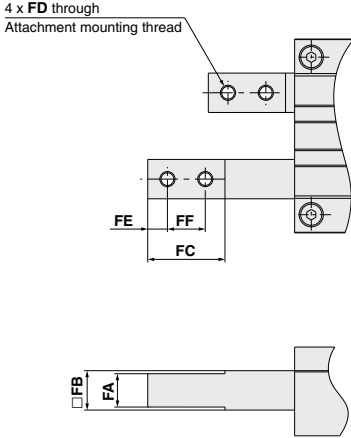

Tapped on all faces

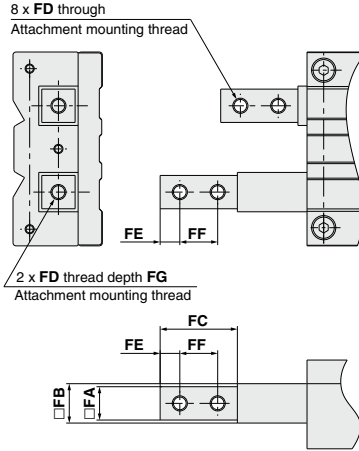

Stroke adjuster

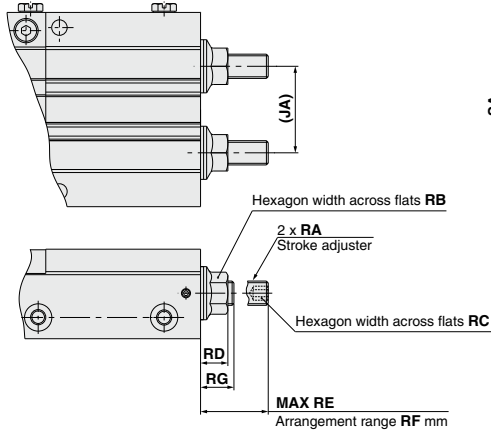

Scraper

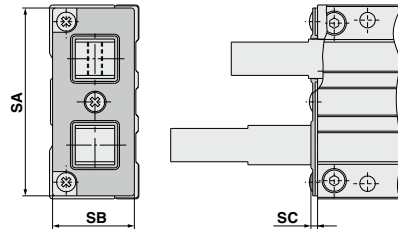

Note) Observe the specified adjustment range when adjusting with a stroke adjuster.

Model	LC	MA	MB	MC	MD	ME	NA	NB	P	PA	PB	PC	PD	PE	RA	RB	RC	RD
MIW8-8	4.5	M3 x 0.5	6	9	22	28	7.5	14.5	M3 x 0.5	22.5	24	8	4.5	2.2	M4 x 0.7	7	2	5.7
MIW12-12	7.5	M4 x 0.7	7	12.5	34	37	11	19	M5 x 0.8	25	27	10	6	2.8	M5 x 0.8	8	2.5	6
MIW20-20	9.5	M6 x 1	10	16.5	43.5	54	15	28.5	M5 x 0.8	41.5	44	12	7	2.7	M8 x 1	12	4	9
MIW25-25	12	M8 x 1.25	12	20	58	71	20	35.5	M5 x 0.8	50	55	14	8.5	2.7	M8 x 1	12	4	9
MIW32-32	16.5	M10 x 1.5	15	24.5	73	80	25	44.5	Rc1/8	69.5	75.5	14.5	11	—	M12 x 1.25	17	6	12.4

Model	RE	RF	RG	SA	SB	SC
MIW8-8	12.5	4	8.5	33	14.5	1.4
MIW12-12	14	6	8	43	18.5	1.8
MIW20-20	22.5	12	10.5	62	27	2.2
MIW25-25	26	15	11	81	35	2.8
MIW32-32	33	20	13	93	42	3.4

MIW/MIS Series

Dimensions/Single Finger Type

MIS□-□D

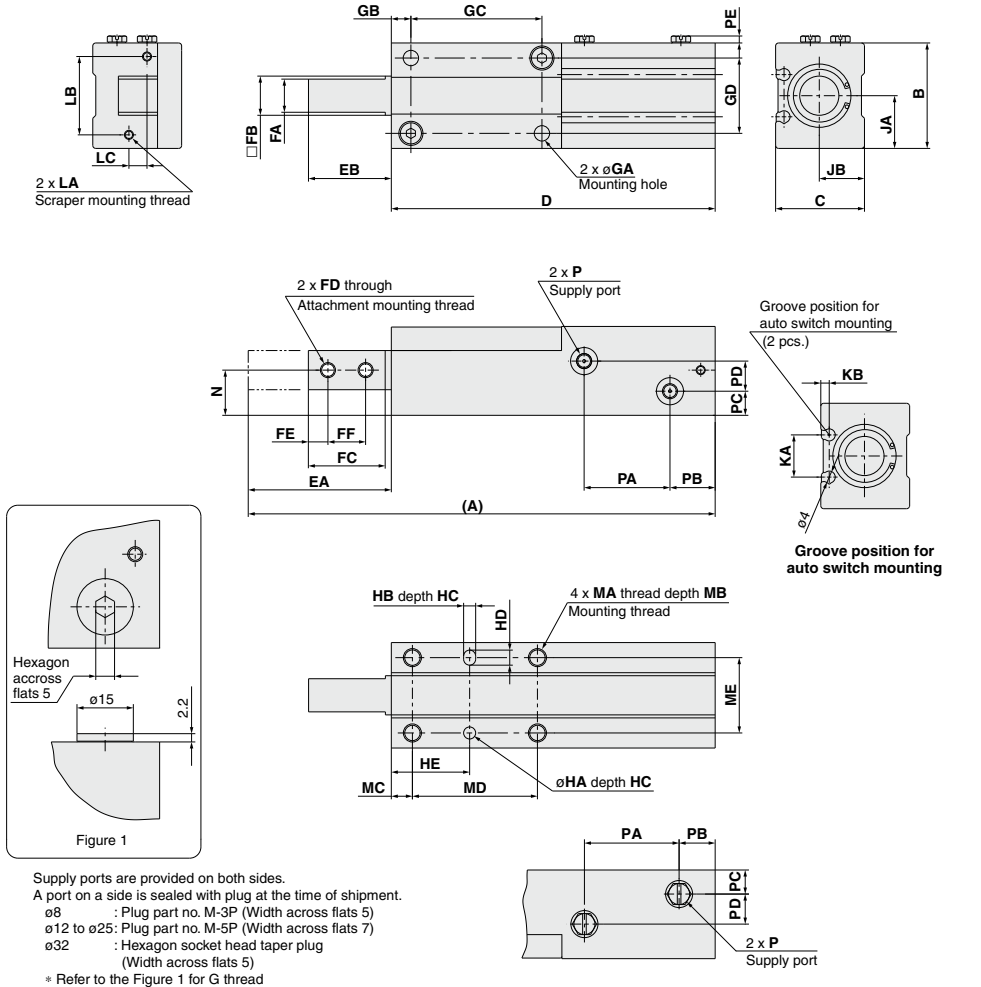

Model	A	B	C	D	EA	EB	FA	FB	FC	FD	FE	FF	FG	GA	GB	GC	GD	HA, HB
MIS8-10	87	19	16	59	28	18	6 ^{+0.1}	7h9 ^{+0.008}	15	M3 x 0.5	4	7	6 (Effective depth 2.5)	2.6	4	20	13	2H9 ^{+0.025}
MIS8-20	117			79	38											30		
MIS12-10	105	26	21	72	33	23	8 ^{+0.1}	10h9 ^{+0.008}	19	M3 x 0.5	4.5	9.5	6 (Effective depth 3)	3.3	5	28	18	2.5H9 ^{+0.025}
MIS12-20	135			92	43											38		
MIS12-30	165			112	53											48		
MIS20-10	125	35	29.5	86.5	38.5	28.5	11 ^{+0.1}	13h9 ^{+0.043}	25.5	M5 x 0.8	6.5	12.5	10 (Effective depth 4)	5.1	7	32	25	4H9 ^{+0.020}
MIS20-20	155			106.5	48.5											42		
MIS20-30	185			126.5	58.5											52		
MIS25-30	215	41	40	144	71	41	15 ^{+0.1}	17h9 ^{+0.043}	37	M6 x 1	10	17	15 (Effective depth 7)	6.8	10	55	28	5H9 ^{+0.020}
MIS25-50	275			184	91											75		
MIS32-30	250	50	47	165	85	55	19.5 ^{+0.1}	21h9 ^{+0.052}	51	M8 x 1.25	12.5	22	17 (Effective depth 8.5)	8.6	12	64	34	6H9 ^{+0.020}
MIS32-50	310			205	105											84		

Finger options
Tapped on upper and lower faces

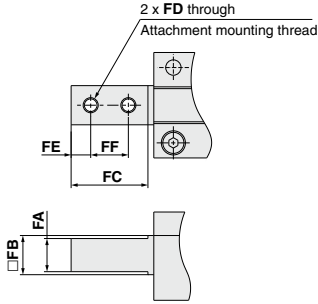

Tapped on all faces

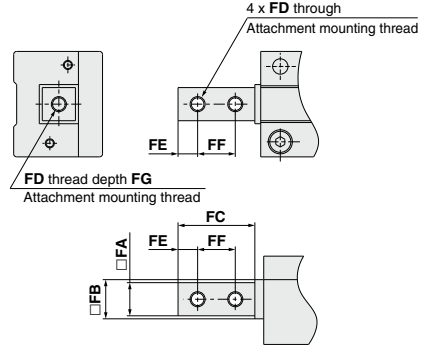

With adjuster

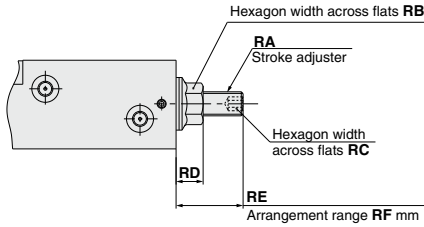

With scraper

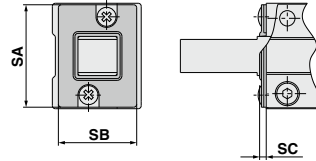

Note) Observe the specified adjustment range when adjusting with a stroke adjuster.

Model	HC	HD	HE	JA	JB	KA	KB	LA	LB	LC	MA	MB	MC	MD	ME	N	P	PA	PB	PC
MIS8-10	2	3	14	9.5	7.5	6.2	1.6	M2 x 0.4	14	3	M3 x 0.5	5	4	20	13	7.5	M3 x 0.5	19	8	4.5
MIS8-20														30				29		
MIS12-10														28				19		
MIS12-20	4	3.5	17.5	13	11	11.6	2.2	M2.6 x 0.45	19	4	M4 x 0.7	7	5	38	18	11	M5 x 0.8	29	10	6
MIS12-30														48				39		
MIS20-10														32				20.5		
MIS20-20	5	5	26	17.5	15	14	2.8	M3 x 0.5	26	6	M6 x 1	10	7	42	25	15	M5 x 0.8	30.5	12	8
MIS20-30														52				40.5		
MIS25-30	5	7	32	20.5	20	11	3	M3 x 0.5	32	10	M8 x 1.25	14	10	55	28	20	M5 x 0.8	47	14	12
MIS25-50														75				67		
MIS32-30	6	8	40	25	25	20.4	2.5	M4 x 0.7	39	12	M10 x 1.5	15	12	64	34	25	Rc1/8	47	14.5	11
MIS32-50														84				67		

Model	PD	PE	RA	RB	RC	RD	RE	RF	SA	SB	SC
MIS8-10	6	2.2	M4 x 0.7	7	2	5.7	12.5	4	18.6	14	1.4
MIS8-20											
MIS12-10											
MIS12-20	7	3	M5 x 0.8	8	2.5	6	14	6	24	18	1.8
MIS12-30											
MIS20-10											
MIS20-20	10	3	M8 x 1	12	4	9	22.5	12	34	26	2.2
MIS20-30											
MIS25-30	14	2.7	M8 x 1	12	4	9	26	15	40	36	2.8
MIS25-50											
MIS32-30	27	—	M12 x 1.25	17	6	12.4	33	20	49	41	3.4
MIS32-50											

MIW/MIS Series Auto Switch Mounting

Auto Switch Mounting

When mounting an auto switch, insert the auto switch in the switch mounting groove on the escapement from the direction as below figure. Having set the mounting position, tighten the attached auto switch mounting screws with a flat head watchmaker's screwdriver.

* When adjusting the auto switch mounting screws, use a watchmaker's screwdriver with a handle 5 to 6 mm in diameter. (This is to prevent fracture due to an excessive torque.) Also, tighten with a torque of about 0.05 to 0.15 N·m, or about 0.05 to 0.10 N·m for D-M9□A(V).

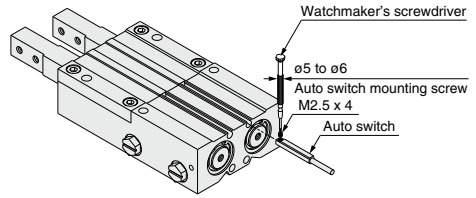

Proper mounting position for stroke end detection

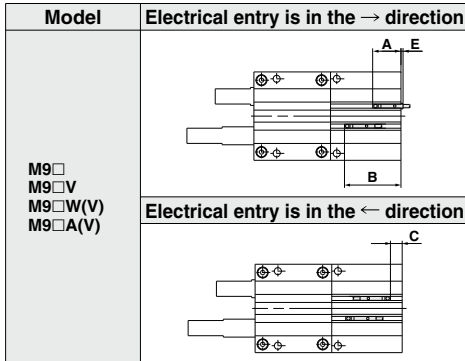

Auto Switch Operating Range

MIW	(mm)				
Auto switch model	ø8	ø12	ø20	ø25	ø32
D-M9□(V)					
D-M9□W(V)	3	2.5	4	5.5	7
D-M9□A(V)					

MIS	(mm)				
Auto switch model	ø8	ø12	ø20	ø25	ø32
D-M9□(V)					
D-M9□W(V)	3	3.5	4.5	5.5	7
D-M9□A(V)					

Note) The operating ranges are provided as guidelines including hysteresis and are not guaranteed values (with ±30% variations). Hysteresis may fluctuate due to the operating environments.

Model	Proper mounting position		Model	Proper mounting position		Model	Proper mounting position	
	D-M9□ D-M9□W D-M9□A	D-M9□V D-M9□WV D-M9□AV		D-M9□ D-M9□W D-M9□A	D-M9□V D-M9□WV D-M9□AV		D-M9□ D-M9□W D-M9□A	D-M9□V D-M9□WV D-M9□AV
MIW8-8D	A	16.5	MIS12-30D	A	18.5	MIS25-30D	A	7.5
	B	25		B	49		B	38
	C	4.5		C	6.5		C	21
	D	—		D	—		D	—
	E	6 4		E	3.5 1.5		E	— —
MIS8-10D	A	16.5	MIW20-20D	A	20.5	MIS25-50D	A	7.5
	B	27		B	41		B	38
	C	4.5		C	8.5		C	21
	D	—		D	—		D	—
	E	6 4		E	4 2		E	— —
MIS8-20D	A	16.5	MIS20-10D	A	20.5	MIW32-32D	A	8.5
	B	37		B	31		B	41
	C	4.5		C	8.5		C	29
	D	—		D	—		D	—
	E	6 4		E	4 2		E	— —
MIW12-12D	A	18.5	MIS20-20D	A	20.5	MIS32-30D	A	8.5
	B	31		B	51		B	39
	C	6.5		C	8.5		C	29
	D	—		D	—		D	—
	E	3.5 1.5		E	4 2		E	— —
MIS12-10D	A	18.5	MIS20-30D	A	20.5	MIS32-50D	A	8.5
	B	29		B	61		B	59
	C	6.5		C	8.5		C	29
	D	—		D	—		D	—
	E	3.5 1.5		E	4 2		E	— —
MIS12-20D	A	18.5	MIW25-25D	A	7.5			
	B	39		B	33			
	C	6.5		C	21			
	D	—		D	—			
	E	3.5 1.5		E	— —			

Note) Adjust the auto switch after confirming the operating conditions in the actual setting.



1 Heat Resistant (-10 to 100°C)

Symbol

-X4

Change seal material and greases, so that it can be used at an ambient temperature range from -10 °C to up to 100 °C.

How to Order

MIW - **X4**

● Heat resistant

Note) Magnets are built-in, but the applicable ambient temperature is from -10 °C to 60 °C when auto switches are used.

Specifications

Ambient temperature range	-10°C to 100°C
Seal material	Fluororubber
Grease	Heat resistant grease (GR-F)
Bore size (mm)	8, 12, 20, 25, 32

* Dimensions other than the above is the same as the standard type.

Warning

Precautions

Be aware that smoking cigarettes etc. after your hands have come into contact with the grease used in this cylinder can create a gas that is hazardous to humans.

2 Fluororubber Seal

Symbol

-X5

How to Order

MIW - **X5**

● Fluororubber seal

Note) Since the same magnets as for the standard type are built-in, contact SMC for the product adaptability to the operating environment before handling.

Specifications

Seal material	Fluororubber
Bore size (mm)	8, 12, 20, 25, 32

* Dimensions other than the above is the same as the standard type.

3 Fluorine Grease

Symbol

-X63

How to Order

MIW - **X63**

● Fluorine grease

Warning

Precautions

Be aware that smoking cigarettes etc. after your hands have come into contact with the grease used in this cylinder can create a gas that is hazardous to humans.

Specifications

Grease	PTFE grease (GR-F)
Bore size (mm)	8, 12, 20, 25, 32

* Dimensions other than the above is the same as the standard type.

MIW/MIS Series

Made to Order: Individual Specifications

Please contact SMC for detailed dimensions, specifications and lead times.



4 Grease for Food Processing Equipment

Symbol
-X79

Food grade grease (certified by NSF-H1)/Fluorine grease are used as lubricant.

How to Order

MIW MIS **Standard model no. -X79**

● Grease for food processing equipment

Specifications

Grease	Grease for food processing equipment/ Fluorine grease
Bore size (mm)	8, 12, 20, 25, 32

* Specifications and external dimensions other than above are the same as standard type.

Warning

Precautions

Be aware that smoking cigarettes etc. after your hands have come into contact with the grease used in this cylinder can create a gas that is hazardous to humans.

<Not installable>

Food zone.....An environment where food which will be sold as merchandize, directly touches the cylinder's components.

Splash zone.....An environment where food which will not be sold as merchandize, directly touches the cylinder's components.

<Installable>

Non-food zone.....An environment where there is no contact with food.

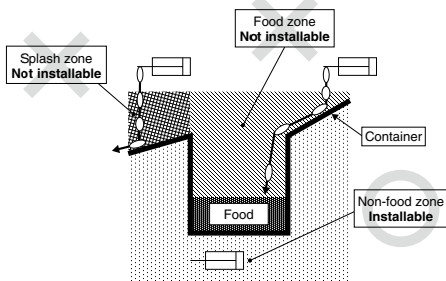

- Note 1) Avoid using this product in the food zone. (Refer to the figure above.)
- Note 2) Operate without lubrication from a pneumatic system lubricator.
- Note 3) Use the following grease pack for the maintenance work.
GR-H-010 (Grease: 10 g)
- Note 4) Please contact SMC for details on the maintenance intervals for this cylinder, which differ from those of the standard cylinder.



MIW/MIS Series

Specific Product Precautions 1

Be sure to read this before handling the products.

Refer to page 9 for safety instructions and pages 10 to 19 for actuator and auto switch precautions.ns.

Selection

⚠ Warning

1. Design the attachment to be light and short.

- 1) A long and heavy attachment can cause a large inertia force in operation, sometimes affecting the life time.
- 2) Design the attachment to be as short and light as possible even within the limitation.

Mounting

⚠ Warning

1. Do not scratch or gouge the escapement by dropping or bumping it when mounting.

Even a slight deformation can cause inaccuracy or malfunction.

2. Please observe the specified torque limits when tightening screws to mount the attachment.

A tightening torque beyond the specified limits can cause malfunction, while a tightening torque below the specified limits can cause dislocation or drop off.

Mounting attachment on finger

When mounting an attachment on the finger, support the finger with a tool like a spanner to prevent twisting. Mount attachments by inserting bolts, etc. into the female mounting threads on the fingers and tightening with the torque shown in the table below.

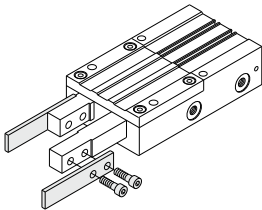

Model	Bolt	Max tightening torque (N·m)
MIW8	M3 x 0.5	0.88
MIS8		
MIW12	M3 x 0.5	0.88
MIS12		
MIW20	M5 x 0.8	4.3
MIS20		
MIW25	M6 x 1	7.3
MIS25		
MIW32	M8 x 1.25	17.5
MIS32		

3. Please observe the specified torque limits when tightening screws to mount the attachment.

A tightening torque above the specified limits can cause malfunction, while a tightening torque below the specified limits can cause dislocation or drop off.

Mounting

Mounting

Body tap

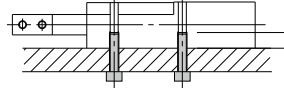

Model	Bolt	Max tightening torque (N·m)	Max screw-in depth (mm)
MIW8	M3 x 0.5	0.88	6
MIS8		0.63	4.5
MIW12	M4 x 0.7	1.5	6
MIS12			
MIW20	M6 x 1	5.2	9
MIS20			
MIW25	M8 x 1.25	12.5	12
MIS25			
MIW32	M10 x 1.5	24.5	15
MIS32			

Body through hole

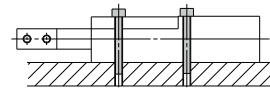

Model	Bolt	Max tightening torque (N·m)
MIW8	M2.5 x 0.45	0.5
MIS8		
MIW12	M3 x 0.5	0.88
MIS12		
MIW20	M5 x 0.8	4.3
MIS20		
MIW25	M6 x 1	7.3
MIS25		
MIW32	M8 x 1.25	17.5
MIS32		

⚠ Caution

1. When mounting an attachment on the finger, support the finger with a tool like a spanner to prevent twisting.

Otherwise malfunction may result.

2. Please do not scratch or gouge the sliding part of the finger.

It may increase the sliding resistance or cause abrasion.

3. Use a speed controller, etc. to keep the operating speed of the finger within the proper range.

Otherwise the life time may be adversely affected by inertia force of the attachment.

4. Conduct meter-out control to throttle down the speed.

Applicable speed controller

- Direct connection type – AS120□ Piping type – AS1001F
 Direct connection type – AS220□ Piping type – AS2001F etc.



MIW/MIS Series

Specific Product Precautions 2

Be sure to read this before handling the products.

Refer to page 9 for safety instructions and pages 10 to 19 for actuator and auto switch precautions.

Changing of Piping Directions

⚠ Caution

1. Please observe the specified torque limits when tightening a plug to change the piping directions.

A tightening torque above the specified limits can cause a damage to the plug, while tightening torque below the specified limits can cause a damage to seal or the screw come loose during the operation.

Model	Port size	How to tight
MIW8 MIS8	M3 x 0.5 (Plug part no.: M-3P)	Turn another 1/4 turn with a tool after manual tightening.
MIW12 MIS12	M5 x 0.8 (Plug part no.: M-5P)	Turn another 1/6 turn with a tool after manual tightening.
MIW20 MIS20		
MIW25 MIS25		
MIW32 MIS32	Rc1/8	Tightening torque 7 to 9 N·m

Supply port operation

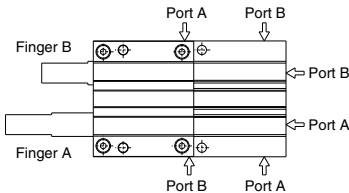

Pressured from A port → Finger A extends, finger B retracts

Pressure from B port → Finger B extends, finger A retracts

Handling of Adjuster Options

Stroke adjuster

⚠ Warning

1. Observe the specified adjustment range as shown on right when adjusting with a stroke adjuster.

Bolts may shoot out when adjusting stroke adjuster over the maximum stroke as shown on right. Be sure to observe the specified adjustment range, otherwise malfunction may results.

Handling of Adjuster Options

⚠ Warning

Model	At the maximum stroke (mm)	At the maximum adjustment (mm)	Adjustment range (mm)
MIW8	12.5	8.4	4
MIS8			
MIW12	14	8	6
MIS12			
MIW20	22.5	10.5	12
MIS20			
MIW25	26	11	15
MIS25			
MIW32	33	13	20
MIS32			

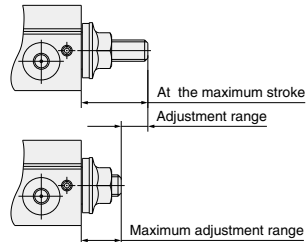

2. Be sure to use specified adjuster bolts for replacement. Otherwise, fracture may be caused by an impact etc.

3. Refer to the table below for the lock nut tightening torque.

Insufficient tightening can cause air leakage.

Model	Tightening torque (N·m)
MIW8	1.2 to 1.5
MIS8	
MIW12	2.5 to 3.0
MIS12	
MIW20	10.5 to 12.5
MIS20	
MIW25	10.5 to 12.5
MIS25	
MIW32	34 to 42
MIS32	

Operating Environment

⚠ Caution

1. Do not use in an environment where the product is directly exposed to liquid such as cutting lubricant.

Avoid use in an environment where the product is exposed to cutting lubricant, liquid coolant or oil mist. It can cause rattles, increase in sliding resistance and air leakage.

2. Do not use in an environment where the product is directly exposed to foreign matter such as dust, coarse particulate, chips and polishing powder from a spatter grinder, etc.

It can cause rattles, increase in sliding resistance and air leakage.



MIW/MIS Series

Specific Product Precautions 3

Be sure to read this before handling the products.

Refer to page 9 for safety instructions and pages 10 to 19 for actuator and auto switch precautions.

Operating Environment

⚠ Caution

3. Provide shading in an environment where the product is exposed to the sunlight.

4. Block off heat radiation in an environment where a heat source is at a close distance.

Block off heat radiation with a cover if a heat source is at a close distance because the temperature of the product can rise to exceed the operating temperature range due to radiation.

5. Do not use in an environment where vibration or impact occurs.

Contact SMC about use under such conditions because it can cause fracture or malfunction.

Lubrication

⚠ Caution

1. The non-lubricant type escapement is lubricated at the factory and does not need further lubrication for use.

In case the product is lubricated by the customer, apply class 1 turbin oil (non additive) ISO VG32.

In case the product is lubricated by the customer, be sure to continue lubrication.

If it is discontinued, malfunction may result due to loss of initial lubricant.

Maintenance

⚠ Warning

1. Keep away hands and other body parts from the fingers of the escapement or movement range of the attachment.

It can lead to an injury or accident.

2. When removing the escapement, first block off or remove the workpiece on the primary side of the escapement, release compressed air and remove it.

If the work piece remains, it can be transferred by mistake and cause failure to the equipment on the secondary side.

Finger replacement

1. Remove the hexagon socket head screws.

2. Remove the cover.

3. Replace the finger.

a Apply the specified grease to the finger, body, cover and T groove part of the finger.

b Insert the piston in the T groove so that it will be hooked there.

4. Fix the cover and tighten the hexagon socket head cap screws.

Bore size	Hexagon socket head cap screw	Hexagon width across flats	Tightening torque (N·m)
8	M2 x 6	1.5	0.24
12	M2.5 x 6	2	0.36
20	M4 x 10	3	1.5
25	M5 x 14	4	3.0
32	M6 x 15	5	5.2

Note) For assembly, apply Henkel Japan Loctite No.243 or equivalent adhesive and tighten with the specified tightening torque.

Maintenance

⚠ Warning

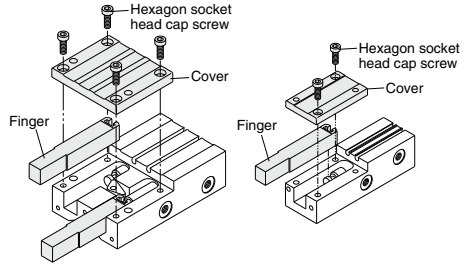

Finger and piston connection

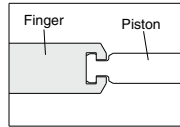

Replacement Procedure of Seal

1. Remove the cover and the finger. (Refer to Replacement Procedure of Finger)

2. Loosen the hexagon socket set screws. (Refer to the table of hexagon socket set screw size).

* For MIS, hexagon socket set screw is not included except for the stroke adjusting type.

3. Remove the retaining ring with spring pliers to remove the cap.

* If there are any questions for ø8, please consult SMC.

Bore size	Hexagon socket set screw	Hexagon width across flats	Tightening torque (N·m)
8	M2 x 6	0.9	0.176
12	M2 x 6	0.9	0.176
20	M3 x 8	1.5	0.63
25	M4 x 8	2	1.5
32	M4 x 8	2	1.5

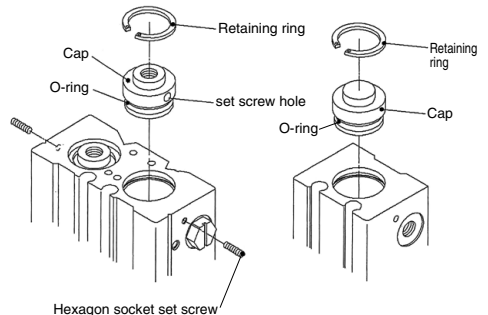



MIW/MIS Series

Specific Product Precautions 4

Be sure to read this before handling the products.

Refer to page 9 for safety instructions and pages 10 to 19 for actuator and auto switch precautions.

Maintenance

Warning

4. Take out the piston assembly and replace the seal, to which the specified grease is applied.

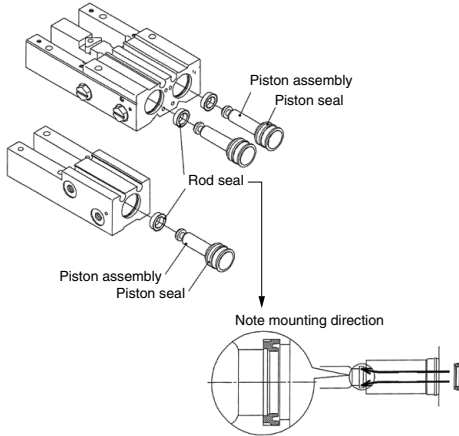

5. Apply the specified grease lightly to the sliding interface between the outer periphery and the body of the piston, and assemble them in the reversed order.

Scraper Option

Caution

1. Please observe the specified torque limits when mounting a scraper.

A tightening torque above the specified limits can cause a damage, while tightening torque below the specified limits can cause a dislocation or drop off.

Tightening torque

Model	Bolt (N-m)
MIW8	0.176
MIS8	
MIW12	0.36
MIS12	
MIW20	0.63
MIS20	
MIW25	0.63
MIS25	
MIW32	1.5
MIS32	

