

Refrigerated Air Dryer

IDFA□E/F Series

For use in Europe, Asia and Oceania



Standard/IDFA□E Series

●Power supply voltage: Single-phase 230 VAC (50Hz)

Model	Rated inlet condition	Air flow capacity (m ³ /h [ANR])			Port size	Page
		Outlet air pressure dew point				
		3°C	7°C	10°C		
IDFA3E	35°C 0.7 MPa	12.0	15.0	17.0	Rc 3/8	130 to 132
IDFA4E		24.0	31.0	34.0	Rc 1/2	
IDFA6E		36.0	46.0	50.0	Rc 3/4	
IDFA8E		65.0	83.0	91.0		
IDFA11E		80.0	101.0	112.0	Rc 1	148 to 155
IDFA15E1		120.0	152.0	168.0		
IDFA22E		182.0	231.0	254.0	R 1	
IDFA37E		273.0	347.0	382.0	R 1 1/2	
IDFA55E		390.0	432.0	510.0	R 2	
IDFA75E		660.0	720.0	822.0		



Refrigerant **R134a(HFC)**
R407C(HFC)

Coefficient of destruction
for ozone is zero.

Improved corrosion resistance with
the use of stainless steel, plate type
heat exchanger (IDFA4E to 75E, 100F to 150F)

Large size/IDFA□F Series

●Power supply voltage: Three-phase 380 VAC (50Hz) For Asia and Oceania
Three-phase 400 VAC (50Hz) For Europe

Tolerant of high temperature environment!
Top of its class in the industry for the large
air-cooled type
Ambient temperature **45°C** at max.
Inlet air temperature **60°C** at max.

Energy saving design
Exhaust heat reduced by 25% at max.
Ambient temperature increase suppressed.
Employs a heat exchanger made of high
corrosion-resistant stainless steel.

Refrigerant **R407C(HFC)**

Coefficient of destruction
fro ozone is zero.



Model	Rated inlet condition	Outlet air pressure dew point	Air flow capacity (m ³ /h [ANR])	Port size	Page
IDFA100F-38	40°C 0.7 MPa	10°C	960	R 2	134 to 136
IDFA125F-38			1210	R 2 1/2	
IDFA150F-38			1500	DIN flange 80	
IDFA100F-40	35°C 0.7 MPa	3°C	860	R 2	
IDFA125F-40			1100	R 2 1/2	
IDFA150F-40			1340	DIN flange 80	

1. Standard Products IDFA□E Series



Model	Rated inlet condition	Air flow capacity (m³/h [ANR])			Refrigerant	Port size	Page
		Outlet air pressure dew point					
		3°C	7°C	10°C			
IDFA3E	35°C 0.7 MPa	12	15	17	R134a (HFC)	Rc3/8	130 to 132
IDFA4E		24	31	34		Rc1/2	
IDFA6E		36	46	50		Rc3/4	
IDFA8E		65	83	91			
IDFA11E		80	101	112			
IDFA15E1		120	152	168	R410A (HFC)	Rc1	148 to 155
IDFA60		204	300	360		R1	
IDFA70		312	408	480		R1 1/2	
IDFA80		552	654	720		R2	
IDFA90		810	900	960			

2. Large size IDFA□F Series



Model	Rated inlet condition	Outlet air pressure dew point	Air flow capacity (m³/h [ANR])	Port size	Page
IDFA100F-38	40°C 0.7 MPa	10°C	960	R2	134 to 136
IDFA125F-38			1210	R2 1/2	
IDFA150F-38			1500	DIN flange 80	
IDFA100F-40	35°C 0.7 MPa	3°C	860	R2	
IDFA125F-40			1100	R2 1/2	
IDFA150F-40			1340	DIN flange 80	

3. Options

Specifications	Applicable model	Suffix (Option symbol)	Page
Cool compressed air output	IDFA3E to 11E	IDFA□E-23-A	137
Anti-corrosive treatment	IDFA3E to 15E1 IDFA100F to 150F	IDFA□E-23-C IDFA□F-□-C	
With Chinese labels and a Chinese operation manual	IDFA3E to 15E1 IDFA100F to 150F	IDFA□E-23-G IDFA□F-□-G	
For medium air pressure (Up to 1.6 MPa)	IDFA6E to 15E1 IDFA100F to 150F	IDFA□E-23-K IDFA□F-□-K	
With heavy duty auto drain (For medium air pressure)	IDFA4E to 15E1	IDFA□E-23-L	
With circuit breaker	IDFA4E to 15E1 IDFA100F to 150F	IDFA□E-23-R IDFA□F-□-R	138
With terminal block for power supply, run & alarm signal and remote operation	IDFA4E to 15E1	IDFA□E-23-T	
Timer type solenoid valve with auto drain (Applicable to medium air pressure)	IDFA4E to 15E1 IDFA100F to 150F	IDFA□E-23-V IDFA□F-□-V	

4. Optional Accessories

Description	Page
Dust-protecting filter set	139
Foundation bolt set	

IDFA□E Series Model Selection

The corrected air flow capacity, which considers the user's operating conditions, is required for selecting the air dryer. Please select using the following procedures.

However, for 400 VAC, model should also be selected based on the amount of processed air of 380 VAC regarding IDFA100F to 150F. (Correction factor is based on the rated conditions of 380 VAC, so when the factor of rated conditions of 400 VAC is inputted, the amount of processed air of 400 VAC can be found.)

1 Read the correction factor.

Obtain the correction factor A to D suitable for your operating condition using the table below.

2 Calculate the corrected air flow capacity.

Obtain the corrected air flow capacity from the following formula.
Corrected air flow capacity = Air consumption ÷ (Correction factor A x B x C)

3 Select the model.

Select the model which air flow capacity exceeds the corrected air flow capacity using the specification table. (For air flow capacity, refer to the data D below.)

4 Option

5 Finalize the model number.

6 Select accessories sold separately.

IDFA□E Selection Example

Condition	Data symbol	Correction factor ^(Note)
Inlet air temperature	40°C	A
Ambient temperature	35°C	B
Inlet air pressure	0.5 MPa	C
Air consumption	31 m ³ /h	—

Note) Values obtained from the table below.

Corrected air flow capacity = 31 m³/h ÷ (0.83 x 0.83 x 0.92) = 48.9 m³/h

According to the corrected air flow capacity of 48.9 m³/h, the **IDFA8E** will be selected when the required output air pressure dew point is 3°C. The **IDFA6E** will be selected when the required pressure dew point is 10°C.

Refer to pages 137 and 138.

Refer to pages 130, 133 and 134.

Refer to page 139.

Data A: Inlet Air Temperature

Inlet air temperature (°C)	Correction factor		Inlet air temperature (°C)	Correction factor	
	IDFA3E to 11E	IDFA15E1		IDFA100F to 150F	IDFA15E1
5 to 25	1.30		5 to 30	1.41	
30	1.25		35	1.21	
35	1		40	1	
40	0.83		45	0.92	
45	0.7		50	0.75	
50	0.6		55	0.63	
			60	0.53	

Data B: Ambient Temperature

Ambient temperature (°C)	Correction factor		Ambient temperature (°C)	Correction factor	
	IDFA3E to 11E	IDFA15E1		IDFA100F to 150F	IDFA15E1
20	1.1	1.1	2 to 25	1.06	
25	1	1	30	1.02	
30	0.91	0.97	32	1	
35	0.83	0.89	35	0.99	
40	0.79	0.77	40	0.98	
			45	0.92	

Data C: Inlet Air Pressure

Inlet air pressure (MPa)	Correction factor		Inlet air pressure (MPa)	Correction factor	
	IDFA3E to 11E	IDFA15E1		IDFA100F to 150F	IDFA15E1
0.3	0.80	0.72	0.2	0.84	
0.4	0.87	0.81	0.3	0.87	
0.5	0.92	0.88	0.4	0.9	
0.6	0.96	0.95	0.5	0.93	
0.7	1.00	1.00	0.6	0.96	
0.8	1.04	1.06	0.7	1	
0.9	1.07	1.11	0.8	1.03	
1	1.1	1.16	0.9	1.06	
1.2	1.16	1.21	1 to 1.6	1.09	
1.4	1.21	1.25			
1.6	1.25	1.27			

Data D: Air Flow Capacity

Model		Air flow capacity (m ³ /h [ANR])				
		IDFA3E	IDFA4E	IDFA6E	IDFA8E	IDFA11E
Outlet air pressure dew point	3°C	12	24	36	65	80
	7°C	15	31	46	83	101
	10°C	17	34	50	91	112

Model		Air flow capacity (m ³ /h [ANR])
		IDFA15E1
Outlet air pressure dew point	3°C	120
	7°C	152
	10°C	168

Model		Air flow capacity (m ³ /h [ANR])		
		IDFA100F	IDFA125F	IDFA150F
Outlet air pressure dew point	3°C	670	860	1045
	7°C	816	1029	1275
	10°C	960	1210	1500

Note1) In the case of the option A (cool compressed air output), the air flow capacity is different. Refer to page 137 for details. (IDFA3E to 11E)

Note2) The outlet air pressure dew point varies depending on the operating conditions.

Particularly when the outlet air pressure dew point is 3°C or 7°C, though this depends on the operating conditions, freeze protection functions may be activated, resulting in the dew point rising and becoming unstable.
If a stable low dew point is required, consider an IDG series membrane air dryer.

Refrigerant R134a (HFC)

IDFA□E Series

3E, 4E, 6E, 8E, 11E, 15E

(Max. inlet air temperature: 50°C, Max. ambient temperature: 40°C)



How to Order

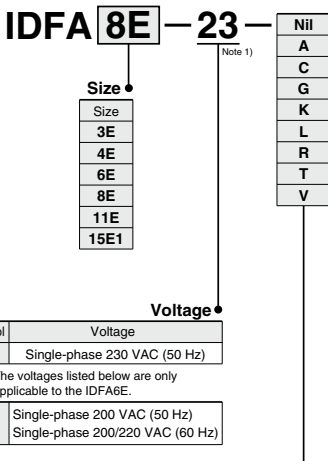

Options and Available Combinations (Size/Option)

Symbol ^{Note 2)}	Nil	A	C	G	K	L	R	T	V
Option	None	Cool compressed air output	Anti-corrosive treatment	With Chinese labels and a Chinese operation manual	Moderate pressure specification ^{Note 3)} (Auto drain bowl type: Metal bowl with level gauge)	With heavy duty auto drain (Applicable to moderate pressure) ^{Note 3)}	With circuit breaker	With terminal block for run & alarm signal	Timer type solenoid valve with auto drain (Applicable to moderate pressure) ^{Note 3)}
Size									
3E	●	●	●	●	—	—	—	—	—
4E	●	●	●	●	—	●	●	●	●
6E	●	●	●	●	●	●	●	●	●
8E	●	●	●	●	●	●	●	●	●
11E	●	●	●	●	●	●	●	●	●
15E1	●	—	●	●	●	●	●	●	●

Note 1) G thread (PF thread) can accept the R thread (PT male thread), thus making no "F" in the thread specification setting. A conversion hexagon nipple for the R thread (PT male thread) is also contained.

Note 2) Enter alphabetically when multiple options are combined.

However, the following combination cannot be achieved.

• Combination of K, L and V cannot be achieved because an auto drain can only be attached to a single option.

Note 3) The maximum operating pressure is 1.6 MPa.

Note 4) Refer to pages 137 and 138 for further details on optional specifications.

Note 5) Option "H" (Auto-drain bowl type: Metal bowl) is only applicable to the IDFA6E-20. However, options K, L, and V cannot be selected in combination.

Standard Specifications



Specifications		Model		Standard temperature air inlet					
				IDFA3E	IDFA4E	IDFA6E ^{Note 9)}	IDFA8E	IDFA11E	IDFA15E1
Operating range	Fluid	Compressed air							
	Inlet air temperature (°C)	5 to 50							
	Inlet air pressure (MPa)	0.15 to 1.0 ^{Note 10)}							
	Ambient temperature (Humidity) (°C)	2 to 40 (Relative humidity of 85% or less)							
Rated specifications ^{Note 4)}	Air flow capacity ^{Note 1)} m ³ /h Standard condition (ANR)	Outlet air pressure dew point (3°C)	12	24	36	65	80	120	
		Outlet air pressure dew point (7°C)	15	31	46	83	101	152	
	Outlet air pressure dew point (10°C)	17	34	50	91	112	168		
	Air flow capacity ^{Note 2)} m ³ /h Compressor intake condition	Outlet air pressure dew point (3°C)	13	25	37	68	83	125	
		Outlet air pressure dew point (7°C)	16	32	48	86	105	158	
		Outlet air pressure dew point (10°C)	18	35	52	95	116	175	
Inlet air pressure (MPa)		0.7							
Inlet air temperature (°C)		35							
Ambient temperature (°C)		25							
Power supply voltage		Single-phase: 230 VAC [Voltage fluctuation ±10%] 50 Hz							
Electrical parameters	Power consumption ^{Note 6)} (W)	180		208		385		420	
	Operating current ^{Note 6)} (A)	1.2		1.4		2.7		2.9	
Applicable circuit breaker capacity ^{Note 5)} (sensitivity current 30 mA) (A)		5						10	
Condenser		Air-cooled							
Refrigerant		R134a (HFC)							
Refrigerant charge (kg)		0.15	0.2	0.23	0.27	0.29	0.35		
Auto drain		Float type (Normally open)							
Port size		Rc 3/8	Rc 1/2	Rc 3/4			Rc 1		
Accessory		Hexagon nipple							
Weight (kg)		18	22	23	27	28	46		
Compliant standards		EC Directive (with CE/UKCA marking)							

Symbol

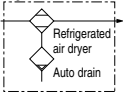

- Note 1) Air flow capacity under the standard condition (ANR) [atmospheric pressure at 20°C, relative humidity at 65%]
 Note 2) Air flow capacity converted by the compressor intake condition [atmospheric pressure at 32°C, relative humidity at 75%].
 Note 3) The operation range does not guarantee the use with normal air flow capacity.
 Note 4) Please select a model in accordance with the Model Selection (Page 129).
 Note 5) Product other than the option R is not equipped with an earth leakage breaker. Please purchase an appropriate earth leakage breaker separately.
 Note 6) These values are reference values under rated conditions, and are not guaranteed. Do not use these values for the thermal set values, etc.
 Note 7) When a short-term interruption of the power supply (including momentary interruption) occurs in this equipment, the restarting of normal operations may require some time or may be impossible due to the operation of protective devices even after the supply of power returns.

Replacement Parts

Model		IDFA3E	IDFA4E	IDFA6E	IDFA8E	IDFA11E	IDFA15E1
Auto drain replacement part no. ^{Note 9)}	New	AD38-A		AD48-A			
	Previous	AD38		AD48			

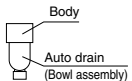

- Note 8) The part number for the auto drain (Bowl assembly) components without including the body part. Body part replacement is impossible. In addition, a new line of auto drain models was recently introduced in March 2019. The previous models and the new models do not have mounting interchangeability. For details, refer to page 140.
 Note 9) The specifications of the IDFA6E-20 are the same as those of the IDFA6E-20 (page 43) aside from the compliant standards.
 Note 10) The maximum operating pressure is 1.0 MPa as standard, but it is possible to achieve 1.6 MPa when selecting Option K, Option L, or Option V.

Construction Principle (Air/Refrigerant Circuit)

Humid, hot air coming into the air dryer will be cooled down by a cooler re-heater (heat exchanger). Water condensed at this time will be removed from the air by auto drain and drained out automatically. Air separated from the water will be heated by a cooler re-heater (heat exchanger) to obtain the dried air, which then goes through to the outlet side.

IDFA3E

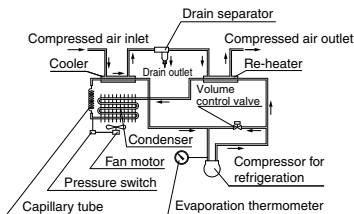

IDFA4E, IDFA6E IDFA8E, IDFA11E, IDFA15E1

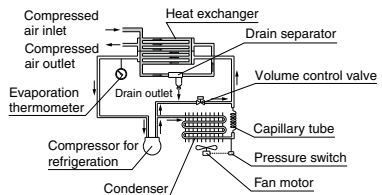

IDFA□E Series

Dimensions

IDFA3E to 15E1

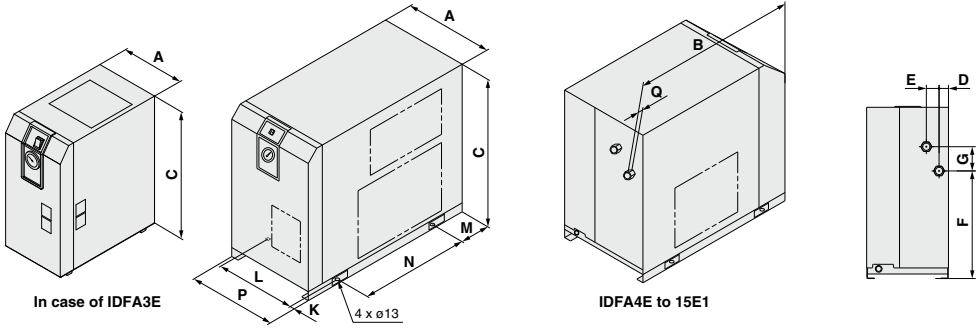

Dimensions

Model	Port size	A	B	C	D	E	F	G	K*	L*	M*	N*	P	Q
IDFA3E	Rc 3/8	226	410	473	67	125	304	33	36	154	21	330		15
IDFA4E	Rc 1/2		453	498			283					275		13
IDFA6E		270	455		31	42		80	15	240	80		300	
IDFA8E	Rc 3/4		485	568			355							15
IDFA11E														
IDFA15E1	Rc 1	300	603	578	41	54	396	87		43	101	380	314	16

* Meaning the foot dimensions for the IDFA3E.

Refrigerant R407C (HFC)

IDFA□E Series

22E,37E,55E,75E

(Inlet air temperature: 35°C)



The production of the IDFA22E to 75E series has been discontinued.

Discontinued products

IDFA22E

IDFA37E

IDFA55E

IDFA75E

New type
p. 143

IDFA60

IDFA70

IDFA80

IDFA90

For Use in Europe,
Asia and Oceania

Applicable for the high-temperature environments

Ambient temperature: Max. 45°C

Inlet air temperature : Max. 65°C

Air flow capacity * IDFA90-23, Dew point of 3°C

810 m³/h (23% increase compared to the existing model)

Power supply voltage

Single-phase 230 VAC (50 Hz)

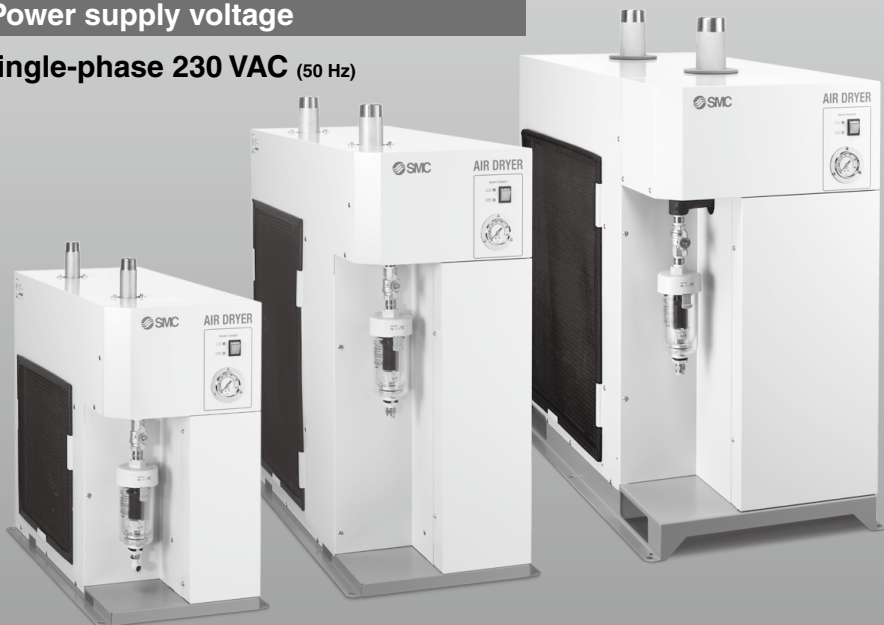

Refrigerant R407C (HFC)

IDFA100F/125F/150F Series

For use in Europe, Asia and Oceania

(Max. inlet air temperature: 60°C, Max. ambient temperature: 45°C)



How to Order

For use in
Asia and Oceania

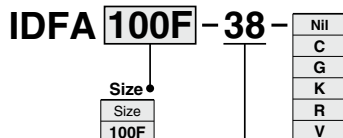

Size

Size
100F
125F
150F

Voltage

Symbol	Voltage
38	Three-phase 380 VAC (50 Hz)

Option

Symbol ^(Note)	Description
Nil	None
C	Anti-corrosive treatment for copper tube
G	With Chinese labels and a Chinese operation manual
K	Moderate pressure specification (1.6 MPa)
R	With a circuit breaker
V	With a timer controlled solenoid valve type auto drain

Note) Enter alphabetically when multiple options are combined.
Example: When the IDFA100F-38 is provided with options C or R or V, the model number will be the IDFA100F-38-CRV.

For use in Europe

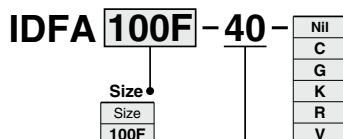

Size

Size
100F
125F
150F

Voltage

Symbol	Voltage
40	Three-phase 400 VAC (50 Hz)

Option

Symbol ^(Note)	Description
Nil	None
C	Anti-corrosive treatment for copper tube
G	With Chinese labels and a Chinese operation manual
K	Moderate pressure specification (1.6 MPa)
R	With a circuit breaker
V	With a timer controlled solenoid valve type auto drain

Note) Enter alphabetically when multiple options are combined.
Example: When the IDFA100F-40 is provided with options C or R or V, the model number will be the IDFA100F-40-CRV.

Refrigerated Air Dryer *IDFA100F/125F/150F Series*

Standard Specifications



Specifications	Model	For use in Asia and Oceania			For use in Europe		
		IDFA100F-38	IDFA125F-38	IDFA150F-38	IDFA100F-40	IDFA125F-40	IDFA150F-40
Operating conditions	Fluid	Compressed air					
	Inlet air temperature °C	5 to 60					
	Inlet air pressure MPa	0.15 to 1.0 (Note 6)					
	Ambient temperature (humidity) °C	2 to 45 (Relative humidity 85% or less)					
Rated conditions	Air flow capacity m ³ /h	960	1210	1500	860	1100	1340
	Inlet air pressure MPa	0.7					
Rated conditions	Inlet air temperature °C	40			35		
	Ambient temperature °C	32			25		
	Outlet air pressure dew point °C	10			3		
	Power supply voltage	Three-phase 380 VAC			Three-phase 400 VAC		
Electrical specifications	Power consumption kW	2.8	3.4	3.4	2.5	2.7	2.7
	Operating current A	5.1	6.3	6.3	4.5	5.3	5.9
Applicable circuit breaker capacity (Note 4) A	15						
Heat discharge from condenser kW	7.5		9	11.5	7	8	10
Refrigerant	R407C (HFC)						
Refrigerant charge kg	1.25	1.36	2.0	1.25	1.36	1.8	
Auto drain	Float type (Normally open) The option V stands for a timer type solenoid valve.						
Port size	R2	R2 1/2	DIN flange 80	R2	R2 1/2	DIN flange 80	
Weight kg	245	270	350	245	270	350	
Compliant standards	EC Directive compliant (with CE/UKCA marking)						

Note 1) Air flow capacity under the standard condition (ANR) [atmospheric pressure 20°C, relative humidity 65%]

Note 2) Air flow capacity converted by the compressor intake condition [atmospheric pressure 32°C]

Note 3) The operation range does not guarantee the use with normal air flow capacity. When operating conditions are different from the rated specifications, please select a model in accordance with Model Selection (page 129).

Note 4) Install a circuit breaker with a sensitivity 30 mA.

Replacement Parts

Air dryer model	IDFA100F	IDFA125F	IDFA150F
Heavy duty auto drain replacement part no. (Note 5)	ADH-E400		
Dustproof filter set for condenser	IDF-FL219	IDF-FL220	

Note 5) Part number of only the exhaust mechanism replacement kit excluding the housing

Note 6) The maximum operating pressure is 1.0 MPa as standard, but it is possible to achieve 1.6 MPa when selecting Option K.

* A terminal block for remote operation, stop, operating, and error signals is included as standard equipment.

Symbol

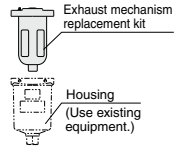
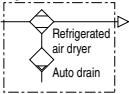

Construction (Air/Refrigerant Circuit)

IDFA100F/125F/150F

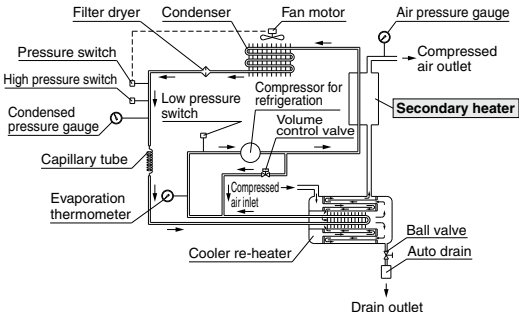

Hot and humid air entering the air dryer is cooled down by the cooler re-heater (heat exchanger). The moisture which is condensed and separated is automatically exhausted by the auto drain. The air which has had its moisture removed is heated in two stages by the re-heater (heat exchanger) in the cooler re-heater and by the secondary heater, and is supplied to the outlet side as warm and dry air.

Secondary heater

Compressed air from which drainage has been exhausted exchanges heat with refrigerant which has been compressed by the refrigerator, to give the following effects:

1. The outlet air temperature increases, preventing condensation of the piping on the outlet side.
2. The amount of heat exhausted from the condenser is reduced.
3. Energy saving operation of the dryer is achieved by reducing the amount of heat exhausted from the condenser.

IDFA 100F/125F/150F Series

Dimensions

IDFA100F/125F

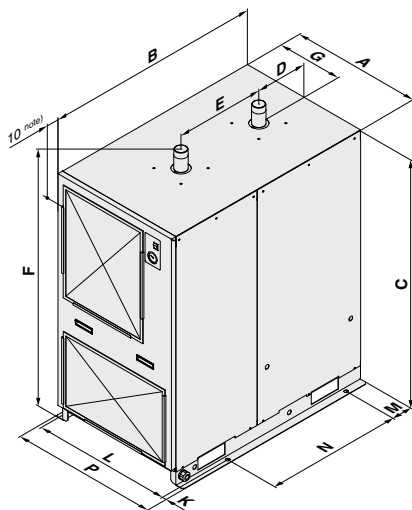

Note) In addition to the overall length of the body, the filter mounting part (bracket) projects 10 mm.

Dimensions

(mm)

Model	Port size	A	B	C	D	E	F	G	K	L	M	N	P
IDFA100F	R2	670	1120	1276	267	460	1375	335	20	712	107	700	752
IDFA125F	R2 1/2	700				655		350			78	935	

IDFA150F

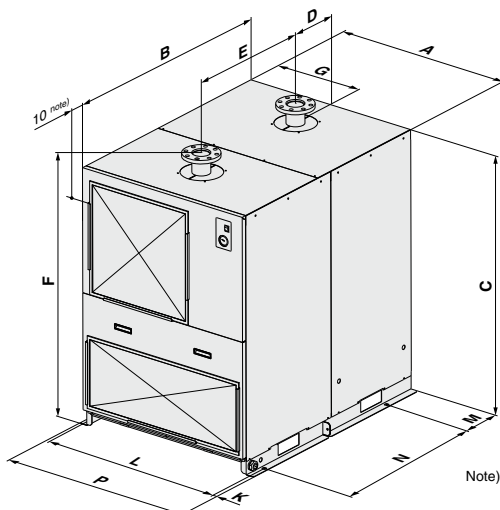

Note) In addition to the overall length of the body, the filter mounting part (bracket) projects 10 mm.

Dimensions

(mm)

Model	Port size	A	B	C	D	E	F	G	K	L	M	N	P
IDFA150F	DIN flange 80	950	1290	1332	268	720	1432	475	20	990	217	935	1030

IDFA□E/F Series Options 1

For "How to Order" optional models, refer to pages 130, 133 and 134.

A Option symbol Cool compressed air output IDFA3E to 11E

There is no heating of cooled, dehumidified air as it leaves the air dryer. The air flow capacity with this option is smaller than that of the standard dryer. (The external dimensions are identical with the standard product.)
 (Note) Perform thermal insulation treatment for piping and equipment installed after the dryer to prevent the formation of condensation.

Air Flow Capacity

Model	IDFA3E	IDFA4E	IDFA6E	IDFA8E	IDFA11E
Air flow capacity m ³ /h (ANR)	8	23	29	32	39

Conditions: Inlet air pressure: 0.7 MPa, Inlet air temperature: 35°C,
 Outlet air temperature: 10°C Ambient temperature: 25°C

C Option symbol Anti-corrosive treatment IDFA all models

This minimizes the corrosion of the copper and copper alloy parts when the air dryer is used in an atmosphere containing hydrogen sulfide or sulfuric acid gas. (Corrosion cannot be completely prevented.)
 Special epoxy coating: Copper tube and copper alloy parts.
 The coating is not applied on the heat exchanger or around electrical parts, where operation may be affected by the coating.

* Corrosion is not covered under warranty.

G Option symbol With Chinese labels and a Chinese operation manual IDFA all models

In addition, Chinese labels are put on the external panels.
 A Chinese operation manual is also included.

K Option symbol Moderate pressure specification (Auto drain bowl type: Metal bowl with level gauge) IDFA6E to 15E1

The auto drain is changed from the standard one to one with a moderate pressure specification.
 A metal bowl with a level gauge which can confirm the water level is used for the auto drain.

Specifications

1. Maximum operating pressure: 1.6 MPa
2. Dimensions ... same as standard products

Replacement Parts

Model	Auto drain assembly part no.	Note
IDFA6E to 15E1	IDF-S1926	The AD48-8-A-X2112 auto drain (bowl assembly) excluding the body, insulator, and One-touch fitting are included.

* A new line of auto drain models was recently introduced in March 2019. The previous models and the new models do not have mounting interchangeability. For details, refer to page 140.

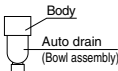

K Option symbol Moderate pressure specification IDFA100F to 150F

The maximum operating pressure is 1.6 MPa.
 The internal drain piping material is changed from nylon to metal.

Specifications

1. Maximum operating pressure: 1.6 MPa
2. Dimensions ... same as standard products

L Option symbol With heavy duty auto drain (Applicable to moderate pressure) IDFA4E to 15E1

The float type auto drain used in the standard air dryer is replaced with a heavy duty auto drain (ADH4000-04) which enables the drainage to discharge more efficiently.

Dimensions (mm)	
Model	A
IDFA4E	55
IDFA6E	67
IDFA8E, 11E	139
IDFA15E1	47

IDFA4E to 15E1

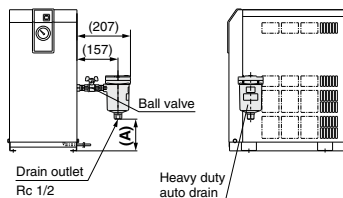

Replacement Parts: Heavy Duty Auto Drain

Model	Replacement part no. (Description)	Configuration
IDFA4E to 15E1	ADH4000-04 (Heavy duty auto drain)	Heavy duty auto drain

IDFA□E/F Series Options 2

For "How to Order" optional models, refer to pages 130, 133 and 134.

R Option symbol With circuit breaker IDFA4E to 15E1, IDFA100F to 150F

A circuit breaker with cover is attached to the side of the air dryer. This saves additional electrical wiring at the time of installation.

IDFA4E to 15E1

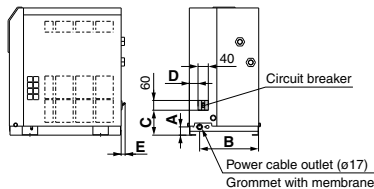

Dimensions (mm)

Model	A	B	C	D	E
IDFA4E, 6E, 8E, 11E	32	230	97	34	15
IDFA15E1	43	258	102	82	—

IDF100F to 150F

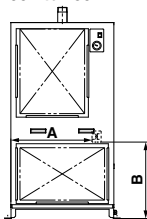

Dimensions (mm)

Model	A	B
IDFA100F	509	535
IDFA125F	505	
IDFA150F	628	

Breaker Capacity and Sensitivity Current

Voltage	Model	Breaker capacity	Sensitivity current
230 V type	IDFA4E-23, IDFA6E-23 IDFA8E-23, IDFA11E-23	5 A	30 mA
	IDFA15E1-23	10 A	
	IDFA100F, IDFA125F IDFA150F	15 A	

T Option symbol With terminal block for power supply, run & alarm signal and remote operation IDFA4E to 15E1

In addition to the terminals for the power supply, terminals for the operating signal and the error signal are also available. (No-voltage contact)
Also, in the case of remote control, operate it from the power supply side while the air dryer switch remains ON.

Contact capacity: 230 VAC, 4 A 24 VDC, 5 A for operating and error signals.

Minimum current value: 20 V, 5 mA (AC/DC) for operating and error signals.

Note 1) Terminal block for power supply, run & alarm signal and remote operation is mounted on the standard types of the IDFA100F to 150F.

Note 2) Please be sure to confirm the electric circuits with the drawings or instruction manual before using the output signal.

IDFA4E to 15E1

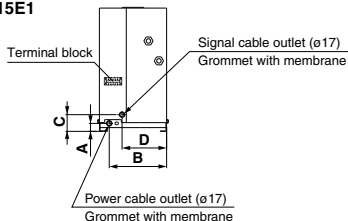

Dimensions (mm)

Model	A	B	C	D
IDFA4E, 6E, 8E, 11E	32	230	67	179
IDFA15E1	43	258	77	158

V Option symbol Timer type solenoid valve with auto drain IDFA4E to 15E1 IDFA100F to 150F (Applicable to moderate pressure)

Drainage is discharged by controlling a solenoid valve with a timer.
A strainer for solenoid valve protection and stop valve are also included. (Dimensions are the same as the standard type.)



Maximum operating pressure: 1.6 MPa (IDFA100F to 150F: 1.0 MPa)

* The timer-type solenoid valve actuates once (for 0.5 s) every 30 s.

Replacement Parts

Model	Part no.	Note
IDFA4E to 15E1	IDF-S0198	230 VAC
IDFA100F to 150F	IDF-S0405	200 VAC

IDFA□E/F Series Optional Accessories

	Features	Specifications	Applicable dryer
Dust-protecting filter set 	Prevents a decline in the performance of the air dryer, even in a dusty atmosphere.	Max. ambient temperature 40°C	IDFA3E to 75E
Foundation bolt set 	Bolts for fixing the air dryer to the foundations. Easy to secure by striking its axle.	Stainless steel	IDFA4E to 75E IDFA100F to 150F

How to Order

Dust-protecting filter set

IDF — FL **209**

Applicable dryer

Symbol	Applicable dryer
209	IDFA3E
202	IDFA4E
203	IDFA6E
204	IDFA8E
205	IDFA11E
206	IDFA15E1

Foundation bolt set

IDF — AB **500**

Applicable dryer

Symbol	Applicable dryer
500	IDFA4E to 15E1
501	IDFA100F to 150F

Dust-protecting Filter Set/Dimensions

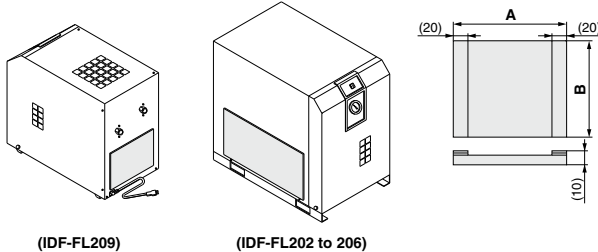

Dimensions

Part no.	Applicable dryer	A	B	Weight (g)
IDF-FL209	IDFA3E	220	240	35
IDF-FL202	IDFA4E	310		45
IDF-FL203	IDFA6E	375	195	55
IDF-FL204	IDFA8E	340		70
IDF-FL205	IDFA11E	375	265	75
IDF-FL206	IDFA15E1	440	370	120

Foundation Bolt Set/Dimensions

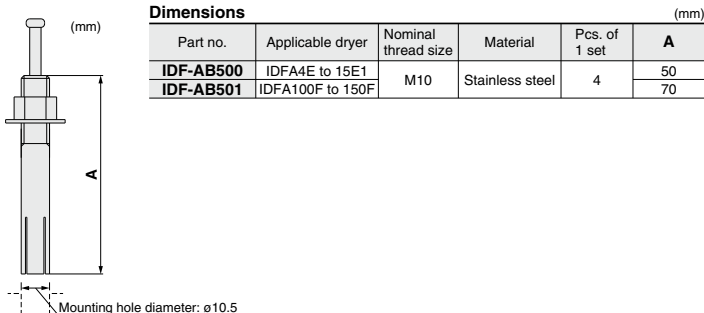

Dimensions

Part no.	Applicable dryer	Nominal thread size	Material	Pcs. of 1 set	A
IDF-AB500	IDFA4E to 15E1	M10	Stainless steel	4	50
IDF-AB501	IDFA100F to 150F				70

IDFA□E Series

Auto Drain Replacement Parts: Previous and New Model Product Nos.

A new line of auto drain models, which feature new product numbers and a new shape, was recently introduced, with manufacturing starting in either March or June 2019 (depending on the model). The previous auto drain models and the new auto drain models do not have mounting interchangeability. Please check the serial number on the dryer specification label before ordering.

Auto drain (Bowl assembly)

Previous model



Metal bowl guard

New model



Transparent bowl guard
(Polycarbonate)

Dryer model	Auto drain (Bowl assembly) part no.	Manufacturing date	SERIAL No.
IDFA3E/4E	Previous AD38	Manufactured in February 2019 and before	XP and before
	New AD38-A	Manufactured in March 2019 and after	XQ and after
IDFA6E/8E/11E/15E1/22E/37E	Previous AD48	Manufactured in February 2019 and before	XP and before
	New AD48-A	Manufactured in March 2019 and after	XQ and after
IDFA55E/75E	Previous AD48	Manufactured in May 2019 and before	XS and before
	New AD48-A	Manufactured in June 2019 and after	XT and after

Option: K Moderate pressure specification (Auto drain bowl type: Metal bowl with level gauge)

Previous model



New model



Dryer model	Auto drain (Bowl assembly) part no.	Manufacturing date	SERIAL No.
IDFA6E/8E/11E/15E1 -K	Previous IDF-S0086 *1	Manufactured in February 2019 and before	XP and before
	New IDF-S1926 *2	Manufactured in March 2019 and after	XQ and after
IDFA22E/37E -K	Previous AD48-8-X2110	Manufactured in February 2019 and before	XP and before
	New AD48-8-A-X2112	Manufactured in March 2019 and after	XQ and after

*1 Assembly of auto drain: AD48-8-X2110, One-touch fitting: KQ2H10-02AS, and insulator
*2 Assembly of auto drain: AD48-8-A-X2112, One-touch fitting: KQ2H10-02AS, and insulator

Dryer specification label Serial number confirmation method

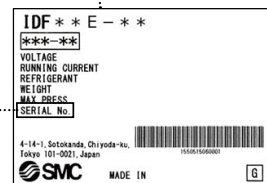
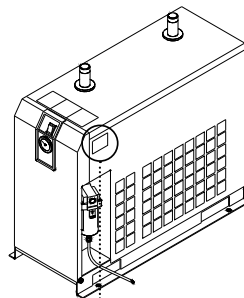

Specification Label

SERIAL No.: **X Q**

Manufacturing year

Symbol	Year
A	1996
B	1997
⋮	⋮
W	2018
X	2019
Y	2020
⋮	⋮

Manufacturing month

Symbol	Month
o	1
P	2
Q	3
R	4
S	5
T	6
U	7
V	8
W	9
X	10
y	11
Z	12



IDFA□E/F Series

Specific Product Precautions 1

Be sure to read this before handling the products. For safety instructions and air preparation equipment precautions, refer to the "Handling Precautions for SMC Products" and the "Operation Manual" on the SMC website: <https://www.smcworld.com>

Installation

⚠ Caution

- Avoid locations where the air dryer will be in direct contact with wind and rain. (Places where relative humidity is greater than 85%)
- Avoid exposure to direct sunlight.
- Avoid locations that contain much dust, corrosive gases, or flammable gases. Failure due to corrosion is not covered under warranty. However, when the risk of corrosion is high, select "Option C" (copper tubing with anti-corrosive treatment).
- Avoid locations of poor ventilation and high temperature.
- Avoid too close to a wall etc. Leave sufficient room between the dryer and the wall according to the "Maintenance space" in the operation manual.
- Avoid locations where a dryer could draw in high temperature air that is discharged from an air compressor or other dryer.

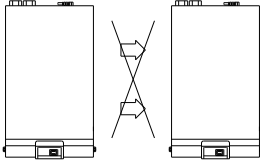

The air exhaust should not flow into the neighboring equipment. (Top side)

- Avoid locations subjected to vibration.
- Avoid possible locations where the drain can freeze.
- Use the air dryer with an ambient temperature lower than 40°C.
- Avoid installation on machines for transporting, such as trucks, ships, etc.
- Avoid locations which experience sudden pressure/flow rate changes.
- When installing in locations where the dripping of condensation is a problem
Depending on the operating conditions, the product and its downstream pipes could drip water due to condensation formed by supercooling.
If this is a problem, install a drain receiver below this product or the condensation points and empty it regularly.
Alternatively, wind additional insulation around the condensation points.

Drain Tube

⚠ Caution

- A polyurethane tube is attached as a drain tube for the IDFA3E to 15E1 and IDFA100F to 150F. Use this tube to discharge drainage.
- Do not use the drain tube in an upward direction. Do not bend or crush the drain tube. (Operation of the auto drain will stop water vapor from discharging through the air outlet.)
If it is unavoidable that the tube goes upwards, make sure it only goes as far as the position of the auto drain.
- The drain tube comes with a tube fitting. Pipe a 10 mm O.D. tube with a length of 5 m or less.

Power Supply

⚠ Caution

- Connect the power supply to the terminal block.
- Install a suitable circuit breaker applicable for the specific model.
- The voltage fluctuation should be maintained within $\pm 10\%$ of the rated voltage.

Note) Select a circuit breaker with a sensitivity current 30 mA. As regards rated current, refer to "Applicable circuit breaker capacity" on pages 131 and 135.

Air Piping

⚠ Caution

- Be careful to avoid an error in connecting the air piping at the compressed air inlet (IN) and outlet (OUT).
- Install by-pass piping since it is needed for maintenance.

IDFA3E

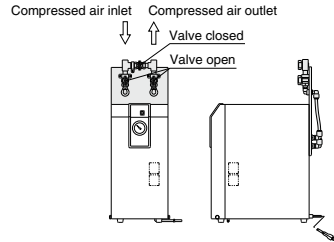

IDFA4E to 15E1

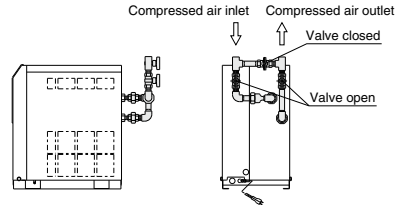



IDFA□E/F Series

Specific Product Precautions 2

Be sure to read this before handling the products. For safety instructions and air preparation equipment precautions, refer to the "Handling Precautions for SMC Products" and the "Operation Manual" on the SMC website: <https://www.smcworld.com>

Air Piping

⚠ Caution

IDFA55E, 75E

Compressed air outlet Compressed air inlet

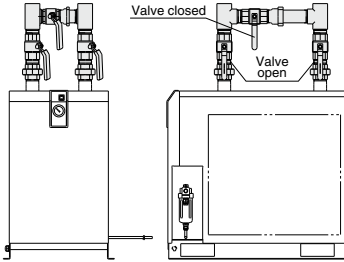

- When tightening piping at the air inlet/outlet tube, the hexagonal parts of the port on the air dryer side or piping should be held firmly with a spanner or adjustable angle wrench.
- Variations in operating conditions may cause condensation to form at the surface of the outlet piping. Apply thermal insulation around the piping to prevent condensation from forming.
- Vibration resulting from the compressor should not be transmitted through air piping to the air dryer.
- Do not allow the weight of the piping to lie directly on the air dryer.
- If a metallic flexible tubing is used for the inlet/outlet air piping, abnormal noise might be generated in the piping. In that case, please change it to the rigid tubing.

Protection Circuit

⚠ Caution

When the air dryer is operated under the following stated conditions, a protection circuit is activated, the light turns off and operation stops.

- When the compressed air temperature is too high.
- When the compressed air flow rate is too high.
- When the ambient temperature is too high. (40°C or higher, however, 45°C or higher for IDFA100F to 150F)
- When the fluctuation of the power supply is beyond the rated voltage $\pm 10\%$.
- When the dryer is drawing in high temperature air that is discharged from an air compressor or other dryer.
- The ventilation port is obstructed by a wall or clogged with dust.

Compressor Air Delivery

⚠ Caution

Use an air compressor with an air delivery of 100 L/min or larger with the IDFA3E to 15E1 series.

Since the auto drain of the IDFA3E to 15E1 is designed in such a way that the valve remains open unless the air pressure rises to 0.15 MPa or higher (0.05 MPa or more for IDFA100F to 150F), air will blow out from the drain discharge port at the time of air compressor start-up until the pressure increases. Therefore, if an air compressor has a small air delivery, the pressure may not be sufficient.

Auto Drain

⚠ Caution

The auto drain may not function properly, depending on the quality of the compressed air. Check the operation once a day.

Cleaning of Ventilation Area

⚠ Caution

Remove dust from the ventilation area once a month using a vacuum cleaner or an air blow nozzle.

Delay for Restarting

⚠ Caution

- Allow at least three minutes before restarting the dryer. If the air dryer is restarted within three minutes after being stopped, the protection circuit will be activated, operating light turns off and the dryer will not be activated.
- The residual drainage in the air dryer may splash over the outlet when the operation is re-started, so it is recommended to install a filter on the outlet of the air dryer.

Modifying the Standard Specifications

⚠ Caution

Do not modify the standard product using any of the optional specifications once the product has been supplied to a customer. Check the specifications carefully before selecting an air dryer. In addition, do not disassemble or modify the product. Products which have been disassembled and/or modified cannot be guaranteed.

■ Refrigerant with GWP reference

Refrigerant	Global Warming Potential (GWP)		
	Regulation (EU) No 517/2014 (Based on the IPCC AR4)	Fluorocarbon Emissions Control Act (Japan) GWP value labeled on products	GWP value to be used for reporting the calculated amount of leakage
R134a	1,430	1,430	1,300
R404A	3,922	3,920	3,940
R407C	1,774	1,770	1,620
R410A	2,088	2,090	1,920

Note 1) This product is hermetically sealed and contains fluorinated greenhouse gases (HFC). When this product is sold on the market in the EU after January 1, 2017, it needs to be compliant with the quota system of the F-Gas Regulation in the EU.

Note 2) See specification table for refrigerant used in the product.