

Refrigerated Air Dryer

IDFB Series

For Use in North, Central and South America



Applicable for the high-temperature environments

Ambient temperature: Max. 113°F (45°C)

Inlet air temperature : Max. 149°F (65°C)

Air flow capacity

* IDFB90-23, Dew point of 50°F (10°C)

459 SCFM (780 m³/h)

(13% increase compared to the current model)

Power supply voltage

Single-phase 230 VAC (60 Hz)

Single-phase 115 VAC (60 Hz)

* IDFB60 only



Applicable for the high-temperature environments

	IDFB Series	Current model IDFB Series
Ambient temperature	Max. 113°F (45°C)	Max. 104°F (40°C)
Inlet air temperature	Max. 149°F (65°C)	Max. 122°F (50°C)

Increased air flow capacity

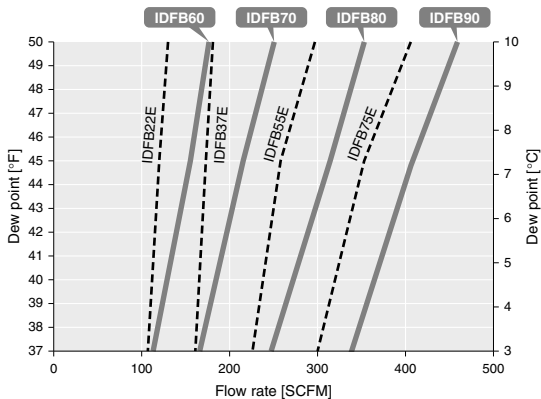

New stainless steel heat exchanger helps reduce the load of the compressor

Easier maintenance

- The temperature range for normal operating conditions is indicated by the green zone.

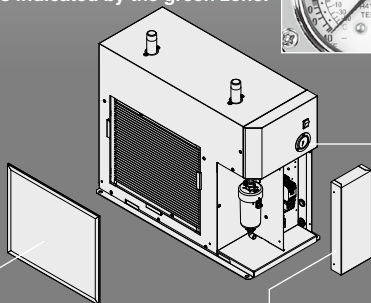
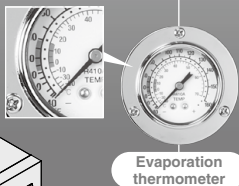

- Dustproof filter provided as a standard accessory

Prevents clogging of the condenser
Can be installed without tools

- All electrical components are located in the front of the product.

The electrical components can be checked by removing the front panel.



Series Variations

Model	Rated inlet condition	Rated ambient temperature	Air flow capacity [SCFM (m³/h)]			Port size*1
			Dew point 37°F (2.8°C)	Dew point 45°F (7.2°C)	Dew point 50°F (10°C)	
IDFB60	100°F (37.8°C) 100 psi (0.7 MPa)	100°F (37.8°C)	113 (192)	155 (264)	177 (300)	R1/ NPT1
IDFB70			166 (282)	215 (366)	251 (426)	R1 1/2/ NPT1 1/2
IDFB80			247 (420)	314 (534)	353 (600)	R2/ NPT2
IDFB90			335 (570)	406 (690)	459 (780)	

*1 Select port sizes when ordering the products.

Options

p. 181

Optional accessories

p. 180



Auto Drain Valve Longer life, Higher resistance to foreign matter

Non-sliding part reduces the catching of foreign matter

Diaphragm type
Poppet type

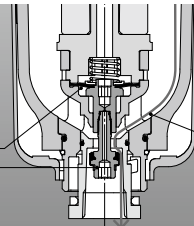

Shape prevents condensate accumulation

Condensate and foreign matter are discharged completely.

Easier maintenance

- One-touch mounting and removal of the bowl is possible without using any tools.

Release the lock by sliding the lock button down while holding the body. Then, rotate the bowl guard and pull down for removal.



Transparent bowl guard

- Allows you to visually check the condensate condition in the bowl
- Improved environmental durability due to 2-layer construction



Drain tube holder (Accessory)

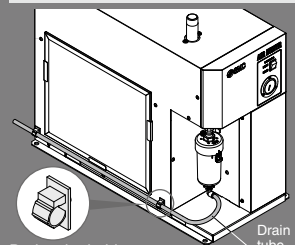

Drain tube holder

Drain tube

Protect Pneumatic Equipment from Moisture!

An air dryer removes the vapor from the moist compressed air delivered by the compressor and prevents it from causing the pneumatic equipment to fail.

Effects of moisture on equipment

- Malfunctioning of valves and actuators caused by dripping grease
- Generation of water droplets
- Decomposition of auto drain caused by rusting inside pipes

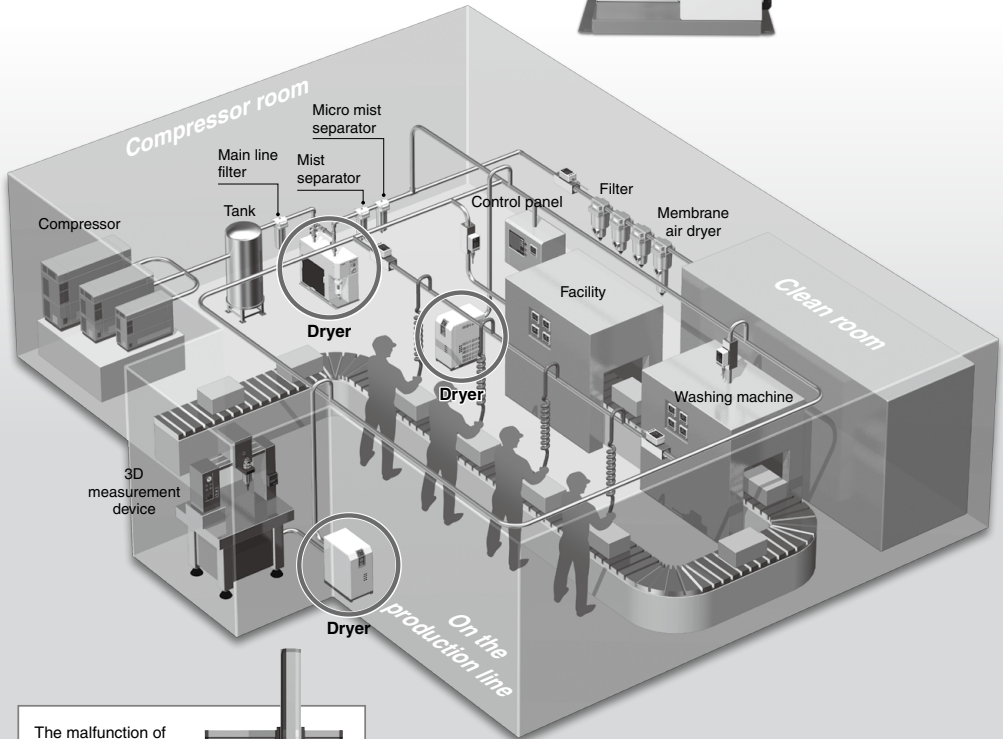

The malfunction of air bearings of 3D measurement device, etc.

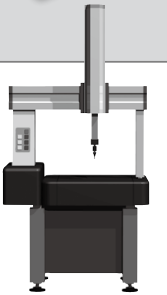

IDFB Series Model Selection

Air dryers should be selected based on the corrected air flow capacity while taking operating environment and facility into account. Select the air dryer model in accordance with the following procedure.

1 Read the correction factors.

Read the correction factors (A) to (C) suitable to the operating conditions.

2 Calculate the corrected air flow capacity.

Obtain the corrected air flow capacity from the following formula.

$$\text{Corrected air flow capacity} = \text{Air flow rate} \div (\text{Correction factor (A)} \times \text{(B)} \times \text{(C)})$$

3 Select the model.

Select the model with air flow capacity exceeding the calculated corrected air flow from data (D) of the table below.

IDFB Selection Example

Condition	Data symbol	Correction factor*1
Inlet air temperature	110°F (A)	0.78
Ambient temperature	110°F (B)	0.78
Inlet air pressure	90 psi (C)	0.93
Air flow rate	130 SCFM	—
Outlet air pressure dew point	37°F	—

*1 Values obtained from the table below

$$\begin{aligned} \text{Corrected air flow capacity} \\ &= 130 \text{ SCFM} \div (0.78 \times 0.78 \times 0.93) \\ &= 230 \text{ SCFM} \end{aligned}$$

The model which exceeds the correct air flow capacity of 230 SCFM is IDFB80.

Data (A): Inlet Air Temperature

°F	80	90	100	110	120	130	140	149
°C	27	32	37.8	43	49	54	60	65
IDFB60/IDFB70	1.33	1.21	1.00	0.78	0.61	0.48	0.38	0.28
IDFB80/IDFB90	1.38	1.38	1.00	0.83	0.63	0.50	0.45	0.37

Data (B): Ambient Temperature

°F	80	90	100	110	113
°C	27	32	37.8	43	45
IDFB60/IDFB70	1.16	1.11	1.00	0.78	0.71
IDFB80/IDFB90	1.40	1.22	1.00	0.88	0.83

Data (C): Inlet Air Pressure

psi	50	60	70	80	90	100	120	140	145 to 232
MPa	0.35	0.41	0.48	0.55	0.62	0.69	0.83	0.97	1.00 to 1.60
IDFB60/IDFB70	0.71	0.77	0.82	0.87	0.93	1.00	1.09	1.20	1.22
IDFB80/IDFB90	0.77	0.82	0.86	0.90	0.94	1.00	1.07	1.16	1.18

Data (D): Air Flow Capacity

Model		Air flow capacity SCFM (m ³ /h (ANR))			
		IDFB60	IDFB70	IDFB80	IDFB90
Outlet air pressure dew point	37°F (2.8°C)	113 (192)	166 (282)	247 (420)	335 (570)
	45°F (7.2°C)	155 (264)	215 (366)	314 (534)	406 (690)
	50°F (10°C)	177 (300)	251 (426)	353 (600)	459 (780)

* The outlet air pressure dew point varies depending on the operating conditions. Particularly when the outlet air pressure dew point is 37°F or 45°F, though this depends on the operating conditions, freeze protection functions may be activated, resulting in the dew point rising and becoming unstable. If a stable low dew point is required, consider an IDG series membrane air dryer.

* Refer to page 181 for options.

* Refer to page 180 for optional accessories.

Refrigerated Air Dryer

IDFB60/70/80/90 Series

Max. inlet air temperature: 149°F (65°C), Max. ambient temperature: 113°F (45°C)

How to Order

IDFB **60** - **23** **N** -

● **Size**

60
70
80
90

● **Voltage**

Symbol	Voltage
23	Single-phase 230 VAC (60 Hz)
11	Single-phase 115 VAC (60 Hz)*1

*1 IDFB60 only

● **Thread type**

Symbol	Thread type	Drain tube size
N	NPT (male)	O.D. 1/2 inch
Nil	R (male)	O.D. 12 mm

● **Options**

Symbol	Description
Nil	None
C	Anti-corrosive treatment for copper tube
L	With a heavy-duty auto drain [The maximum operating pressure is 232 psi (1.6 MPa).]
R	With an earth leakage breaker
T	With a terminal block for operating, error, and remote operation signals
V	With a timer controlled solenoid valve type auto drain [The maximum operating pressure is 232 psi (1.6 MPa).]

* When multiple options are combined, indicate symbols in alphabetical order.

* The combination of L and V is not available.

Replacement Parts

Auto drain

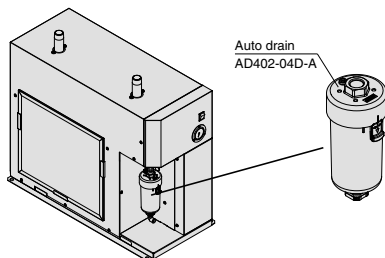

Auto Drain Replacement Part Nos.

Description	Part no.	Qty.
Element	AD402P-040S	1
Bowl O-ring	KA00463	1
Bowl assembly*1	AD52-A	1

*1 A bowl O-ring is included.

A One-touch fitting for connecting the drain tube is not included.

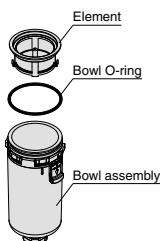

Dustproof filter

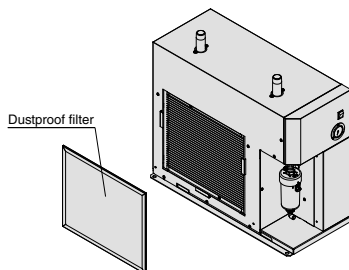

Dustproof Filter Replacement Part Nos.

Part no.	Qty.	Dimension [inch (mm)]	Applicable model
IDF-S0530	1	H14.6 x W17.3 (H370 x W440)	For IDFB60
IDF-S0531	1	H24.2 x W17.3 (H614 x W440)	For IDFB70
IDF-S0535	1	H24.2 x W21.9 (H614 x W556)	For IDFB80, IDFB90

Standard Specifications



Specifications		Model	IDFB60 -11	IDFB60 -23	IDFB70 -23	IDFB80 -23	IDFB90 -23
Operating range ^{*1}	Fluid		Compressed air				
	Inlet air temperature		41 to 149 (5 to 65)				
	Inlet air pressure		22 to 150 (0.15 to 1.0) ^{*8}				
	Ambient temperature (Humidity)		36 to 113 (2 to 45) (Relative humidity: 85% or less)				
Rated conditions ^{*3}	Air flow capacity ^{*2} [SCFM (m ³ /h)]	Outlet air pressure dew point	37°F (2.8°C)	113 (192)	166 (282)	247 (420)	335 (570)
		Outlet air pressure dew point	45°F (7.2°C)	155 (264)	215 (366)	314 (534)	406 (690)
		Outlet air pressure dew point	50°F (10°C)	177 (300)	251 (426)	353 (600)	459 (780)
	Inlet air pressure		[psi (MPa)]	100 (0.7)			
	Inlet air temperature		[°F (°C)]	100 (37.8)			
	Ambient temperature		[°F (°C)]	100 (37.8)			
Power supply voltage (Frequency) ^{*4}		Single-phase 115 VAC (60 Hz)	Single-phase 230 VAC (60 Hz)				
Maximum air flow capacity		Air flow capacity calculated with the correction factors					
Electric spec.	Power consumption ^{*5}		[W]	1100	1870	2490	3630
	Current consumption ^{*5}		[A]	10.0	4.8	8.2	10.9
Applicable earth leakage breaker capacity (Sensitivity current 30 mA) ^{*6}		[A]	15	10	15	20	30
Cooling method		Air-cooled refrigeration					
Refrigerant		R410A (HFC) GWP: 2088 ^{*7}					
Refrigerant charge		[oz (g)]	13.7 ±0.4 (390 ±10)	18.7 ±0.4 (530 ±10)	22.2 ±0.4 (630 ±10)	27.5 ±0.4 (780 ±10)	
Auto drain		Float type (Normally open, Min. operating pressure: 14.5 psi (0.1 MPa))					
Port size	Symbol N	NPT1		NPT1 1/2		NPT2	
	Symbol Nil	R1		R1 1/2		R2	
Drain tube O.D.	Symbol N	1/2 inch					
	Symbol Nil	12 mm					
Weight		[lbs (kg)]	108 (49)	150 (68)	209 (95)	243 (110)	
Accessories		Drain tube (Length: 3.5 m) (O.D.: 1/2 inch [Thread symbol: N], 12 mm [Thread symbol: Nil]) Drain tube holder, Operation manual					
Compliant standards		UL, CSA					

Symbol

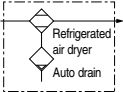

- *1 The operating range does not guarantee use with normal air flow capacity.
- *2 Air flow capacity under the standard condition (ANR) [atmospheric pressure 68°F (20°C), relative humidity 65%].
- *3 When the operating conditions are different from the rated values, select a model in accordance with Model Selection (page 177) or calculate the air flow capacity suitable to the operating conditions based on the Correction of Air Flow Capacity.
- *4 Do not use this product with continuous voltage fluctuations.
- *5 These values are reference values under rated conditions and are not guaranteed. Do not use these values for the thermal relay set values, etc.
- *6 Products other than Option R are not equipped with an earth leakage breaker. Purchase an appropriate earth leakage breaker separately. Use an earth leakage breaker with a leak current sensitivity of 30 mA.
- *7 This is the value specified by IPCC4 AR4. The value specified by the Revised Fluorocarbons Recovery and Destruction Law (Japanese law) is R410A GWP: 2090.
- *8 The maximum operating pressure is 1.0 MPa as standard, but it is possible to achieve 232 psi (1.6 MPa) when selecting Option L or Option V.

Correction of Air Flow Capacity

Inlet air temperature [°C]

°F	80	90	100	110	120	130	140	149
°C	27	32	37.8	43	49	54	60	65
IDFB60/IDFB70	1.33	1.21	1.00	0.78	0.61	0.48	0.38	0.28
IDFB80/IDFB90	1.38	1.38	1.00	0.83	0.63	0.50	0.45	0.37

Ambient temperature [°C]

°F	80	90	100	110	113
°C	27	32	37.8	43	45
IDFB60/IDFB70	1.16	1.11	1.00	0.78	0.71
IDFB80/IDFB90	1.40	1.22	1.00	0.88	0.83

Inlet air pressure [MPa]

psi	50	60	70	80	90	100	120	140	145 to 232
MPa	0.35	0.41	0.48	0.55	0.62	0.69	0.83	0.97	1.00 to 1.60
IDFB60/IDFB70	0.71	0.77	0.82	0.87	0.93	1.00	1.09	1.20	1.22
IDFB80/IDFB90	0.77	0.82	0.86	0.90	0.94	1.00	1.07	1.16	1.18

Calculation example: The air flow capacity when the dew point of the IDFB60 is set to 50°F under the following conditions is calculated. [Operating conditions: Inlet air temperature: 100°F, Ambient temperature: 90°F, Inlet air pressure: 90 psi] 177 SCFM x 1.00 x 1.11 x 0.93 = 183 SCFM

IDFB Series

Construction (Air/Refrigerant Circuit)

Humid, hot air coming into the air dryer will be cooled down by a cooler re-heater (heat exchanger). Water condensed at this time will be removed from the air by an auto drain and drained out automatically. Air separated from the water will be heated by a cooler re-heater (heat exchanger) to obtain the dried air, which goes through to the outlet side.

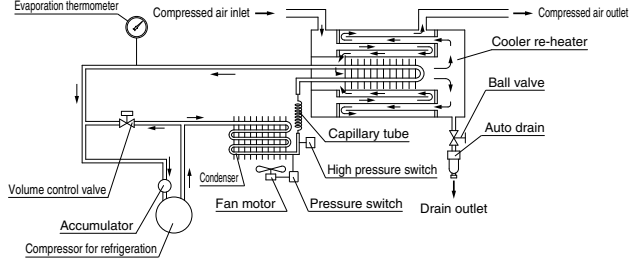

Dimensions

IDFB60, 70, 80, 90

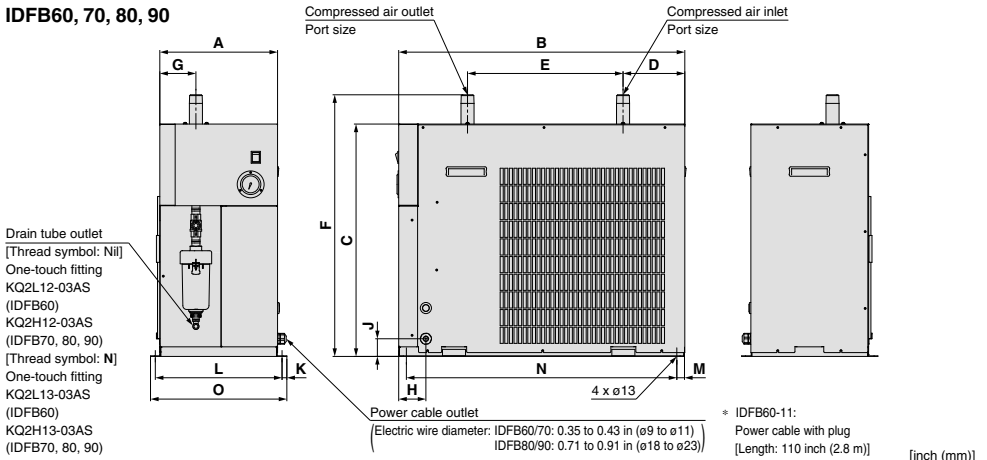

Model	Port size	A	B	C	D	E	F	G	H	J	K	L	M	N	O
IDFB60	1	12.1 (307)	29.3 (745)	23.8 (605)	6.3 (161)	15.9 (405)	26.8 (681)		2.8 (71)			13.0 (330)		27.7 (704)	14.0 (355)
IDFB70	1 1/2	13.5 (342)	35.0 (890)	32.5 (825)	6.9 (176)	18.9 (480)	35.6 (905)	3.7 (94)	2.7 (68)	1.8 (46)	0.5 (13)	14.4 (365)	0.8 (20)	33.4 (849)	15.4 (390)
IDFB80	2	17.2 (438)	37.7 (957)	34.0 (863)	6.7 (169)	18.9 (480)	37.7 (958)	8.6 (219)	3.1 (78)	3.9 (100)	0.4 (11)	18.2 (463)		36.1 (916)	19.1 (485)
IDFB90															

Optional Accessories

[Foundation bolt set]

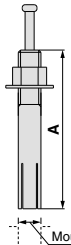

For fixing the air dryer to the foundations.
Easy to secure by striking the axle.

Mounting hole dia.: ø10.5

Part no.	Nominal thread size	Material	Number of 1 set	A
IDF-AB500	M10	Stainless steel	4	1.97 (50)

[Piping adapter]

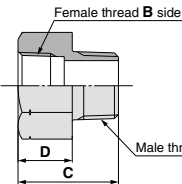
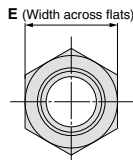

For converting the thread type of an IN/OUT fitting for air dryers.

Part no.	Thread type and port size	C	D	E	Material	Number of 1 set
IDF-AP604	NPT1 Male thread A side Rc1 Female thread B side	1.97 (50)	1.06 (27)	1.81 (46)	Brass	2
IDF-AP606	NPT1 1/2 Male thread A side Rc1 1/2 Female thread B side	2.17 (55)	1.22 (31)	2.13 (54)		
IDF-AP607	NPT2 Male thread A side Rc2 Female thread B side	2.56 (65)	1.18 (30)	2.76 (70)		

IDFB Series Options

C Option symbol Anti-corrosive treatment for copper tube

This minimizes the corrosion of the copper and copper alloy parts when the air dryer is used in an atmosphere containing hydrogen sulfide or sulfurous acid gas. (Corrosion cannot be completely prevented.)
Special epoxy coating: Copper tube and copper alloy parts. The coating is not applied on the heat exchanger or around electrical parts, where operation may be affected by the coating.

* Failure due to corrosion is not covered under warranty.

L Option symbol With a heavy-duty auto drain (applicable to moderate pressure)

The float type auto drain used in the standard air dryer is replaced with a heavy-duty auto drain (ADH4000-04) which enables the condensate to discharge more efficiently. The product can be used for moderate pressure with this option.
Max. operating pressure: 232 psi (1.6 MPa)

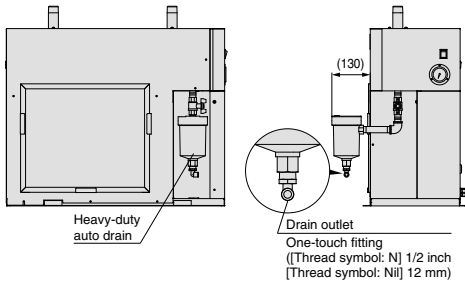

* The heavy-duty auto drain and piping materials (nipple, elbow) are shipped together with the main body of the air dryer. Customers are required to mount the parts to the air dryer.

Replacement Parts: Heavy-Duty Auto Drain

Replacement part no. (Description)	Configuration
ADH4000-04 (Heavy-duty auto drain)	Heavy-duty auto drain
ADH-E400 (Replacement kit for exhaust mechanism)	Replacement kit for exhaust mechanism
	Housing (Use existing equipment.)

R Option symbol With an earth leakage breaker

The air dryer is equipped with an earth leakage breaker, reducing the electrical wiring required during installation.

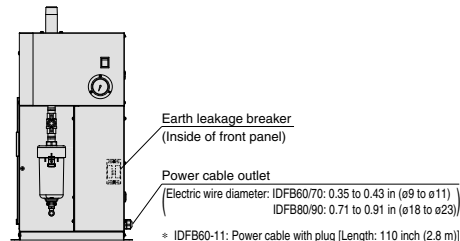

* IDFB60-11: Power cable with plug [Length: 110 inch (2.8 m)]

T Option symbol With a terminal block for operating, error, and remote operation signals

In addition to power supply connection, terminal blocks for operating, error, and remote operation signals are available.

• The operating and error signals are no-voltage contact style.

Operating signal...During operation: contact "close", During stop: contact "open"

Error signal...During error: contact "close", During stop: contact "open"

Contact capacity...Rated load voltage: 240 VAC or less/24 VDC or less

Max. load current: 5 A (Resistance load)/2 A (Induction load)

Min. applicable load: 20 VDC, 3 mA

• Power supply voltage is applied to the remote operation contact. The external switch is to be prepared by customers. Position holding switch (alternate type switch) or automatic return switch (momentary switch) can be used.

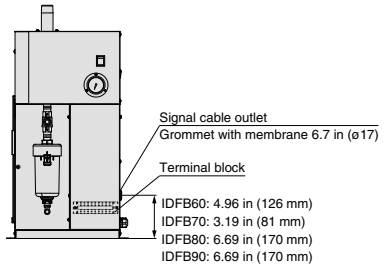

V Option symbol With a timer controlled solenoid valve type auto drain (applicable to moderate pressure)

Drainage is discharged by controlling a solenoid valve with a timer.

A strainer for solenoid valve protection and a stop valve are also included.

Maximum operating pressure: 232 psi (1.6 MPa)

Replacement Parts

Part no.	Note
IDF-S0534	200 VAC to 230 VAC
IDF-S1966	115 VAC

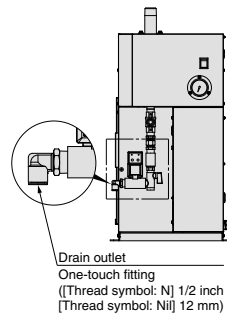

Specific Product Precautions 1

Be sure to read this before handling the products. For safety instructions and air preparation equipment precautions, refer to the “Handling Precautions for SMC Products” and the “Operation Manual” on the SMC website: <https://www.smcworld.com>



Installation

⚠ Caution

- Avoid locations where the air dryer will be in direct contact with wind or rain. (Avoid locations where relative humidity is 85% or more.)
- Avoid locations where water, water vapor, salt water, or oil may splash on the product.
- Avoid locations where dust or other particles are present.
- Avoid locations where flammable or explosive gases are present.
- Avoid locations where corrosive gases, solvents, or combustible gases are present.
- Avoid locations which receive direct sunlight or radiated heat.
- Avoid locations where the ambient temperature exceeds the limits as mentioned below.
During operation: 36°F (2°C) to 113°F (45°C)
During storage: 32°F (0°C) to 122°F (50°C) (when there is no drain water inside of the piping)
- Avoid locations where temperature substantially changes.
- Avoid locations where strong magnetic noise occurs. (Avoid locations where strong electric fields, strong magnetic fields, or surge voltages occur.)
- Avoid locations where static electricity occurs or conditions which make the product discharge static electricity.
- Avoid locations where high frequencies occur.
- Avoid locations where damage is likely to occur due to lightning.
- Avoid installation on machines used for transporting, such as vehicles, ships, etc.
- Avoid locations at altitudes of 6562 feet (2000 meters) or higher.
- Avoid locations where strong impacts or vibrations occur.
- Avoid conditions where a massive force strong enough to deform the product is applied or the weight from a heavy object is applied.
- Avoid locations with insufficient space for maintenance.
- Avoid locations where the ventilation grille is obstructed.
- Avoid locations where the air dryer will draw in high-temperature air discharged from an air compressor or other dryer.

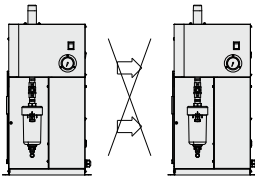

Confirm that the exhaust air does not flow into the neighboring equipment.

- Avoid pneumatic circuits where rapid pressure fluctuations or flow speed changes are generated.
- When installing in locations where the dripping of condensation is a problem. Depending on the operating conditions, the product and its downstream pipes could drip water due to condensation formed by supercooling. If this is a problem, install a drain receiver below this product or the condensation points and empty it regularly. Alternatively, wind additional insulation around the condensation points.

Drain Tube

⚠ Caution

- A tube with an outside diameter of 0.47 in (12 mm) is attached as a drain tube. Use this tube to discharge condensate to a drain tank, etc.
- Do not use the drain tube in an upward direction. Do not bend or crush the drain tube. If it is unavoidable that the tube goes upward, make sure it only goes as far as the position of the auto drain outlet. The drain tube to be prepared should have an O.D. of 0.47 in (12 mm), an I.D. of 0.31 in (8 mm) or more, and be 16.4 ft (5 m) or less in length. Otherwise, the auto drain will not operate correctly, which may cause air to be blown constantly or moisture not to be exhausted.

Power Supply

⚠ Caution

- Connect the power supply to the terminal block.
 - Install an earth leakage breaker*1 suitable to each model for the power supply.
 - Maintain a voltage range within $\pm 10\%$ of the rated voltage. (Do not use this product with continuous voltage fluctuations.)
- *1 Select an earth leakage breaker with a leak current sensitivity of 30 mA.
Regarding the rated current, refer to the Applicable Earth Leakage Breaker Capacity.
- When a short-term interruption of the power supply (including momentary interruptions) occurs in this equipment, the restarting of normal operations may require some time or may be impossible due to the operation of protective devices even after the supply of power returns.

Air Piping

⚠ Caution

- Be careful to avoid any errors in connecting the air piping at the compressed air inlet (IN) and outlet (OUT).
- Flush the piping sufficiently in order to avoid any foreign matter such as dust, sealant tape, liquid gasket, etc., before connecting piping. Foreign matter in the piping can cause cooling failure or drainage failure.
- Inlet and outlet compressed air connections should be made removable by using a union, etc.
- Provide bypass piping to make it possible to do maintenance without stopping the air compressor.
- When tightening the inlet/outlet air piping, firmly hold the port on the air dryer with a pipe wrench, etc.
- Use pipes and fittings that can endure the operating pressure and temperature. Connect them firmly to prevent air leakage.
- Do not allow the load of the piping to lie directly on the air dryer. When mounting any part, such as an air filter, on the fitting at the compressed air inlet or outlet port, support the part to prevent excessive force from being applied to the product.
- Be careful not to let the vibrations of the air compressor transmit.
- If a metallic flexible tubing is used for the inlet/outlet air piping, abnormal noise might be generated in the piping. In such cases, please use steel tubing instead.
- If the temperature of the compressed air on the inlet side is over 149°F (65°C), place an aftercooler after the air compressor. Or, lower the temperature of the place where the air compressor is installed to below 149°F (65°C).
- If the air supply generates high pressure fluctuations (pulsations), take appropriate countermeasures, such as installing an air tank.
- If rapid pressure fluctuations or flow changes occur, install a filter on the dryer outlet to prevent condensate from splashing.
- Variations in operating conditions may cause condensation to form on the surface of the outlet piping. Apply thermal insulation around the piping to prevent condensation from forming.

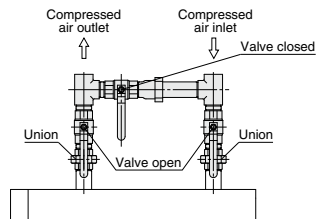



IDFB Series

Specific Product Precautions 2

Be sure to read this before handling the products. For safety instructions and air preparation equipment precautions, refer to the “Handling Precautions for SMC Products” and the “Operation Manual” on the SMC website: <https://www.smcworld.com>

Protection Circuit

Caution

When the air dryer is operated in the following cases, the protection circuit will activate, the light will turn off and the air dryer will come to stop.

- The compressed air temperature is too high.
- The compressed air flow rate is too high.
- The ambient temperature is too high. (113°F (45°C) or higher)
- The fluctuation of the power supply voltage is beyond ±10% of the rated voltage.
- The air dryer is drawing in high temperature air exhausted from an air compressor or other dryer.
- The ventilation grille is obstructed by a wall or clogged with dust.

Transportation and Installation

Warning

Be sure to follow the instructions below for transporting the product.

- The product is filled with refrigerant. Transport it (by land, sea or air) in accordance with laws and regulations specified.
- When carrying the product, be careful not to let it drop or fall over, and use a forklift.
- Do not lift the product by holding the panel, fittings or piping.
- Never lay the product down for transportation. This may lead to damage to the product.

- The product is heavy and has potential dangers in transportation. Be sure to follow the instructions above.
- Be sure to use a forklift for transporting the product. Weight of each model with packaging: IDFB60: 126 lbs (57 kg), IDFB70: 172 lbs (78 kg), IDFB80: 234 lbs (106 kg), IDFB90: 269 lbs (122 kg)

Compressor Air Delivery

Caution

Since the auto drain is designed in such a way that the valve remains open unless the air pressure rises to 14.5 psi (0.1 MPa) or higher, air will blow out from the drain outlet at the time of air compressor start up until the pressure increases. Therefore, if an air compressor has a small air delivery, the pressure may not be sufficient.

Auto Drain

Caution

The auto drain may not function properly, depending on the quality of the compressed air. Check the operation once a day.

Cleaning of Ventilation Area

Caution

If the dustproof filter becomes clogged with dust or debris, a decline in cooling performance can result.

In order to avoid deforming or damaging the dustproof filter, clean it with a long-haired brush or air gun once a month.

Time Delay for Restarting

Caution

Allow at least three minutes before restarting the air dryer. Otherwise, the protection circuit will activate, the light will turn off and the air dryer will not start up.

Modifying the Standard Specifications

Caution

Do not modify the standard product using any of the optional specifications once the product has been supplied to a customer. Check the specifications carefully before selecting an air dryer.

In addition, do not disassemble or modify the product. Products which have been disassembled and/or modified cannot be guaranteed.

■ Refrigerant with GWP Reference

Refrigerant	Global Warming Potential (GWP)		
	Regulation (EU) No 517/2014 (Based on the IPCC AR4)	Fluorocarbon Emissions Control Act (Japan) GWP value labeled on products	Fluorocarbon Emissions Control Act (Japan) GWP value to be used for reporting the calculated amount of leakage
R134a	1430	1430	1300
R404A	3922	3920	3940
R407C	1774	1770	1620
R410A	2088	2090	1920

- * This product is hermetically sealed and contains fluorinated greenhouse gases (HFC). When this product is sold on the market in the EU after January 1, 2017, it needs to be compliant with the quota system of the F-Gas Regulation in the EU.
- * See specification table for refrigerant used in the product.