

# Finger Valve

# VHK-A Series

RoHS

With a function to prevent the knob from coming out

Large effective area: 2.0 to 17.5 mm<sup>2</sup>

Reduced operating force

Poppet valve construction seldom suffers seal deflection.

The series begins with the min. tubing O.D. of  $\phi 4$ .

Selection from four types in accordance with the piping specifications

The 3-port valve discharges residual pressure from 2(A) with the handle set at SHUT. (There is no exhaust port.)

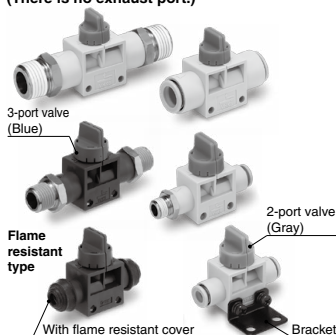

The valve direction clearly indicates whether the valve is open or closed. (SHUT-OPEN: Counterclockwise)

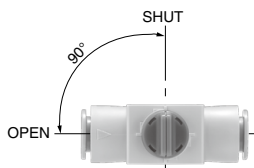

2-port valves and 3-port valves can be distinguished by the color of their knobs.

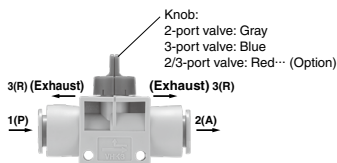

## Symbol

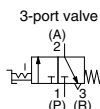
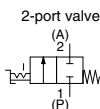

## Specifications

Valve	2/3-port valves
Fluid	Air
Proof pressure	1.5 MPa
Max. operating pressure <sup>Note 1)</sup>	1.0 MPa
Operating vacuum pressure*	-100 kPa
Ambient temperature and operating fluid temperatures	0 to 60°C
Applicable tubing material <sup>Note 2)</sup>	Nylon, Soft nylon, Polyurethane
Accessory (Option)	Bracket

Note 1) Please note that when the valve is used at micro pressures of 0.1 MPa or less, valve leakage may be more than the standard value (5 cm<sup>3</sup>/min).

Note 2) Use caution about the maximum operating pressure when soft nylon or polyurethane tubing is used. (Refer to the **Web Catalog** for details.)

\* Use VHK2 (2-port valve) for vacuum application.

## Construction

### 2-port valve: VHK2A series

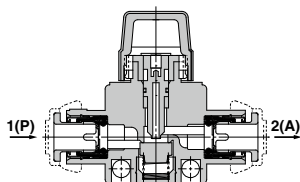

### 3-port valve: VHK3A series

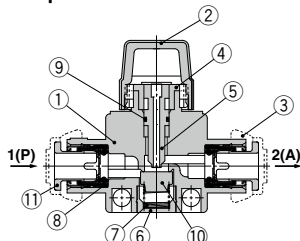

## Component Parts

No.	Description	Material	Note
1	Body	Standard type	PBT
		Flame resistant type	Flame resistant PBT (UL standard V-0)
2	Knob	Standard type	POM
		Flame resistant type	Flame resistant PBT (UL standard V-0)
3	Cover	Flame resistant CR (UL standard V-0)	Applicable to the flame-resistant cover only.
4	Cam ring	POM	
5	Stem	POM	
6	Spring guide	Brass	
7	Spring	Electroless nickel plated	
8	Seal	Stainless steel	
9	O-ring	NBR	
10	Valve	NBR	
11	Cassette	Standard type	POM
		Flame resistant type	Flame resistant PBT (UL standard V-0)

## Replacement Parts

Description	Model	
	<ul style="list-style-type: none"> <li>One-touch fitting</li> <li>Applicable tubing O.D. <math>\phi 8</math> or less</li> </ul>	<ul style="list-style-type: none"> <li>One-touch fitting</li> <li>Applicable tubing O.D. <math>\phi 10</math> or more</li> <li>1(P)-Male thread • 2(A)-Male thread</li> <li>Port size R3/8 or more</li> </ul>
	Part no.	
<b>Bracket assembly</b> <sup>Note 2)</sup>	VHK-B1A <sup>Note 1)</sup>	VHK-B2A <sup>Note 1)</sup>

Note 1) For details on selection of each bracket assembly part no., refer to the tables on page 1506.

Note 2) The bracket, bolts, nuts, and washers are supplied with the bracket assembly.

## How to Order



**Standard type** VHK **2** A — **02S** — **02S** [ ] [ ] [ ]

**Flame resistant type** VHK **2** A R — **04F** — **04F** [ ] [ ] [ ] **• Made to order**

**Valve model**

2	2-port valve
3	3-port valve

**Flame resistant type**

**1(P) port size**

04F	ø4
06F	ø6
08F	ø8
10F	ø10
12F	ø12
M5	M5 x 0.8
01S	R 1/8
02S	R 1/4
03S	R 3/8
04S	R 1/2

**Bracket**

Nil	None
L	With L-bracket

\* Bracket and screws are attached.

**Flame resistant cover**

Nil	None
C	With cover (For One-touch fitting only)

**Knob color**

Nil (Standard)	2-port valve	Gray
	3-port valve	Blue
R (Option)	2-port valve	Red
	3-port valve	

**2(A) port size**

04F	ø4
06F	ø6
08F	ø8
10F	ø10
12F	ø12
M5	M5 x 0.8
01S	R 1/8
02S	R 1/4
03S	R 3/8
04S	R 1/2

## Standard Type

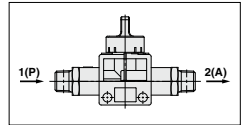
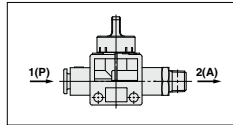
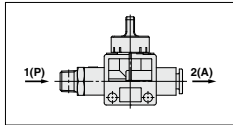
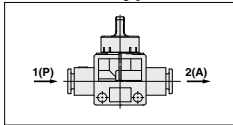

**1(P): One-touch fitting**  
**2(A): One-touch fitting**

	2(A)	Applicable tubing O.D. (mm)				
1(P)	ø4	ø4	ø6	ø8	ø10	ø12
Applicable tubing O.D. (mm)	ø4	●				
	ø6		●			
	ø8			●		
	ø10				●	●
	ø12					●

**1(P): Male thread**  
**2(A): One-touch fitting**

	2(A)	Applicable tubing O.D. (mm)				
1(P)	ø4	ø6	ø8	ø10	ø12	
Port size R	M5	●	●			
	1/8	●	●	●		
	1/4		●	●	●	
	3/8		●	●	●	●
	1/2			●	●	●

**1(P): One-touch fitting**  
**2(A): Male thread**

	2(A)	Port size R				
1(P)	M5	1/8	1/4	3/8	1/2	
Applicable tubing O.D. (mm)	ø4	●	●			
	ø6		●	●		
	ø8		●	●	●	
	ø10			●	●	●
	ø12				●	●

**1(P): Male thread**  
**2(A): Male thread**

	2(A)	Port size R				
1(P)	M5	1/8	1/4	3/8	1/2	
Port size R	M5	●				
	1/8	●	●			
	1/4		●	●		
	3/8			●	●	
	1/2				●	●

## Flame Resistant Type (UL-94 Standard V-0 equivalent)

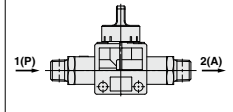
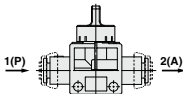

**1(P): One-touch fitting**  
**2(A): One-touch fitting**

	2(A)	Applicable tubing O.D. (mm)				
1(P)	ø4	ø6	ø8	ø10	ø12	
Applicable tubing O.D. (mm)	ø4	●				
	ø6		●			
	ø8			●		
	ø10				●	
	ø12					●

**1(P): Male thread**  
**2(A): Male thread**

	2(A)	Port size R			
1(P)	1/8	1/4	3/8	1/2	
Port size R	1/8	●			
	1/4		●		
	3/8			●	
	1/2				●

# VHK-A Series

## 1(P)/2(A): One-touch Fitting

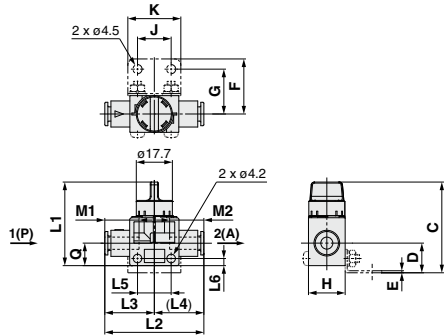
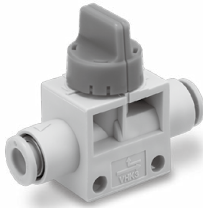

Applicable tubing O. D. (mm)		Model	H	L1	L2	L3	L4	L5	L6	M1	M2	Q	Flow rate characteristics						Weight (g)	Bracket mounting dimensions											
1(P)	2(A)												1(P)→2(A)			2(A)→3(R)*1				Bracket assembly no.		C	D	E	F	G	J	K			
													Q <sub>opt</sub> (l/min)	b	Cv	Q <sub>opt</sub> (l/min)	b	Cv													
4	4	VHK□A-04F-04F	18	41	47.6	23.8	23.8	16.5	3.5	15.8	15.8	11	0.7	0.15	0.14	0.25	0.6	0.06	15	VHK-B1A	44.5	14.5	1	27	22	16.5	26				
		VHK□A-06F-04F	18	41	48	24.3	24.3	16.5	3.5	16.8	16.8	11	1.0	0.15	0.21	0.25	0.6	0.06	15	VHK-B1A	44.5	14.5	1	27	22	16.5	26				
6	6	VHK□A-06F-06F	18	41	48.6	24.3	24.3	16.5	3.5	16.8	16.8	11	1.4	0.15	0.35	0.25	0.6	0.06	16	VHK-B1A	44.5	14.5	1	27	22	16.5	26				
		VHK□A-08F-06F	18	41	50.5	26.2	24.3	16.5	3.5	18.7	16.8	11	2	0.15	0.36	0.25	0.6	0.06	16	VHK-B1A	44.5	14.5	1	27	22	16.5	26				
8	8	VHK□A-08F-08F	18	41	52.4	26.2	26.2	16.5	3.5	18.7	18.7	11	1.9	0.15	0.39	0.25	0.6	0.06	17	VHK-B1A	44.5	14.5	1	27	22	16.5	26				
		VHK□A-10F-08F	22	46	58.5	30.5	28	21.5	4	20.8	18.7	14	2.7	0.15	0.55	0.67	0.6	0.16	28	VHK-B2A	49	17	1	30	25	21.5	31				
10	10	VHK□A-10F-10F	22	46	61	30.5	30.5	21.5	4	20.8	20.8	14	3.1	0.15	0.65	0.67	0.6	0.16	29	VHK-B2A	49	17	1	30	25	21.5	31				
		VHK□A-12F-10F	22	46	62	31.5	30.5	21.5	4	21.8	20.8	14	3.3	0.15	0.68	0.67	0.6	0.16	31	VHK-B2A	49	17	1	30	25	21.5	31				
12	12	VHK□A-12F-12F	22	46	63	31.5	31.5	21.5	4	21.8	21.8	14	3.4	0.15	0.70	0.67	0.6	0.16	32	VHK-B2A	49	17	1	30	25	21.5	31				

\*1 3-port valve

## 1(P): Male Thread, 2 (A): One-touch Fitting

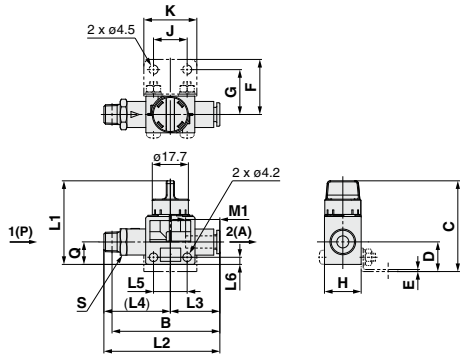
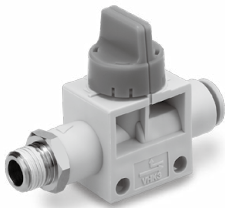

Connection thread R		Applicable tubing O. D. (mm)	Model	H	L1	L2	L3	L4	L5	L6	M1	Q	Flow rate characteristics						Weight (g)	S (Width across flats)	Bracket mounting dimensions											
1(P)	2(A)												1(P)→2(A)			2(A)→3(R)*1					Bracket assembly no.		C	D	E	F	G	J	K			
													Q <sub>opt</sub> (l/min)	b	Cv	Q <sub>opt</sub> (l/min)	b	Cv														
M5	4	VHK□A-M5-04F	18	41	52.9	23.8	29.1			16.5	3.5	15.8	11	0.4	0.15	0.10	0.25	0.6	0.06	19	49	11	VHK-B1A	44.5	14.5	1	27	22	16.5	26		
		VHK□A-M5-06F	18	41	53.9	24.3	29.6			16.8	3.5	16.8	11	0.4	0.15	0.10	0.25	0.6	0.06	21	50	13	VHK-B1A	44.5	14.5	1	27	22	16.5	26		
1/8	4	VHK□A-01S-04F	18	41	55.4	23.8	31.6			15.8	3.5	16.8	11	0.7	0.15	0.17	0.25	0.6	0.06	21	51	11	VHK-B1A	44.5	14.5	1	27	22	16.5	26		
		VHK□A-01S-06F	18	41	56.9	24.3	32.6			16.5	3.5	16.8	11	1.4	0.15	0.35	0.25	0.6	0.06	23	53	13	VHK-B1A	44.5	14.5	1	27	22	16.5	26		
1/4	6	VHK□A-02S-06F	18	41	62.2	26.2	36			18.7	3.5	18.7	11	1.9	0.15	0.47	0.25	0.6	0.06	31	58	17	VHK-B1A	44.5	14.5							
		VHK□A-02S-08F	18	41	60.4	24.3	36.1			16.8	3.5	16.8	11	1.4	0.15	0.35	0.25	0.6	0.06	31	54	14	VHK-B1A	44.5	14.5							
	8	VHK□A-02S-06F	22	46	65.2	26.2	39			18.7	3.5	18.7	11	1.9	0.15	0.47	0.25	0.6	0.06	32	59	17	VHK-B1A	44.5	14.5	1						
		VHK□A-02S-10F	22	46	73.8	30.5	43.3			20.8	4	20.8	14	3.1	0.15	0.78	0.67	0.6	0.16	49	68	19	VHK-B2A	49	17							
3/8	6	VHK□A-03S-06F	18	41	76.3	31.5	44.8			21.8	4	21.8	14	3.4	0.15	0.85	0.67	0.6	0.16	63	70	22	VHK-B2A	49	17							
		VHK□A-03S-08F	18	41	62.4	24.3	38.1			16.8	3.5	16.8	11	1.4	0.15	0.35	0.25	0.6	0.06	41	56	17	VHK-B1A	44.5	11.5							
	8	VHK□A-03S-06F	22	46	66.2	26.2	40			18.7	3.5	18.7	11	1.9	0.15	0.47	0.25	0.6	0.06	40	60	22	VHK-B1A	44.5	11.5	1						
		VHK□A-03S-10F	22	46	74.8	30.5	44.3			20.8	4	20.8	14	3.1	0.15	0.78	0.67	0.6	0.16	51	68	19	VHK-B2A	49	17							
1/2	10	VHK□A-03S-12F	22	46	77.3	31.5	45.8			21.8	4	21.8	14	3.4	0.15	0.85	0.67	0.6	0.16	64	71	22	VHK-B2A	49	17							
		VHK□A-04S-10F	22	46	78.2	30.5	47.7			20.8	4	20.8	14	3.1	0.15	0.78	0.67	0.6	0.16	72	70	22	VHK-B2A	49	17	1						
1/2	12	VHK□A-04S-12F	22	46	80.2	31.5	48.7			21.8	4	21.8	14	3.4	0.15	0.85	0.67	0.6	0.16	70	72	22	VHK-B2A	49	17	1						

\*1 3-port valve \*2 Reference dimensions after insertion of R thread.

**1(P): One-touch Fitting, 2(A): Male Thread**

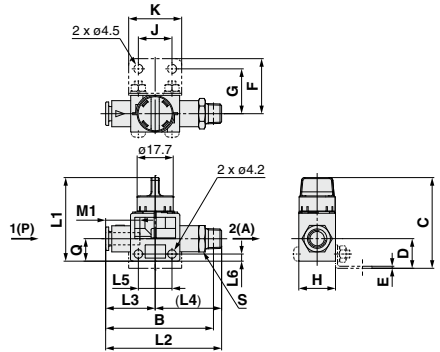
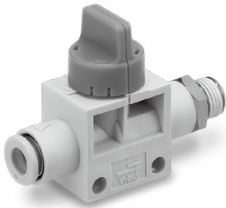

Applicable tubing O. D. (mm)	Connection thread R	Model	H	L1	L2	L3	L4	L5	L6	M1	Q	Flow rate characteristics						Weight (g)	+2 B	S (Width across flats)	Bracket mounting dimensions											
												1(P)→2(A)			2(A)→3(R)*1						Cv	b	Cv	b	Cv	C	D	E	F	G	J	K
												Q <sub>min</sub> (l/min)	b	Cv	Q <sub>min</sub> (l/min)	b	Cv															
4	M5	VHK□A-04F-M5	18	41	52.9	29.1			16.5	3.5	15.8	11	0.4	0.15	0.08	0.25	0.6	0.08	19	49	11	VHK-B1A	44.5	14.5	1	27	22	16.5	26			
	1/8	VHK□A-04F-01S	55.4	23.8	31.6								0.7	0.15	0.14	0.25	0.6	0.08	21	51	11											
6	M5	VHK□A-06F-M5	18	41	53.9	29.6			16.5	3.5	16.8	11	0.4	0.15	0.08	0.25	0.6	0.08	21	50	13	VHK-B1A	44.5	14.5	1	27	22	16.5	26			
	1/8	VHK□A-06F-01S	56.9	32.6	36.1								1.4	0.15	0.35	0.25	0.6	0.08	23	53	13											
	1/4	VHK□A-06F-02S	60.4	24.3	38.1								1.4	0.15	0.29	0.25	0.6	0.08	31	54	14											
	3/8	VHK□A-06F-03S	62.4	38.1	36								1.9	0.15	0.29	0.25	0.6	0.08	41	56	17											
8	1/4	VHK□A-08F-02S	18	41	65.2	26.2	39	16.5	3.5	18.7	11	11	1.9	0.15	0.39	0.25	0.6	0.08	32	59	17	VHK-B1A	44.5	14.5	1	27	22	16.5	26			
	3/8	VHK□A-08F-03S	66.2	40	40								1.9	0.15	0.39	0.25	0.6	0.08	40	60												
	1/2	VHK□A-08F-04S	73.8	43.3	43.3								3.1	0.15	0.65	0.67	0.6	0.21	49				VHK-B2A	49	17	1	30	25	21.5	31		
	3/4	VHK□A-08F-05S	78.2	47.7	47.7								3.1	0.15	0.65	0.67	0.6	0.21	72	70	22											
10	1/4	VHK□A-10F-02S	22	46	74.8	30.5	44.3	21.5	4	20.8	14	14	3.1	0.15	0.65	0.67	0.6	0.21	51			VHK-B2A	49	17	1	30	25	21.5	31			
	3/8	VHK□A-10F-03S	76.3	44.8	44.8								3.4	0.15	0.70	0.67	0.6	0.21	63	70												
	1/2	VHK□A-10F-04S	78.2	47.7	47.7								3.1	0.15	0.65	0.67	0.6	0.21	72	70	22											
	3/4	VHK□A-10F-05S	85.1	40.8	40.8								2.7	0.15	0.56	0.67	0.6	0.16	65	73	19											
12	1/4	VHK□A-12F-02S	22	46	77.3	31.5	45.8	21.5	4	21.8	14	14	3.4	0.15	0.70	0.67	0.6	0.21	64	71	22	VHK-B2A	49	17	1	30	25	21.5	31			
	3/8	VHK□A-12F-03S	80.2	48.7	48.7								3.4	0.15	0.70	0.67	0.6	0.21	70	72												
	1/2	VHK□A-12F-04S											3.4	0.15	0.70	0.67	0.6	0.21	101	81												
	3/4	VHK□A-12F-05S											3.4	0.15	0.70	0.67	0.6	0.21	101	81												

\*1 3-port valve \*2 Reference dimensions after insertion of R thread.

**1(P)/2(A): Male Thread**

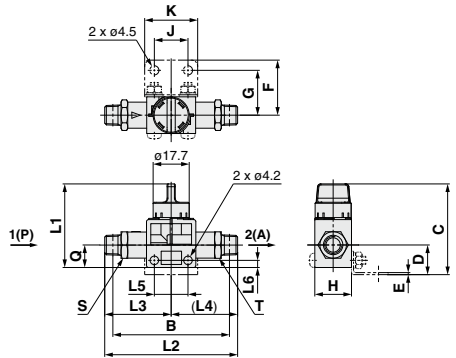
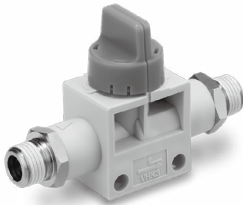

Connection thread R	2(A)	Model	H	L1	L2	L3	L4	L5	L6	Q	Flow rate characteristics						Weight (g)	+2 B	S (Width across flats)	T (Width across flats)	Bracket mounting dimensions											
											1(P)→2(A)			2(A)→3(R)*1							Cv	b	Cv	b	Cv	C	D	E	F	G	J	K
											Q <sub>min</sub> (l/min)	b	Cv	Q <sub>min</sub> (l/min)	b	Cv																
M5	M5	VHK□A-M5-M5	18	41	58.2	29.1			16.5	3.5	11	11	0.4	0.15	0.08	0.25	0.6	0.06	23	51	11	11	VHK-B1A	44.5	14.5	1	27	22	16.5	26		
1/8	M5	VHK□A-01S-M5	61.6	29.6	29								0.4	0.15	0.08	0.25	0.6	0.06	26	54	13	13										
1/4	1/8	VHK□A-01S-01S	65.2	32.6	32.6								1.6	0.15	0.35	0.25	0.6	0.06	30	62	13	13	VHK-B1A	44.5	14.5	1	27	22	16.5	26		
	1/4	VHK□A-02S-01S	71.6	39	39								1.8	0.15	0.37	0.25	0.6	0.06	39	62	13	13										
3/8	1/4	VHK□A-02S-02S	18	41	78	39	39	16.5	3.5	11	11	11	1.9	0.15	0.39	0.25	0.6	0.06	47	66	17	17	VHK-B1A	44.5	14.5	1	27	22	16.5	26		
	3/8	VHK□A-03S-02S	85.1	44.3	44.3								2.7	0.15	0.56	0.67	0.6	0.16	65	73	19	19										
	1/2	VHK□A-03S-03S	88.6	44.3	44.3								3.1	0.15	0.66	0.67	0.6	0.16	72	76	19	19										
	3/4	VHK□A-03S-04S	93	48.7	48.7								2.8	0.15	0.61	0.67	0.6	0.16	90	79	22	22										
1/2	3/8	VHK□A-04S-03S	22	46	93	44.3	44.3	21.5	4	14	14	14	3.4	0.15	0.71	0.67	0.6	0.16	90	79	22	22	VHK-B2A	49	17	1	30	25	21.5	31		
	1/2	VHK□A-04S-04S	97.4	48.7	48.7								3.4	0.15	0.71	0.67	0.6	0.16	101	81												

\*1 3-port valve \*2 Reference dimensions after insertion of R thread.

# VHK-A Series

## Flame Resistant Type: 1(P)/2(A): One-touch Fitting

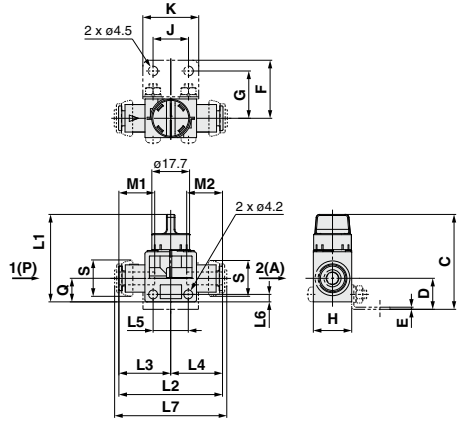
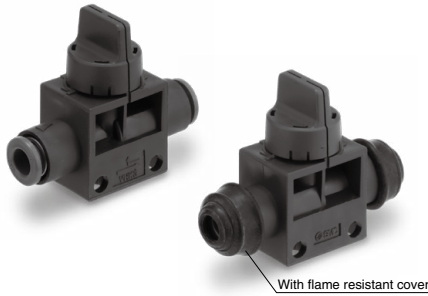

Applicable tubing O.D. (mm)	Model	H	L1	L2	L3	L4	L5	L6	L7	Q	M1	M2	Flow rate characteristics						Weight (g)	S	Bracket mounting dimensions										
													1(P) → 2(A)			2(A) → 3(R)					Bracket assembly no.			C	D	E	F	G	J	K	
1(P)	2(A)												C	b	Cv	C	b	Cv													
4	4	VHK□AR-04F-04F	18	41	47.6	23.8	23.8	16.5	3.5	51.6	11	15.8	15.8	0.4	0.15	0.14	0.25	0.6	0.08	15	ø14.4	VHK-B1A	44.5	14.5	1	27	22	16.5	26		
6	6	VHK□AR-06F-06F	18	41	48.6	24.3	24.3	16.5	3.5	52.6	11	16.8	16.8	1.4	0.15	0.35	0.25	0.6	0.08	16	ø16.8	VHK-B1A	44.5	14.5	1	27	22	16.5	26		
8	8	VHK□AR-08F-08F	18	41	52.4	26.2	26.2	16.5	3.5	56.4	11	18.7	18.7	1.9	0.15	0.39	0.25	0.6	0.08	17	ø19.2	VHK-B1A	44.5	14.5	1	27	22	16.5	26		
10	10	VHK□AR-10F-10F	22	46	61	30.5	30.5	21.5	4	65	14	20.8	20.8	3.1	0.15	0.65	0.67	0.6	0.21	29	ø23.3	VHK-B2A	49	17	1	30	25	21.5	31		
12	12	VHK□AR-12F-12F	22	46	63	31.5	31.5	21.5	4	67	14	21.8	21.8	3.4	0.15	0.70	0.67	0.6	0.21	32	ø25.7	VHK-B2A	49	17	1	30	25	21.5	31		

## Flame Resistant Type: 1(P)/2(A): Male Thread

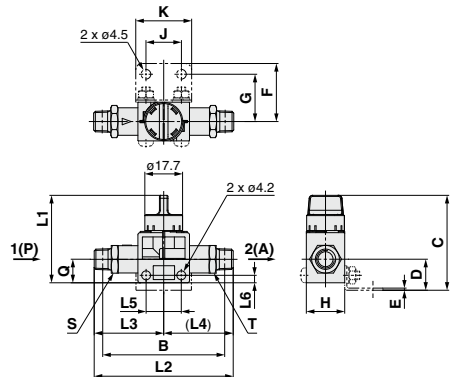

Connection thread R	Model	H	L1	L2	L3	L4	L5	L6	Q	B*	Flow rate characteristics						Weight (g)	S (Width across flats)	T (Width across flats)	Bracket mounting dimensions										
											1(P) → 2(A)			2(A) → 3(R)						Bracket assembly no.			C	D	E	F	G	J	K	
1(P)	2(A)										C	b	Cv	C	b	Cv														
1/8	1/8	VHK□AR-01S-01S	18	41	65.2	32.6	32.6	16.5	3.5	11	57	1.6	0.15	0.35	0.25	0.6	0.08	30	13	13	VHK-B1A	44.5	14.5	1	27	22	16.5	26		
1/4	1/4	VHK□AR-02S-02S	18	41	78	39	39	16.5	3.5	11	66	1.9	0.15	0.39	0.25	0.6	0.08	47	17	17	VHK-B1A	44.5	14.5	1	27	22	16.5	26		
3/8	3/8	VHK□AR-03S-03S	22	46	88.6	44.3	44.3	21.5	4	14	76	3.1	0.15	0.66	0.67	0.6	0.21	72	19	19	VHK-B2A	49	17	1	30	25	21.5	31		
1/2	1/2	VHK□AR-04S-04S	22	46	97.4	48.7	48.7	21.5	4	14	81	3.4	0.15	0.71	0.67	0.6	0.21	101	22	22	VHK-B2A	49	17	1	30	25	21.5	31		

# VHK-A Series

## Made to Order

Please contact SMC for detailed dimensions, specifications, and lead times.



### 1 IN/OUT Size: Altered 1/4" Valve

X205

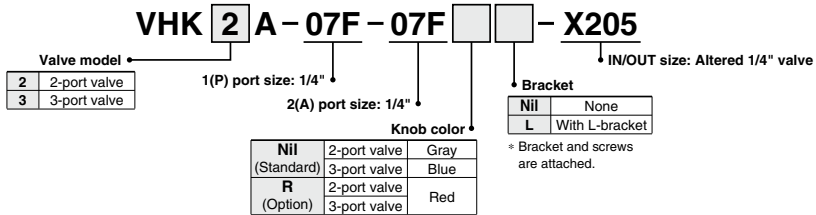

### 2 IN/OUT Size: Altered 5/16" Valve

X216

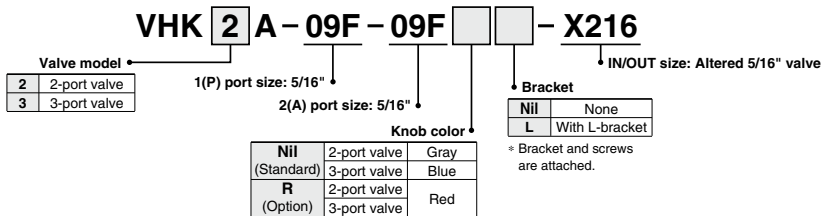

### 3 IN/OUT Size: Altered 3/8" Valve

X209

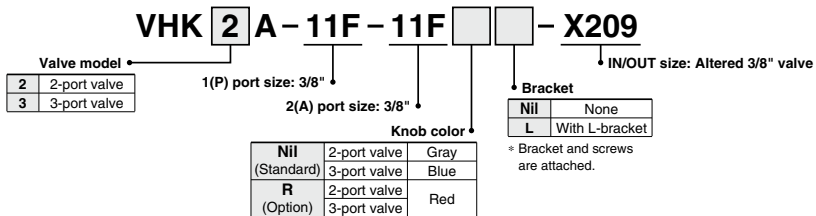

### 4 IN/OUT Size: Altered 1/2" Valve

X247

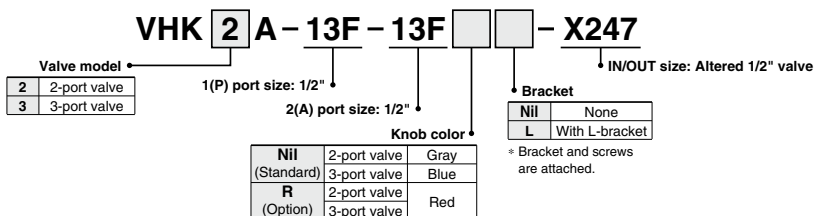



# VHK-A Series/Precautions

Be sure to read this before handling the products.

Refer to page 8 for safety instructions and pages 9 to 15 for 3/4/5 port solenoid valve precautions.

## Design

### ⚠ Warning

1. Please contact SMC when fluids other than air are used.
2. Do not supply air pressure from 2(A) port. The air will leak out from 1(P) port.
3. Since the valve allows a small volume of air leakage, it may not be suitable for holding pressure in a pressure vessel.

## Selection

### ⚠ Caution

#### Operation method:

The valve must be switched to OPEN or SHUT instantly and securely. Stopping the handle halfway between the extreme positions may cause malfunction.

## Mounting

### ⚠ Caution

#### L type bracket mounting:

Apply a tightening torque of 0.5 to 0.6 N·m to the bolts when the bracket is mounted on the body.

## Piping

### ⚠ Caution

#### Precautions for handling the male threads of the R pipe fitting with seal

1. Use a wrench to secure the hexagon portion to screw in the fitting. If the size of the wrench is not appropriate it will be stripped.
2. To screw in the fitting, first hand-tighten; then, use a tool to rotate it 2 to 3 turns. If it is tightened excessively, more sealing agent will be forced out. Therefore, make sure to remove the extra sealing agent.
3. Re-use of fittings:
  - 1) Ordinarily, the fitting can be reused 2 to 3 times.
  - 2) Before reusing the fitting, clear off the sealing agent that remains on the removed pipe fitting using an air blower. If the sealing agent is peeled off and enters the peripheral equipment, it can cause air leakage.
  - 3) If the sealing effect has been lost, wrap a seal tape over the sealing agent to reuse the fitting. Do not use any sealing agent other than seal tape.

## One-touch Fitting

### ⚠ Caution

1. When tubing of brands other than SMC's are used, verify that the tubing O.D. satisfies the following accuracy;

- Nylon tubing ..... Within  $\pm 0.1$  mm
- Soft nylon tubing ..... Within  $\pm 0.1$  mm
- Polyurethane tubing ..... Within  $+0.1$  mm,  $-0.2$  mm

If the tube's external accuracy is not satisfied, it may not be possible to connect the tube. Even if it is connected, air leakage or tube disconnection may result.