

Manifold Regulator

ARM1000/2000 Series

4 connection methods

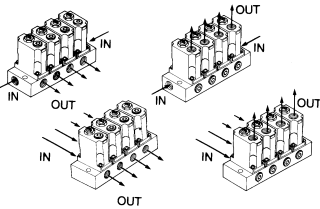

Small size pressure gauge Ø15

Backflow function available on the standard model

Space-saving

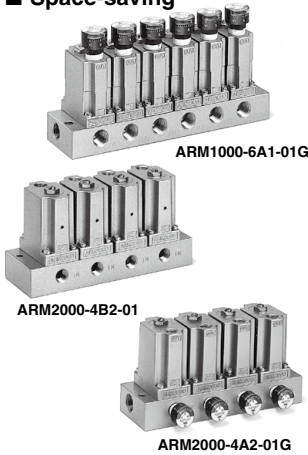

Symbol

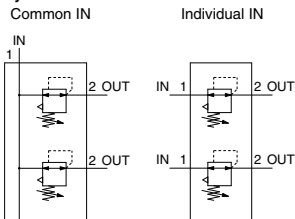

Note) A standard model is equipped with a backflow function. A main valve opens when the inlet pressure is released, and then an outlet pressure backflows into the inlet side.

Standard Specifications

Fluid	Air
Proof pressure	1.2 MPa
Maximum operating pressure	0.8 MPa
Regulating pressure range	Standard: 0.05 to 0.7 MPa
	0.2 MPa setting 0.05 to 0.2 MPa
Ambient and fluid temperature	-5 to 60°C (No freezing)
Fluid	Air
Cracking pressure (Valve)	0.02 MPa
Construction	Relieving type

Port Size/Weight

Model	Piping	Port size		Weight (g)	
		IN side	OUT side	Total weight (n: stations)	Regulator (Except manifold)
ARM1000	Common IN	1/8	1/8	(80 x n) + 23	57
	Individual IN	1/8	1/8	(79 x n) + 25	
ARM2000	Common IN	1/4	1/8	(188 x n) + 43	136
	Individual IN	1/8	1/8	(187 x n) + 45	

How to Order

ARM 1000 - 5 A1 - 01 G -

- Regulator for manifold**: ARM 1000
- Number of stations**: 5
- Body size**: A1 (1 station, 1000; 10 stations, 2000)
- Piping**: A1 (Common, manifold side; A2 (Common, body side; B1 (Individual, manifold side; B2 (Individual, body side)
- Port size (OUT side)**: 01 (1/8)
- Thread type**: G (None; N (NPT)
- Accessory**: Nil (None; G (With pressure gauge)

Semi-standard

Nil	0.7 MPa setting (Standard)
1	0.2 MPa setting

Note 1) Pressure gauge for 1.0 MPa is used.
Note 2) Compared with standard specifications, its adjusting spring has only been changed. It is not the product which does not allow the pressure more than 0.2 MPa. Adjusting spring is not replaceable.

Symbol	IN	OUT
A1	Common	Manifold side
A2		Body side
B1	Individual	Manifold side
B2		Body side

Note 1) In the case of A1 and B1, a pressure gauge or a plug is mounted on the body side, while in case of A2 and B2, on the manifold side.

Note 2) When mounting a pressure gauge on the body side, its front faces the adjusting screw.

Option / Pressure Gauge: G15-10-01

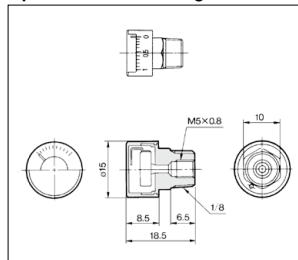

● Precautions—When drain or oil, etc. gets into the gauge, an error may occur for pressure indication.

How to Order

G15-10-01

- Max. display pressure**: 10 (1.0 MPa)
- Connecting thread**: 01 (1/8 male thread, M5 female thread)
- Thread type**: Nil (None; N (NPT)

Note) Use caution not to tighten excessively when mounting a pressure gauge, otherwise it may result in a breakdown. For sealing, use a sealant tape.

ARM1000/2000 Series

Construction (Individual IN)

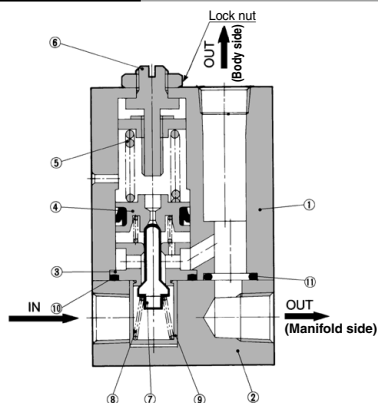

Component Parts

No.	Description	Material	Note
1	Body	Aluminum die-casted	Chromate treated
2	Manifold	Aluminum alloy	Chromate treated
3	Valve guide	Brass	
4	Piston	Brass	
5	Adjusting spring	Steel wire	Zinc chromated
6	Adjusting screw	Steel	Electroless nickel plated

Replacement Parts

No.	Description	Material	Part no.	
			ARM1000	ARM2000
7	Valve	Brass, HNBR	134819-30#1	13626-30#1
8	Valve spring	Stainless steel	13615	13625
9	Valve guide	Polyacetal	13614	13624
10	O-ring	NBR	KA01020	KA00361
			16.5 x 13.5 x 1.5	23 x 20 x 1.5
11	O-ring	NBR	KA00476	KA00087
			JIS B 2401 P7	JIS B 2401 P8

Setting

1. Make sure to check the inlet pressure before setting the outlet pressure. Turning the pressure adjustment knob clockwise increases the outlet pressure and turning it counterclockwise decreases the pressure. (To set the pressure, do so in the direction of pressure increase.)
2. Set the outlet pressure to 85% or less of the inlet pressure.

⚠️ Precautions

Be sure to read this before handling the products. Refer to page 9 for safety instructions and pages 13 to 17 for precautions on every series.

Mounting/Adjustment

⚠️ Warning

1. In the case of the common IN type, supply pressure from the two IN ports from both ends. Failure to observe this procedure could result in an excessive pressure drop.

⚠️ Caution

1. Release the lock to adjust the pressure. After the adjustment, engage the lock. Failure to observe this procedure could damage the knob or cause the outlet pressure to fluctuate.
-<Lock operating method->
Loosen the lock nut to unlock it, and tighten it to lock it.
2. This product can be used as a regulator with a check valve by installing it between solenoid valve and actuator.

Maintenance

⚠️ Warning

1. Make sure to perform a periodic inspection of the pressure gauge when it is used by installing it between a solenoid valve and an actuator, etc. Sudden pressure changes could happen and the durability of the product could be reduced. Using an electronic type pressure gauge is recommended, depending on the situation.

Selection

⚠️ Caution

1. When operating at an inlet pressure lower than the inlet pressure used in the flow rate characteristics graph, the pressure drop on the outlet side may be greater. Therefore, be sure to conduct testing using the actual equipment. For pressure control equipment selection, refer to the "Product Selection Guide."

Flow Rate Characteristics (Representative value)

ARM1000

Inlet pressure: 0.7 MPa

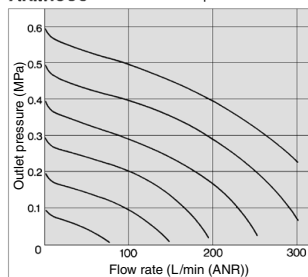

ARM2000

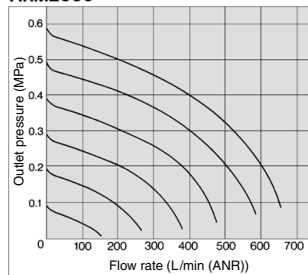

Pressure Characteristics (Representative value)

(Initial setting) Inlet pressure: 0.7 MPa

Outlet pressure: 0.2 MPa

Flow rate: 10 L/min (ANR)

ARM1000

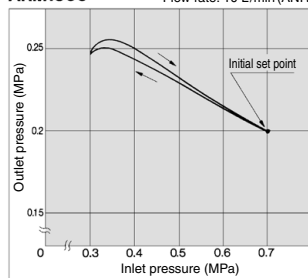

ARM2000

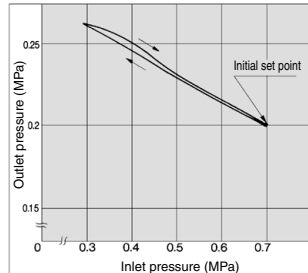

Dimensions

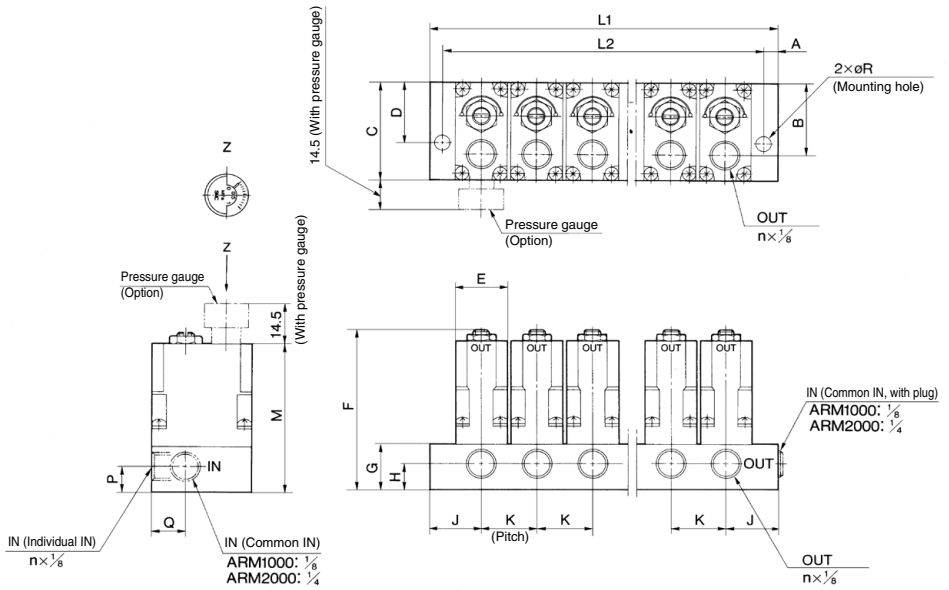

Dimensions

Model	Symbol	A	B	C	D	E	F	G	H	J	K	M	P	Q	R
ARM1000		4.5	25	34	21	18	56	16	9	18	19	52	9	11.5	4.8
ARM2000		4.5	34.5	43	28	27	70	20	11.5	24	28	66	11.5	16.5	4.8

Dimensions by the Number of Stations

Model	Symbol	Manifold stations (n)									
		1	2	3	4	5	6	7	8	9	10
ARM1000	L1	36	55	74	93	112	131	150	169	188	207
	L2	27	46	65	84	103	122	141	160	179	198
ARM2000	L1	48	76	104	132	160	188	216	244	272	300
	L2	39	67	95	123	151	179	207	235	263	291