

E-P HYREG[®]

VY1 Series

This hybrid regulator combines a regulator and a solenoid valve.

Stepless control through electric signals

Port sizes M5 to 2 inches can be covered by combining an ultra-compact electro-pneumatic pilot valve and a 3 port high-capacity exhaust main regulator.

Simple circuit configuration

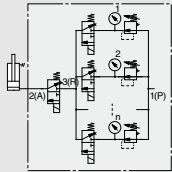

Simplified main circuit

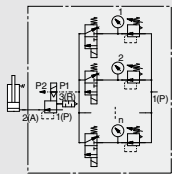

Simplified pilot circuit

Piping labor reduced
A flexible system has been adopted.

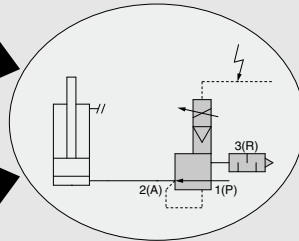

E-P HYREG[®]



VY1D00

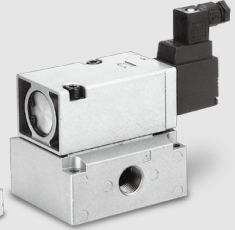

VY1400

Application example

Capable of performing multistage pressure control and stepless pressure control by varying the electrical signals.

Cylinder Thrust Control

Tension control balancer

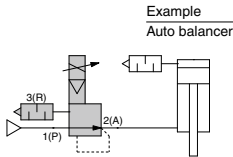

Drive and Thrust Control

Cylinder behavior and pressurization control for peening and stamping

Example

Welding pressure control of spot welding gun cylinder
Loading cylinder control

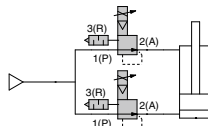

Flow Control of Various Fluids

For remote control of another air operated valve

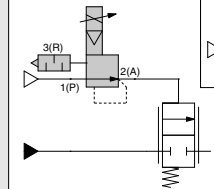

Pressure Control of Tank

Automatic adjustments

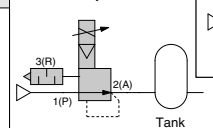

Air Flow Control of Nozzle ^(Note)

Air blowing
Air cooling

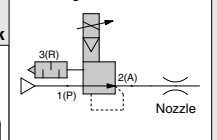

^(Note) Use for the sonic flow.

Ease of handling

Having the amplifier built into the electro-pneumatic pilot valve, only an external power supply and signal (voltage, current) need to be connected.

Manifold capable

Using the VVEXB/2/4 series, a maximum 10 station manifold is possible.

ARJ

AR425
to 935

ARX

AMR

ARM

ARP

IR□-A

IR

IRV

VEX

SRH

SRP

SRF

ITV

IC

ITVH

ITVX

PVQ

VY1

VBA

VBAT

AP100

E-P HYREG® VY1 Series

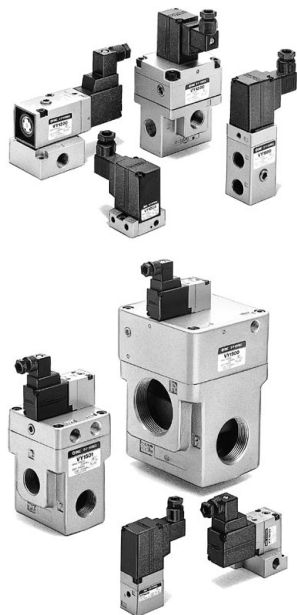

Symbol

Internal pilot

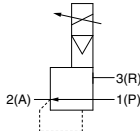

External pilot

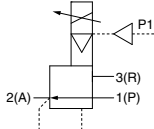

How to Order

E-P HYREG
Maximum operating pressure: 0.9 MPa

Made to Order
X39 Low wattage specification P.1003

Pilot type
0 Internal pilot
1 External pilot (Note 1)
Note 1) Except body size D

Power source/Command signal

Symbol	Power source voltage DC	Command signal DC	Input impedance
Nil		1 to 5 V	67 kΩ
1	24 V	0 to 10V	10 kΩ
2		4 to 20 mA	120 Ω
3		0 to 20 mA	
5	12 V	1 to 5 V	67 kΩ
6		0 to 10 V	10 kΩ
7		4 to 20 mA	120 Ω
8	0 to 20 mA		

Thread type

Nil	Rc
F	G ⁽²⁾
N	NPT
T	NPTF

Note 2) Not conforming to ISO1179-1.

Ordering Code: VY1 1 0 0 - 01 - - -

Body size

Port size Rc⁽⁷⁾

Option

Mounting	Symbol	Symbol	Port 1(P), 2(A)	Port 3(R)	B (Bracket)	F (Foot)	G (Pressure gauge)	N (Silencer)	Applicable pilot valve ⁽⁴⁾		
Base mounted	D	00	Without sub-plate	—	—	—	—	—	VY1D00- □00 ⁽⁵⁾		
		M5	M5	—	—	—	—	●			
	B	00	Without sub-plate	—	—	—	—	—			
		M5	M5	—	—	—	—	●			
	2	01	Without sub-plate	—	—	—	—	●		●	
		02	1/8	—	—	—	—	●		●	
		03	1/4	—	—	—	—	●		●	
		04	3/8	—	—	—	—	●		●	
	Body ported	A	M5	M5	● ⁽³⁾	● ⁽³⁾	—	—		—	VY1B00- □00 ⁽⁵⁾
			01	1/8	● ⁽³⁾	● ⁽³⁾	●	●			
1		02	1/4	—	—	—	—	—			
		03	3/8	—	—	—	—	—			
3		02	1/4	—	—	—	—	—			
		03	3/8	—	—	—	—	—			
5		04	1/2	—	—	—	—	—			
		06	3/4	—	—	—	—	—			
7		10	1	—	—	—	—	—	—		
		12	1 1/4	—	—	—	—	—	—		
	14	1 1/2	—	—	—	—	—	—			
	20	2	—	—	—	—	—	—			
	9	10	1	1 1/4	●	—	●	●			
		14	1 1/2	2	●	—	●	●			

Note 3) Only bracket or foot may be mounted.

Note 4) When replacing the pilot valve, it may not satisfy characteristics such as accuracy, etc. Confirm the product works under the operating conditions before using. If SMC is requested to repair the product, SMC confirms whether characteristics are satisfied.

Note 5) □ in the applicable pilot valve part number is designated for the power source/command signal.

Note 6) Cut off the command signal when the pressure control on the outlet side is not required, such as when the line is temporarily halted, etc. Refer to Specific Product Precautions on page 1006.

Note 7) Face seal type One-touch fittings cannot be used.

Standard Specifications

Model		VY1D00	VY1A0 ⁰	VY1B0 ⁰	VY110 ⁰	VY120 ⁰	VY130 ⁰	VY140 ⁰	VY150 ⁰	VY170 ⁰	VY190 ⁰											
Port size	Port	M5	M5	M5	01	01	02	01	02	02	03	04	02	03	04	04	06	10	10	12	14	20
	1(P)	M5	M5	M5	1/8	1/8	1/4	1/8	1/4	1/4	3/8	1/2	1/4	3/8	1/2	1/2	3/4	1	1	1 1/4	1 1/2	2
	2(A)																					
	3(R)																					
Weight (Kg) ⁽¹⁾	0.11	0.16	0.19	0.25			0.35			0.55			0.75			1.5		2		4		
Hysteresis ⁽²⁾	0.009 MPa		0.023 MPa						0.027 MPa			0.045 MPa										
Sensitivity ⁽²⁾	0.005 MPa		0.009 MPa						0.014 MPa			0.018 MPa										
Repeatability ⁽²⁾	± 0.005 MPa		± 0.009 MPa						± 0.009 MPa			± 0.018 MPa										
Response time ⁽²⁾	10 ms		30 ms																			
Fluid	Air																					
Ambient and fluid temperature	0 to 50°C (No condensation)																					
Maximum operating pressure	0.9 MPa																					
Regulating pressure range	0.05 to 0.84 MPa (Supply pressure 0.9 MPa)																					
External pilot pressure	— (Direct operated)		Set pressure + 0.04 to 0.9 MPa (VY1□01)																			
Command signal ⁽³⁾	1 to 5 VDC, 0 to 10 VDC, 4 to 20 mA DC, 0 to 20 mA DC																					
Power supply	12 VDC±10%, 24 VDC ±10%, 1.8 W or less																					
Electrical entry	DIN terminal																					
Applicable cable	Cable O.D. ø4 to 6.5																					
Bleed air flow (Pilot EXH port)	When not operating: Zero, When operating: 10 L/min (ANR) (Supply pressure 0.9 MPa)																					
Installation	Universal																					
Lubrication	Not required ⁽⁴⁾																					

- Note 1) The mass of the base mounting type (D/B/2/4 size) with sub-plate is indicated.
- Note 2) All property values indicate maximum values.
- Note 3) Cut off the command signal when the pressure control on the outlet side is not required, such as when the line is temporarily halted, etc. Refer to Specific Product Precautions on page 1006.
- Note 4) To lubricate the outlet side of "VY", use "VY" as an external pilot. Avoid lubrication to the pilot air.
- Note 5) The non-lubricated specification is not applicable to these models.
- Note 6) The service life is approximately 4000 to 5000 operating hours. (When using AF + AFM)
This may be approximately 3000 hours with ultra-dry air (dew point -40°C or equivalent).

Option

Description		Part no.									
		VY1D00	VY1A0 ⁰	VY1B0 ⁰	VY110 ⁰	VY120 ⁰	VY130 ⁰	VY140 ⁰	VY150 ⁰	VY170 ⁰	VY190 ⁰
Bracket	B	—	VEXA-18-2A	—	VEX1-18-1A	—	VEX3-32A	—	VEX5-32A	VEX7-32A	VEX9-32A
(With bolt, washer)	F	—	VEXA-18-3A	—	VEX1-18-2A	—	—	—	—	—	—
Pressure gauge	G	—	—	G27-10-R1-X207	G27-10-01		G36-10-01			G46-10-01	
Pilot EXH port silencer	N	AN120-M5	—	—	AN120-M5		AN101-01	AN120-M5		AN210-02	

Sub-plate and Base Gasket Part No.

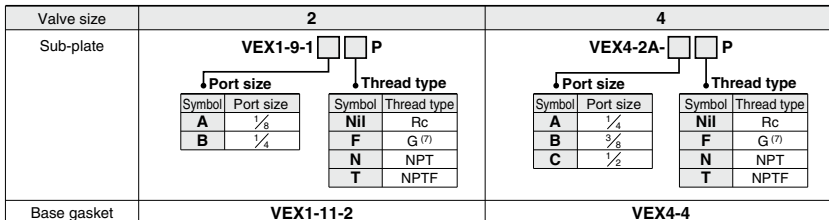
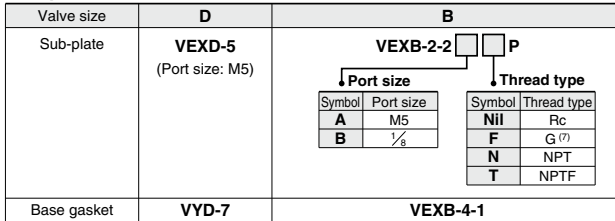

Note 7) Not conforming to ISO1179-1.

ARJ
AR425 to 935
ARX
AMR
ARM
ARP
IR□-A
IR
IRV
VEX
SRH
SRP
SRF
ITV
IC
ITVH
ITVX
PVQ
VY1
VBA
VBAT
AP100

Characteristics

Command Signal — Outlet Pressure Characteristics (Characteristics of pressure setting)

Port 1(P) Pressure 0.9 MPa (-X39: 0.7 MPa)

VY1D00

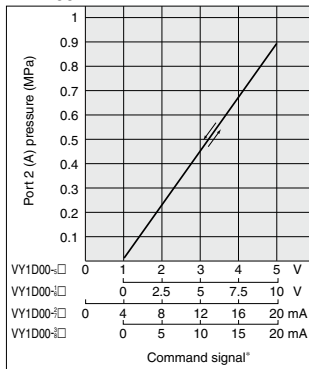

VY1A00/1A01, VY1B00/1B01

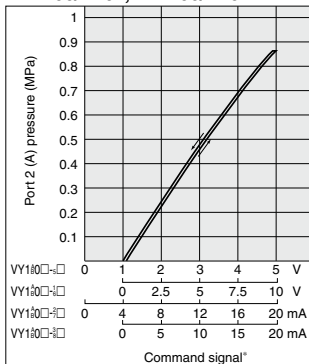

VY1100/1101, VY1200/1201

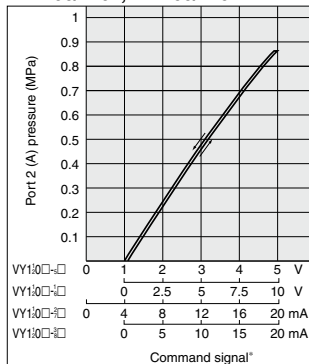

VY1300/1301

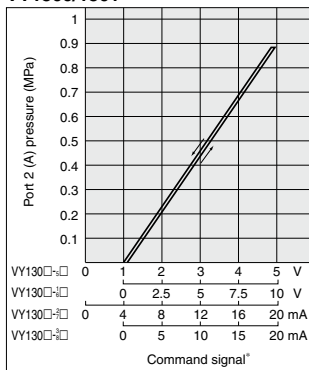

VY1400/1401

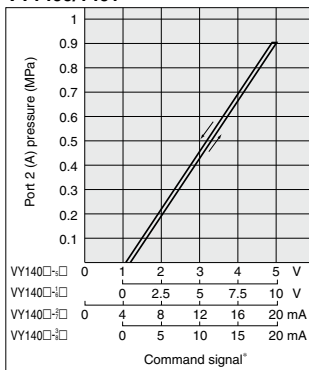

VY1500/1501

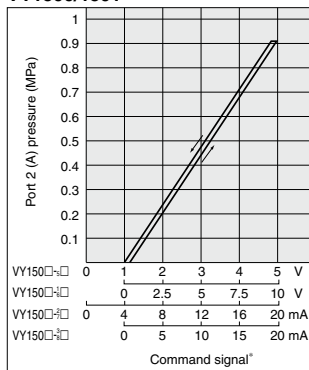

VY1700/1701

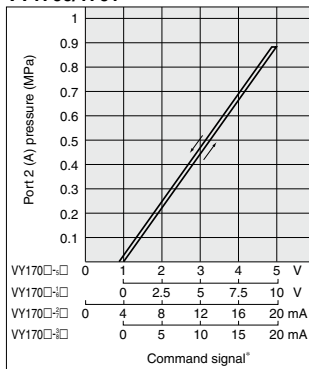

VY1900/1901

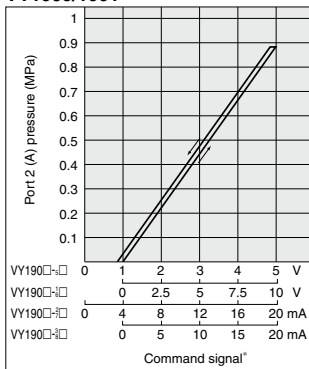

Command signal voltage (current) for starting the operation of a pilot valve VY1D00 (-X39) (direct operated)
(There is dispersion in the following range)

Symbol ⁽¹⁾	Input signal	Operation start range
Nil, 5	1 to 5 VDC	0.93 to 1.07 VDC
1, 6	0 to 10 VDC	0.01 to 0.1 VDC
2, 7	4 to 20 mA DC	3.7 to 4.3 mA DC
3, 8	0 to 20 mA DC	0.02 to 0.2 mA DC

Note 1) Enter symbols above □ in VY1D00-□**, □ indicates power supply and a command signal.
 Note 2) Other body sizes add the dispersion on the above data when the main valve activates.

* For the command signal range of the low wattage specification (X39), refer to the specifications on page 1003.

Pressure Characteristics

VY1D00

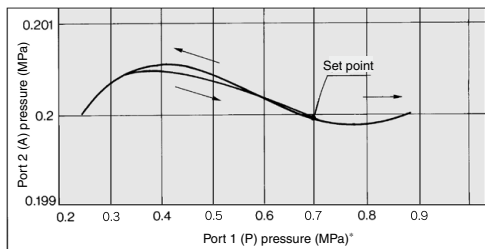

VY1A0⁰/1B0⁰

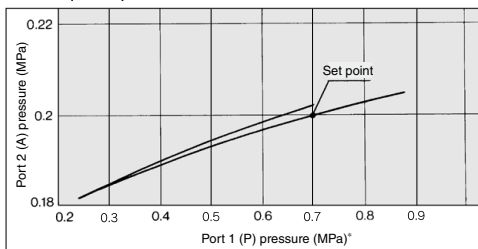

VY110⁰/120⁰

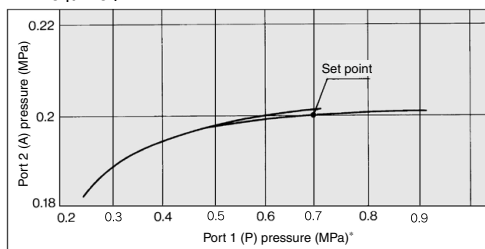

VY130⁰

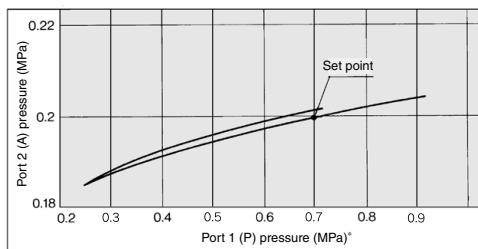

VY140⁰

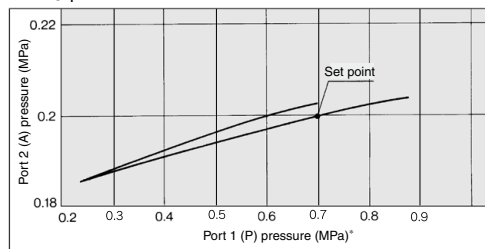

VY150⁰

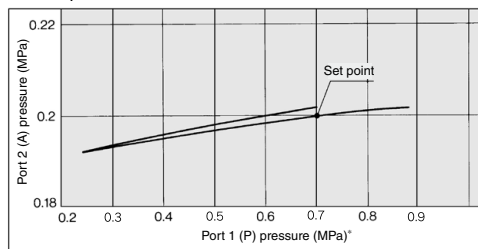

VY170⁰

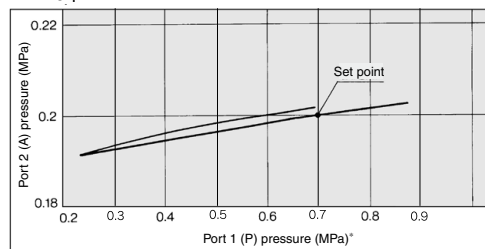

VY190⁰

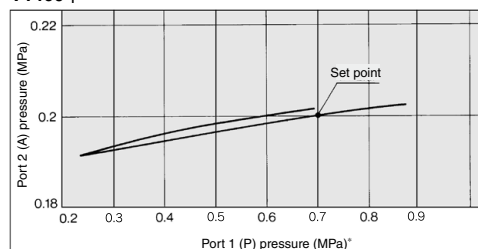

* For the low wattage specification (X39), the maximum pressure of port 1 (P) is 0.7 MPa.

ARJ

AR425 to 935

ARX

AMR

ARM

ARP

IR□-A

IR

IRV

VEX

SRH

SRP

SRF

ITV

IC

ITVH

ITVX

PVQ

VY1

VBA

VBAT

AP100

VY1 Series

Characteristics

Flow Rate Characteristics

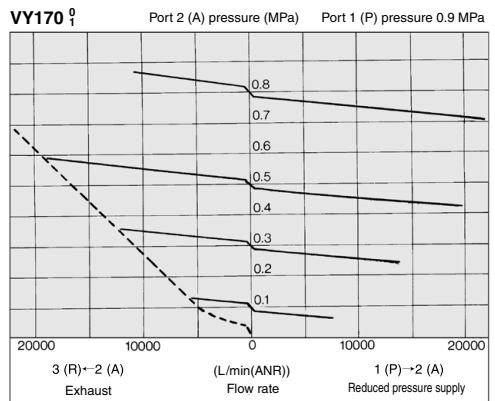
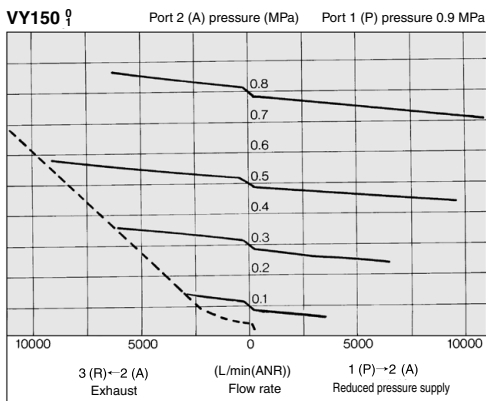
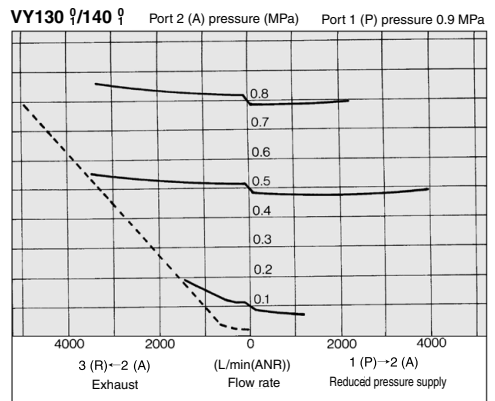
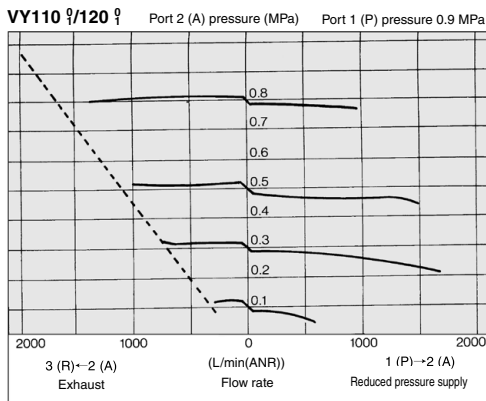
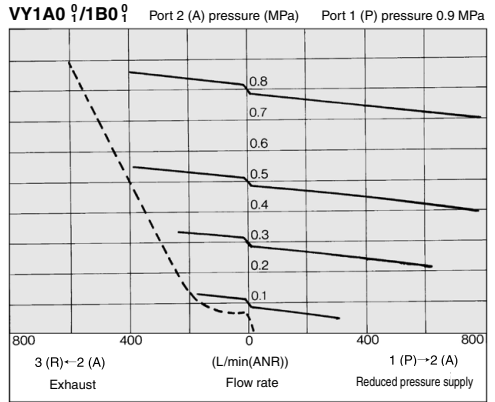
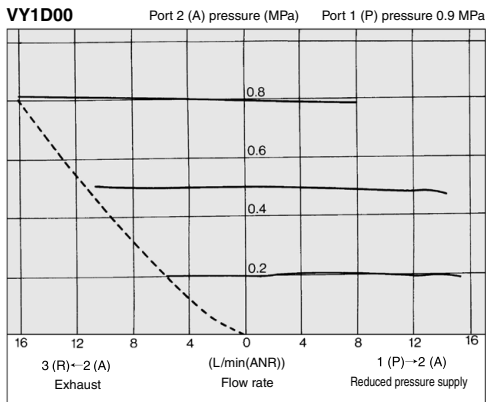

VY190 Port 2 (A) pressure (MPa) Port 1 (P) pressure 0.9 MPa

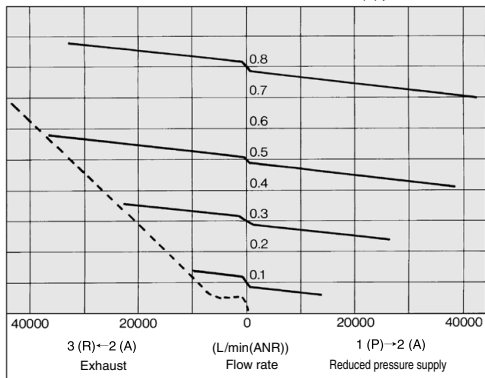

2. Exhaust Time from 10 L Tank

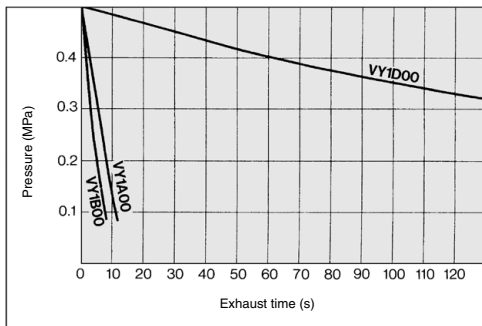

Exhaust Time from 1000 L Tank

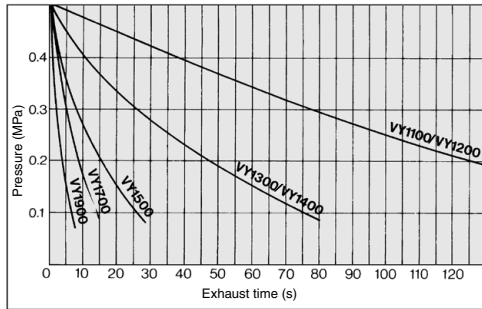

3. Exhaust time from optional pressure point

Ex.) Using VY1500, lower the 500 L tank pressure from 0.4 to 0.1.

a) If describing the above graph in accordance with graphs, the exhaust time is read; 27 - 3 = 24 s.

b) Then, to convert the time into one from a 500 L tank.

$$t = \frac{\text{Tank capacity}}{1000} \times \left[\text{Read exhaust time} \right]$$

$$= \frac{500}{1000} \times 24$$

$$= 12$$

Then, the result is 12 s.

Exhaust Time

1. Exhaust Time from 0.5 MPa to 0.1 MPa

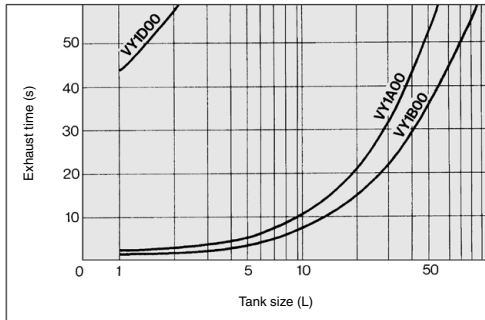

Exhaust Time from 0.5 MPa to 0.1 MPa

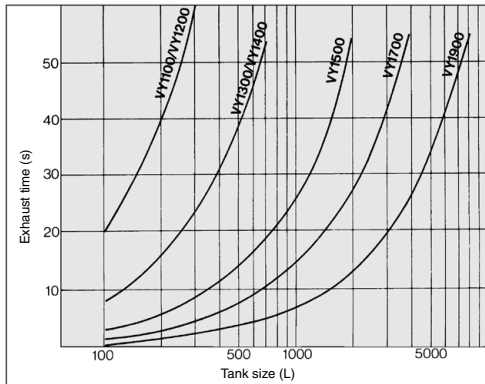

ARJ
AR425 to 935
ARX
AMR
ARM
ARP
IR□-A
IR
IRV
VEV
SRH
SRP
SRF
ITV
IC
ITVH
ITVX
PVQ
VY1
VBA
VBAT
AP100

VY1 Series

Dimensions

VY1D00

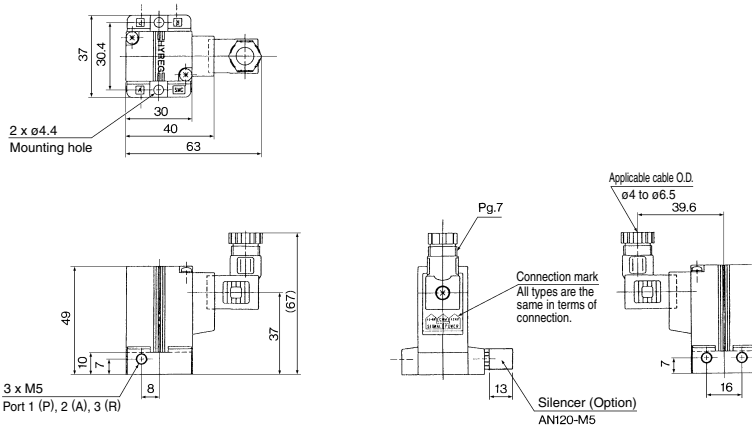

VY1A0₁

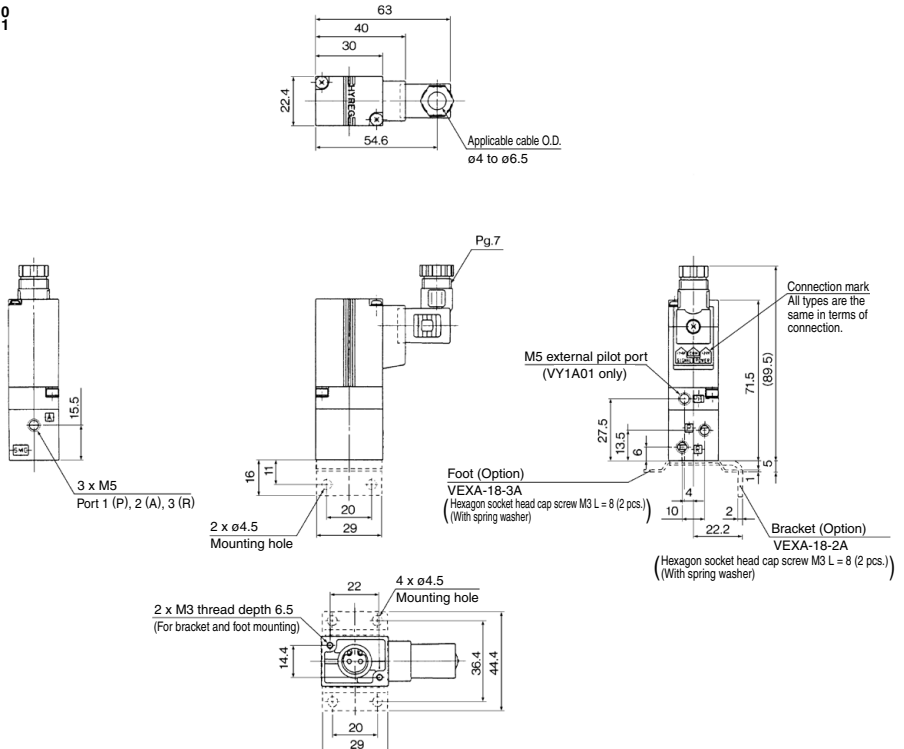

VY1B0⁰

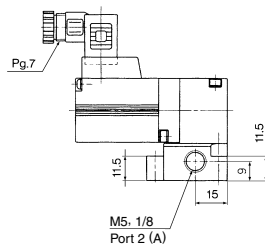
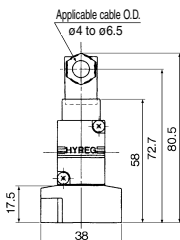
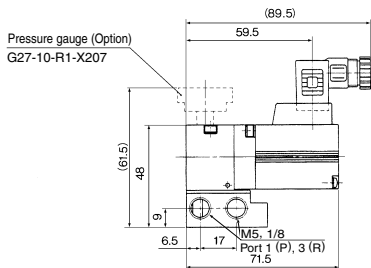
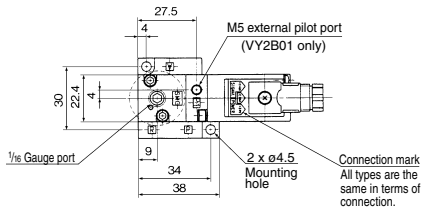

VY110⁰

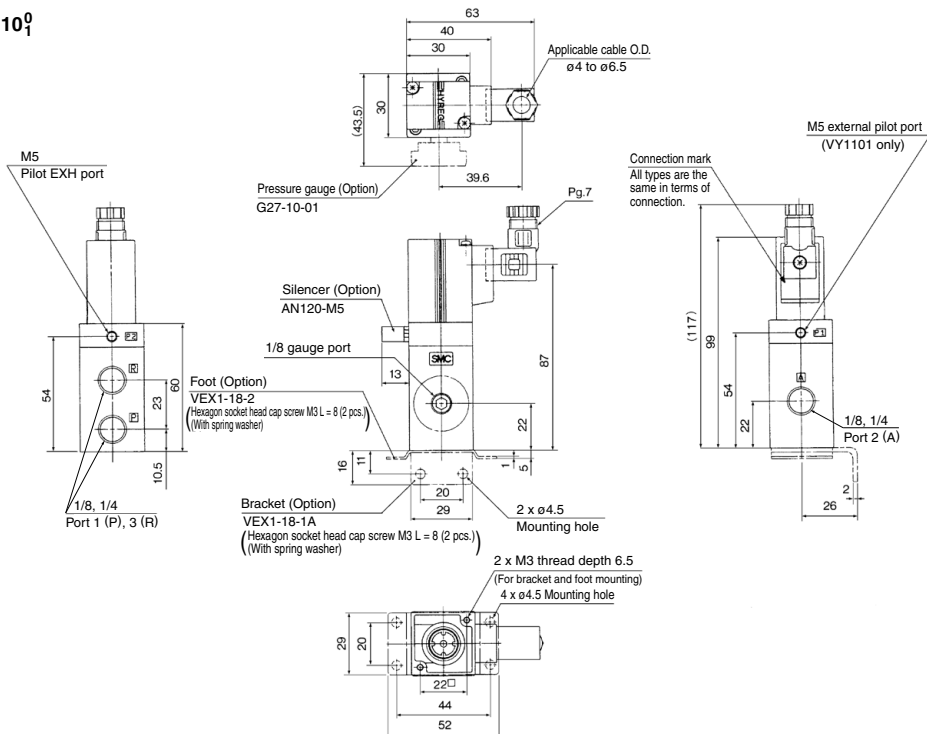

ARJ
AR425 to 935
ARX
AMR
ARM
ARP
IR□-A
IR
IRV
VEX
SRH
SRP
SRF
ITV
IC
ITVH
ITVX
PVQ
VY1
VBA
VBAT
AP100

VY1 Series

Dimensions

VY120⁰

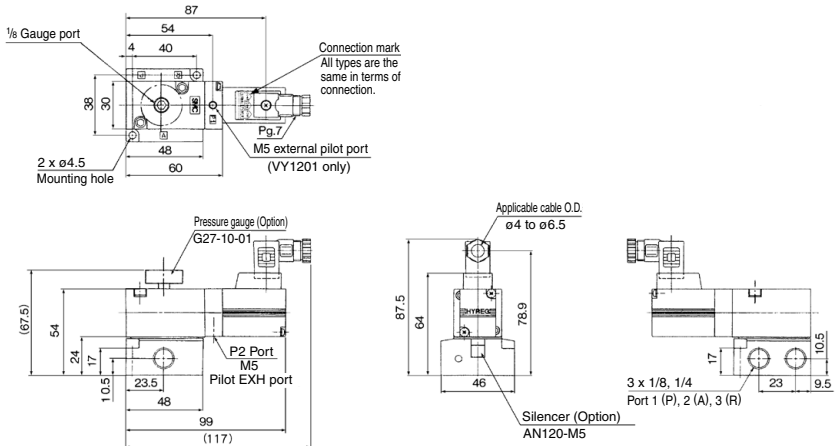

VY130⁰

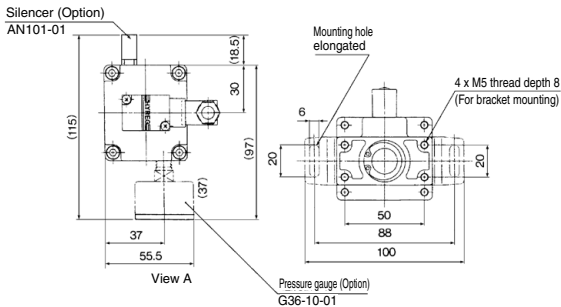
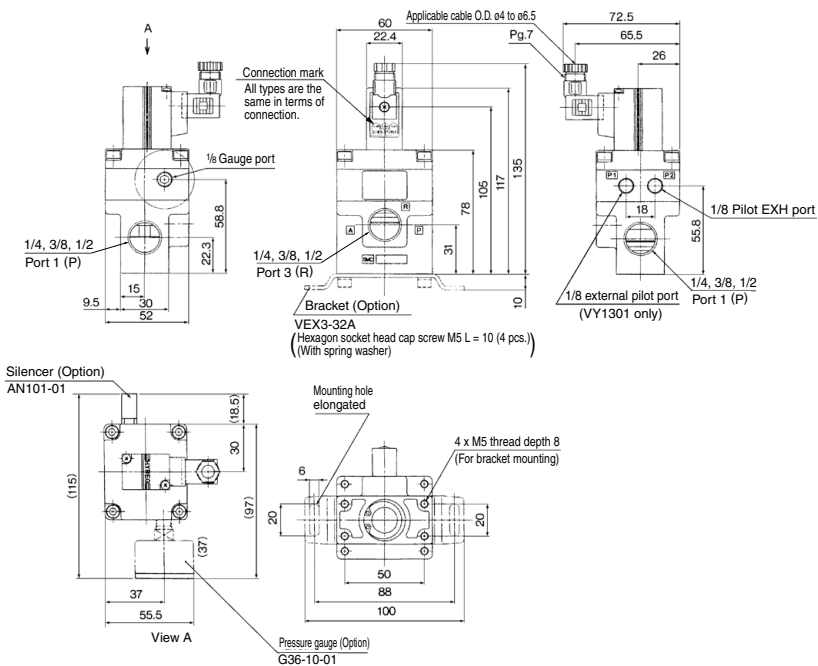

VY140₁

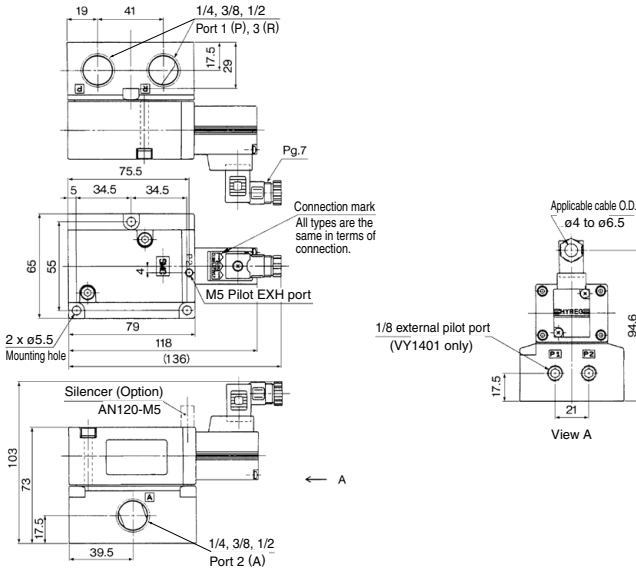

VY150₁

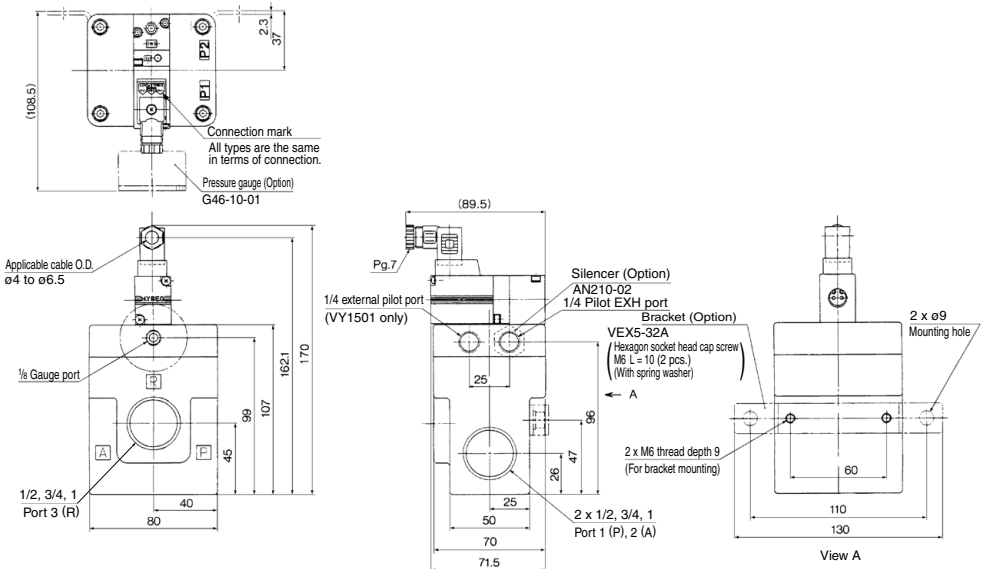

ARJ

AR425
to 935

ARX

AMR

ARM

ARP

IR □-A

IR

IRV

VEX

SRH

SRP

SRF

ITV

IC

ITVH

ITVX

PVQ

VY1

VBA

VBAT

AP100

VY1 Series

Dimensions

VY170₁

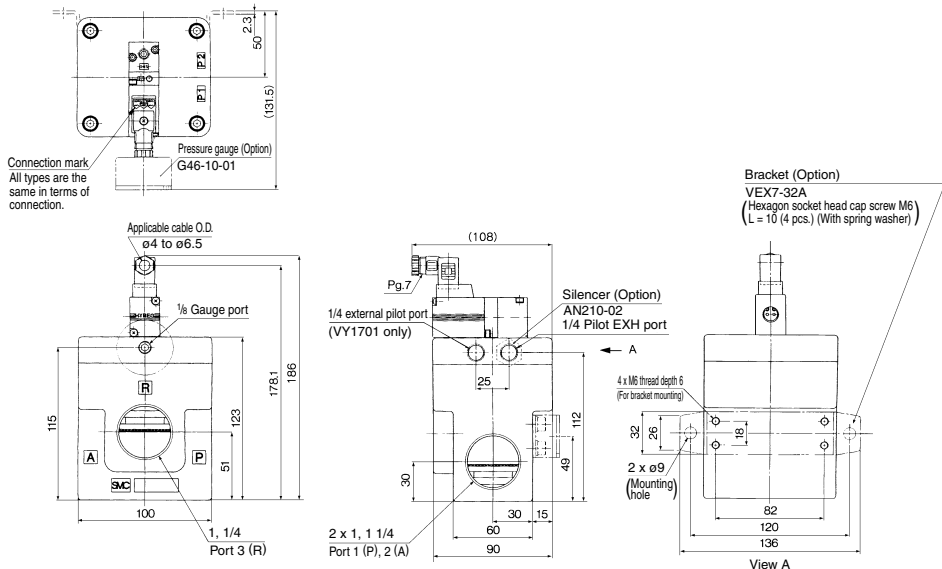

VY190₁

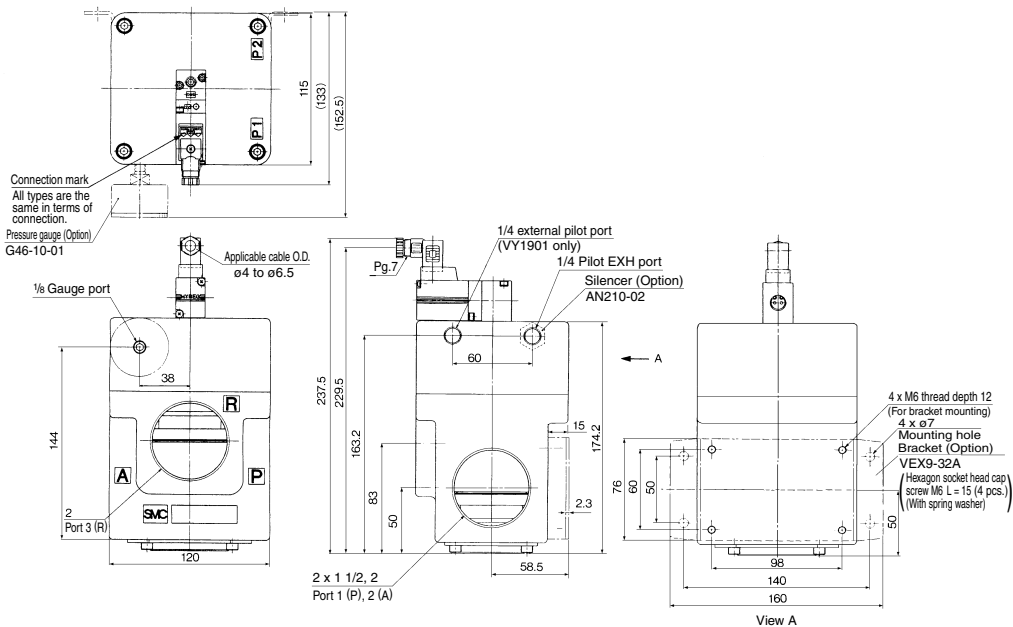

Construction/Component Parts/Working Principle

VY1D00

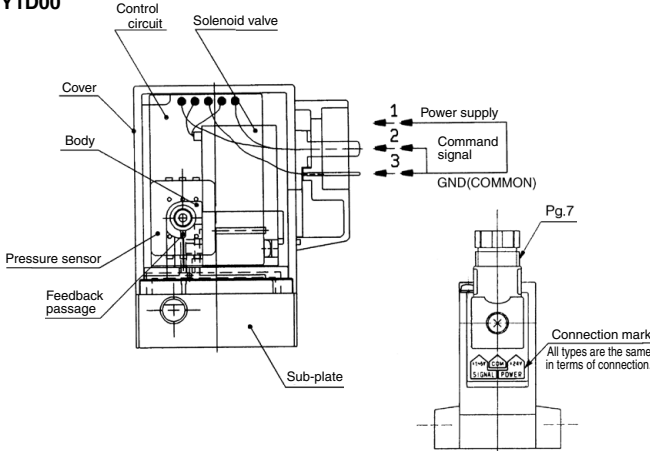

The VY1D00, which is the smallest direct drive, consists of a solenoid, pressure sensor, control circuit, body cover, and a sub-plate. The type with sub-plate can be used alone, and the type without sub-plate can also be used as a pilot valve.

Working principle

- When the command signal is below 1 VDC, (refer to page 992) the solenoid valve is inactive, and the port 2(A) pressure is zero.
 - When a command signal between 1 and 5 VDC is provided, the solenoid is activated.
 - The port 2(A) pressure is fed back to the control circuit by the pressure sensor.
 - The control circuit compares the feedback signal with the size of the command signal that was provided, and:
 - 1) If the feedback signal is smaller, current is supplied to the solenoid valve to raise the port 2(A) pressure [from 1(P) to 2(A)].
 - 2) If the feedback signal is greater, current is not supplied to valve to reduce the port 2(A) pressure [from 2(A) to 3(R)].
- The above processes 1) and 2) are repeated at high speeds to set the port 2(A) pressure.

Circuit

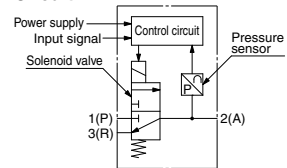

VY1A0⁰, VY1B0⁰ (Pilot valve: VY1D00-□00)

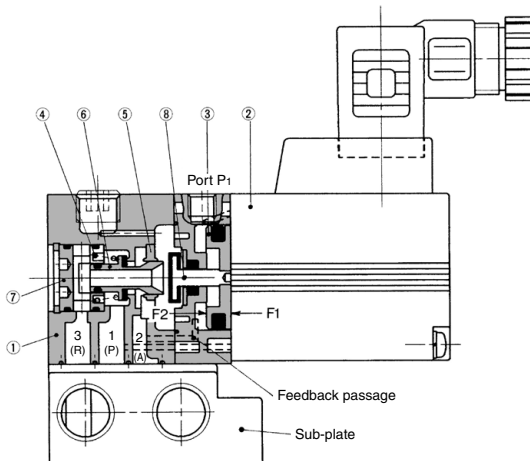

Working principle

- The supply [1(P) to 2(A)] valve of valve ① and the exhaust [2(A) to 3(R)] valve close due to the balance between actuating forces F1 and F2. Actuating force F1 is applied to the right surface of pressure regulation piston ③ by the pilot pressure (pilot valve assembly ②: VY1D00-□00), and actuating force F2 is applied to the left surface of the pressure regulation piston by the port and pressure that passes through the feedback passage. Thus, the port 2(A) pressure that corresponds to the pilot pressure is established.
- When the port 2(A) pressure becomes higher than the pilot pressure, F2 becomes greater than F1. This causes only the pressure regulation piston to move to the right, and the exhaust valve seat to open, allowing the air to be discharged from port 2(A) to port 3(R). When the port 2(A) pressure drops to reach a balance, the regulator returns to the set state.
- Conversely, if the port 2(A) pressure is lower than the pilot pressure, F2 becomes lower than F1. This causes the pressure regulating piston to move the valve to the left, and the supply valve seat to open, allowing the air to be supplied from port 1(P) to port 2(A). When the port 2(A) pressure balances, the regulator returns to the set state.

Component Parts

	Description	Material
1	Body	Zinc alloy die-casted
2	Pilot valve assembly	—
3	Adjusting piston	Aluminum alloy
4	Spring	Stainless steel
5	Valve guide	Stainless steel
6	Valve	Aluminum alloy/Rubber
7	Retainer	Aluminum alloy
8	Rod	Stainless steel/Rubber

ARJ

AR425
to 935

ARX

AMR

ARM

ARP

IR□-A

IR

IRV

VEV

SRH

SRP

SRF

ITV

IC

ITVH

ITVX

PVQ

VY1

VBA

VBAT

AP100

Construction/Component Parts/Working Principle

VY110⁰, VY120⁰, VY130⁰, VY140⁰ (Pilot valve: VY1D00-□00)
 VY150⁰, VY170⁰, VY190⁰ (Pilot valve: VY1B00-□00)

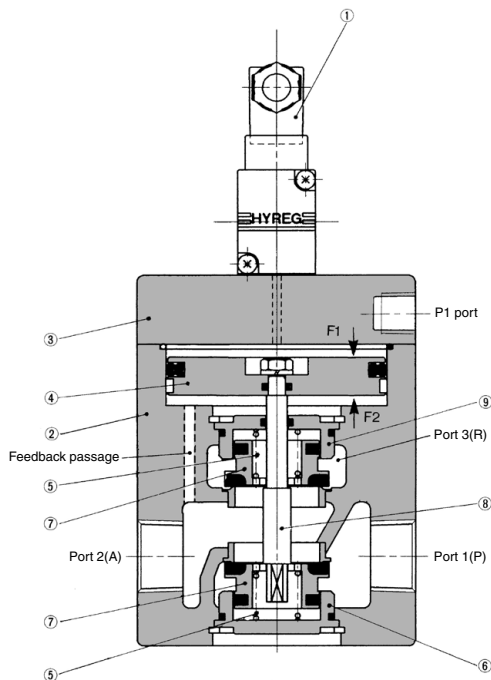

Working principle

- The pair of poppet valves ⑦ close due to the balance between actuating forces F1 and F2. Actuating force F1 is applied to the top surface of pressure regulation piston ④ by the pilot pressure (pilot valve assembly ①: VY1⁰00-□00), and actuating force F2 is applied to the bottom surface of the piston by the port 2(A) pressure that passes through the feedback passage. Thus, the port 2(A) pressure that corresponds to the pilot pressure is established. The poppet valve, which maintains a pressure balance with the port 2(A) pressure, is backed up by spring ⑤ (refer to the diagram on the left).
- When the port 2(A) pressure becomes higher than the pilot pressure, F2 becomes higher than F1. This causes the pressure regulation piston to move upward, and the top poppet valve to open, allowing the air to be discharged from port 2(A) to port 3(R). When the port 2(A) pressure drops to reach a balance, the regulator returns to the state shown in the diagram to the left.
- Conversely, if the port 2(A) pressure is lower than the pilot pressure, F2 becomes less than F1. This causes the pressure regulation piston to move downward, and the lower poppet valve to open, allowing the air to be supplied from port 1(P) to port 2(A). When the port 2(A) pressure rises to reach a balance, the regulator returns to the state shown in the diagram to the left.

Component Parts

No.	Description	Material
1	Pilot valve assembly	—
2	Body	Aluminum alloy
3	Cover	Aluminum alloy
4	Adjusting piston	Aluminum alloy
5	Spring	Stainless steel
6	Valve guide	Aluminum alloy
7	Poppet valve	Aluminum alloy/Rubber
8	Shaft	Stainless steel
9	Valve guide	Aluminum alloy



1 Low Wattage Specification: 0.8 W or less

-X39

Under operating conditions that the ON time, such as charging to the tank is long, the service life may be shortened due to the heat generation of the product. When the operating pressure is 0.7 MPa or less, it is recommended to use the special product “-X39” (Service life: Approx. 7000 operating hours) that is a type of low wattage and suppresses heat generation. Please note that the product characteristics are those with 0.7 MPa or less of the standard specifications.

How to Order

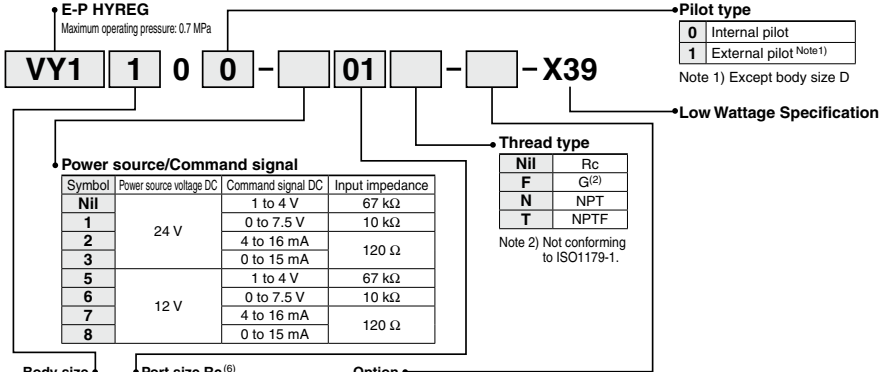

Mounting	Symbol	Body size		Port size Rc ⁽⁶⁾		Option				Applicable pilot valve ⁽⁴⁾
		Symbol	Port 1 (P), 2 (A)	Port 3 (R)	B (Bracket)	F (Foot)	G (Pressure gauge)	N (Silencer)		
Base mounted	D	00	Without sub-plate		—	—	—	—	—	VY1D00- □00-X39 ⁽⁵⁾
		M5	M5		—	—	—	●	—	
	B	00	Without sub-plate		—	—	—	●	—	
		M5	M5		—	—	—	●	—	
	2	01	1/8		—	—	—	●	●	
		02	1/4		—	—	—	●	●	
	4	00	Without sub-plate		—	—	—	—	●	
		02	1/4		—	—	—	—	●	
		03	3/8		—	—	—	—	●	
		04	1/2		—	—	—	—	●	
Body ported	A	M5	M5		● ⁽³⁾	● ⁽³⁾	—	—	—	
		01	1/8		● ⁽³⁾	● ⁽³⁾	●	●	—	
	1	02	1/4		● ⁽³⁾	● ⁽³⁾	●	●	—	
		02	1/4		—	—	●	●	—	
	3	03	3/8		●	—	●	●	—	
		04	1/2		—	—	●	●	—	
	5	04	1/2		—	—	●	●	—	
		06	3/4		●	—	●	●	—	
	7	10	1		—	—	●	●	—	
		12	1 1/4		●	—	●	●	—	
14		1 1/2		—	—	●	●	—		
20		2		●	—	●	●	—		

Note 3) Only bracket or foot may be mounted.

Note 4) When replacing the pilot valve, it may not satisfy characteristics such as accuracy, etc. Confirm the product works under the operating conditions before using. If SMC is requested to repair the product, SMC confirms whether characteristics are satisfied.

Note 5) □ In the applicable pilot valve part number is designated for the power source/command signal.

Note 6) Face seal type One-touch fittings cannot be used.

Specifications (Specifications other than those below are the same as the standard type.)

Max. operating pressure ⁽⁷⁾	0.7 MPa
Regulating pressure range	0.05 to 0.66 MPa (Supply pressure 0.7 MPa)
External pilot pressure	Set pressure +0.04 MPa to 0.7 MPa
Command signal ⁽⁸⁾	1 to 4 VDC, 0 to 7.5 VDC, 4 to 16 mA DC, 0 to 15 mA DC
Power supply	12 VDC ±10%, 24 VDC ±10%, 0.8 W or less
Bleed air flow (Pilot EXH port)	When not operating: Zero, When operating: 7 L/min (ANR) (Supply pressure 0.7 MPa)

Note 7) The supply pressure must be under the maximum operating pressure.

If the supply pressure exceeds the maximum operating pressure, this may cause abnormal leakage from the pilot valve or abnormal set pressure to occur.

Note 8) Cut off the command signal when the pressure control on the outlet side is not required, such as when the line is temporarily halted, etc. Refer to Specific Product Precautions on page 1006.

E-P HYREG® Manifold Specifications

Using the VVEXB/2/4 series, a maximum of 10 stations manifold is possible.

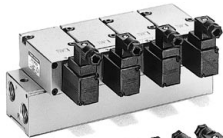

Specifications

Applicable valve	VY1B0 ⁰	VY120 ⁰	VY140 ⁰
Valve stations ⁽¹⁾	2 to 10 stations	2 to 8 stations	2 to 6 stations
Passage	Common supply/exhaust		
Pilot type	Internal pilot, Common external pilot ⁽²⁾		
Pilot port size	M5		
Port size port 1(P), 2(A), 3(R)	1/8	1/4	1/4, 3/8, 1/2
Blanking plate assembly ⁽³⁾	VEXB-6	VEX1-17	VEX4-5

Note 1) VY1B0⁰: 6 stations or more, VY120⁰: 5 stations or more, VY140⁰: 4 stations or more supply pressure to the ports 1(P) on both sides of the manifold and exhaust pressure from the port 3(R) on the both sides.

Note 2) When used as a common external pilot, select the internal pilot specification as an applicable valve.

Note 3) Gasket and mounting bolts are equipped.

How to Order

VVEX **B** - **1** - **5** - **01** □

	Body size	Pilot type	Valve stations	Port size
B For VY1B0 ⁰	1	Internal pilot	22 ^{min} 2 stations	01 1(P), 3(R), 2(A) 1/8
		Common external pilot	21 ^{min} 10 stations	
		2 2 stations		
2 For VY120 ⁰	1	Internal pilot	8 8 stations	02 1/4
		Common external pilot	2 2 stations	
		2 2 stations		
4 For VY140 ⁰	1	Internal pilot	6 6 stations	A 3/8, 1/4 B 3/8 C 1/2, 3/8
		Common external pilot		
		2 2 stations		

Enter the valves and the blank plates to be placed on a manifold in order, starting at the left side of the manifold base (with port 2(A) facing you).

Ex.) VVEX2-2-5-02
 • VY1200-00-G – 4 pcs.
 • VEX1-17 — 1 pc.

Piping thread type

Nil	Rc
F	G (Note 2)
N	NPT
T	NPTF

VY manifold pilot type

Body size B, 2

Pilot type	Manifold base part no.	Applicable valve part no.
Internal pilot manifold	VVEX□-1-□-□□	VY1□00
Common external pilot manifold	VVEX□-2-□-□□	
Individual external pilot manifold	VVEX□-□-□-□□	VY1□01

Note 1) It is recommended to use a common type when the external pilot type is used.

Body size 4

Pilot type	Manifold base part no.	Applicable valve part no.
Internal pilot manifold	VVEX4-1-□-□□	VY1400
Common external pilot manifold	VVEX4-2-□-□□	VY1401

Note 1) In the case of VVEXB, the "2" in the first digit of the valve station number is a dummy part number.

Note 2) Not conforming to ISO 1179-1.

Dimensions

VVEXB

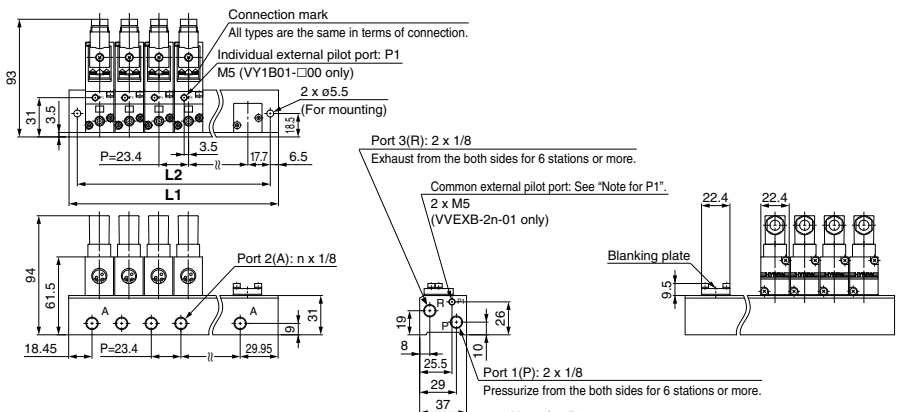

Dimension	Stations	2	3	4	5	6	7	8	9	10
L1		71.8	95.2	118.6	142	165.4	188.8	212.2	235.6	259
L2		58.8	82.2	105.6	129	152.4	175.8	199.2	222.6	246

Note for P1

Confirm internal pilot or common external pilot by checking whether P1 has a M5 screw or not.

Internal pilot:..... P1 has no M5 screw.
 Common external pilot:..... P1 has an M5 screw.

Dimensions

VVEX2

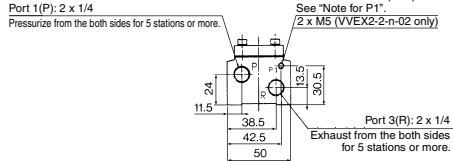
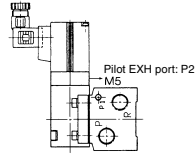
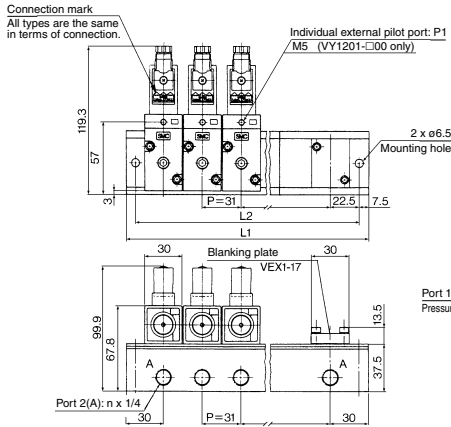

Dimension	Stations	2	3	4	5	6	7	8
L1		91	122	153	184	215	246	277
L2		76	107	138	169	200	231	262

Note for P1

Confirm internal pilot or common external pilot by checking whether P1 has a M5 screw or not.
Internal pilot..... P1 has no M5 screw.
Common external pilot..... P1 has an M5 screw.

VVEX4

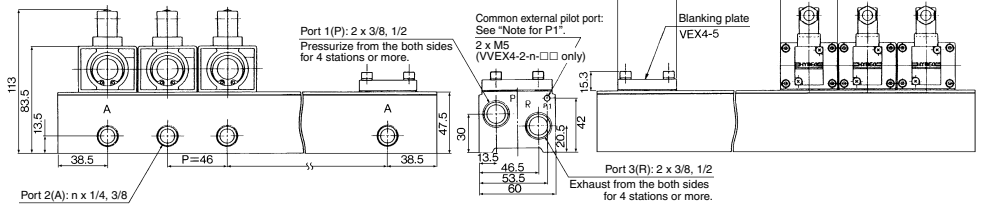
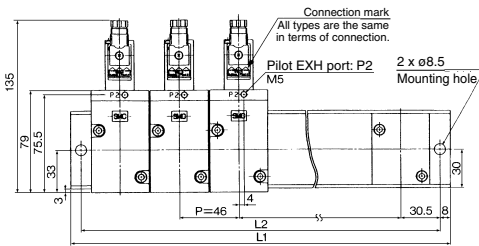

Dimension	Stations	2	3	4	5	6
L1		123	169	215	261	307
L2		107	153	199	245	291

Note for P1

Confirm internal pilot or common external pilot by checking whether P1 has a M5 screw or not.
Internal pilot..... P1 has no M5 screw.
Common external pilot..... P1 has an M5 screw.

ARJ

AR425
to 935

ARX

AMR

ARM

ARP

IR□-A

IR

IRV

VEV

SRH

SRP

SRF

ITV

IC

ITVH

ITVX

PVQ

VY1

VBA
VBAT

AP100



VY1 Series

Specific Product Precautions

Be sure to read this before handling the products. Refer to back page 50 for Safety Instructions and each Best Pneumatics for Precautions on every series.

Piping

⚠ Caution

Tightening the fittings and their torque

When screwing fittings into the valves, make sure to tighten them to the proper torque values given below.

● Connection thread: M5

First, tighten by hand, then use a wrench appropriate for the hexagon flats of the body to tighten an additional 1/6 to 1/4 turn. A reference value for the tightening torque is 1 to 1.5 N·m.

- For the fitting with sealant R or NPT, first, tighten it by hand, then use a wrench appropriate for the hexagon flats of the body to tighten it a further two or three turns. For a tightening torque guide, refer to the table below.

Connection thread size (R, NPT)	Proper tightening torque (N·m)
1/8	3 to 5
1/4	8 to 12
3/8	15 to 20
1/2	20 to 25
3/4	28 to 30
1	36 to 38
1 1/4	40 to 42
1 1/2	48 to 50
2	48 to 50

Operating Fluid

⚠ Caution

1. If drainage or debris is present in the supply pressure line, the sliding resistance of the main valve or piston, etc. increases, resulting in a malfunction. Therefore, in addition to the air filter (SMC's AF series), make sure to use a mist separator (SMC's AM, AFM series). Concerning the quality of the operating air, refer to SMC's air preparation equipment selection guide (pages 2 and 3).
2. Make sure to perform a maintenance periodically on air filter and mist separator (by discharging the drain and cleaning a filter element or replacing with new one).

Pressure Gauge

⚠ Caution

For products with pressure gauge, use caution about the durability of a pressure gauge, since it may be affected by the sudden pressure changes during operation.

Wires to be Used

⚠ Caution

Use 3 core shielded wires measuring 0.5 (mm²) for the power supply and signal lines according to the respective number of conductors. When connecting the shielded braided wire, connect it to the ground of the signal generator. As a rule, the electro-pneumatic hybrid regulator should be installed in a location that is free of noise or is shielded. If it must be installed in an environment with poor noise conditions, eliminate the power supply noise by using a line filter, Z-wrap, or a spark killer on the 100 V power supply or signal source line. The length of the power supply and signal lines must be kept as short as possible.

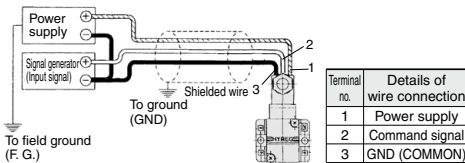

Related Products:

Silencer (AN series)

- Noise reducing effect: 30 dB or more.
- Large effective area
- Refer to Best Pneumatics No. 7 for details.

How to Use DIN Terminal

⚠ Caution

• Wiring procedures

1. Loosen the retaining screw and pull the connector from the solenoid valve terminal block.
2. Remove the retaining screw, insert a flat head screwdriver into the groove below the terminal block and pry it up to separate the terminal block from the housing.
3. Loosen the terminal screws (slot head screws) on the terminal block. Then, in accordance with the wiring procedure, insert the cord of the lead wires into the terminals and tighten the terminal screws to secure in place.
4. Tighten the ground nut to secure the cord.

• Outlet changing procedure

After the terminal block has been separated from its housing, reassemble the housing in the desired direction (in four 90° increments) to change the direction of the cord outlet.

• Precautions

Kindly insert the connector straight in without tilting it, and pull it out straight.

• Applicable wire

Cord external diameter: ø4 to ø6.5
c.f. 0.5 mm² 3 core wire
(JIS C 3306 equivalent)

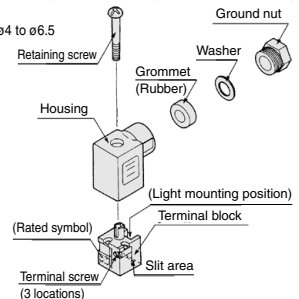

• Connector part no.: VK300-82-1

Input Signal

⚠ Caution

• Input signal when out of operation

There is dispersion in operation start voltage (current) for the input signal. (Refer to page 992.) If the command signal when out of operation exceeds the lower limit of the operation start voltage (current), the solenoid valve inside the pilot valve starts to activate and may be in the operation state. The service life of this product varies depending on the operating time of the solenoid valve inside the pilot valve. Be sure to cut off the command signal when the pressure control on the outlet side is not required, such as when the line is temporarily halted, etc. (Refer to "Service Life" below.)

Service Life

⚠ Caution

The pilot valve service life is approximately 4000 to 5000 operating hours. (When using AF + AFM) This may be approximately 3000 hours with ultra-dry air (dew point -40°C or equivalent). For the low wattage specification (X39), the service life is approximately 7000 operating hours. (When using AF and AFM)

Bleed

⚠ Caution

Since the pilot solenoid valve enters the normally operating status and the air is discharged continuously from the pilot EXH port (port 3 (R) for VY1D00, VY1A0□ and VY1B0□) in the pressure setting status, the bleed sound is produced. However, this is not an abnormal phenomenon.