

Hydraulic Filters

FH□ Series

RoHS

The filters for hydraulic fluids are used to protect each component in a hydraulic circuit.



Series	Operating pressure	Port size	Element (μm) nominal filtration	Accessory (Option)	Page
Vertical Suction Filter FHIA Series	Negative pressure	1/2, 3/4, 1, 1 1/4, 1 1/2, 2, 2 1/2, 3, 3 1/2, 4	Micromesh 74, 105, 149	Differential pressure indicator (CB-□□H) Differential pressure indication switch (CB-□□H) Blanking cap	498
Suction Filter with Case FH99 Series	Negative pressure	1/2, 3/4, 1, 1 1/4, 1 1/2, 2, 2 1/2, 3, 3 1/2, 4	Micromesh 74, 105, 149	Differential pressure indicator (CB-□□H) Differential pressure indication switch (CB-□□H) Blanking cap	502
Suction Guard FHG Series	Negative pressure	1/2, 3/4, 1, 1 1/4, 1 1/2, 2, 2 1/2, 3	Micromesh 74, 105, 149	Differential pressure indicator (CB-□□H) Differential pressure indication switch (CB-□□H) Air breazer Cap	506
Line Filter FH34/44/54/64 Series	Max. 3.5, 7, 14, 21 MPa	3/8, 1/2, 3/4, 1, 1 1/4 1 1/2, 2, 2 1/2, 3	Paper 5, 10, 20 (Micromesh)	Differential pressure indicator (CB-□□H) Differential pressure indication switch (CB-□□H) Blanking cap	510
Vertical Return Filter FHBA Series	Max. 1.6 MPa	3/4, 1 1/4, 1 1/2	Paper 5, 10, 20 Micromesh 5, 10, 20	Differential pressure indicator (CB-□□H) Differential pressure indication switch (CB-□□H) Blanking cap	514
Return Filter FH100 Series	Max. 1 MPa	3/4, 1, 1 1/4, 1 1/2, 2 2 1/2, 3	Paper 5, 10, 20 Micromesh 74, 105	Differential pressure indicator (CB-□□H) Differential pressure indication switch (CB-□□H) Blanking cap	517
Oil Filter FH150 Series	Max. 1 MPa	1/4, 3/8, 1/2	Paper 5, 10, 20 (Micromesh)	Differential pressure indicator (CB-□□H) Differential pressure indication switch (CB-□□H) Blanking cap Bracket	521
Magnetic Separator FHM Series	—	—	—	—	525

Vertical Suction Filter

FHIA Series

RoHS

No air pockets

There are no places for air pockets to form. This prevents damage to the pump and enables normal operation to start immediately.

Elimination of all collected matter

All collected matter can be disposed of reliably when the element is replaced. There is no danger of collected matter dropping back into the tank.

No drain port required

The structure of the filter does not contain areas for drain fluid to collect, so there is no need to manually drain the pump.

Easy element replacement

Simply open the cover to quickly replace the element without touching the pipes. The element is extracted from the top, so no fluid can leak out.

Compact and lightweight

The compact and lightweight design employs an aluminum casted housing.

Clogging sensor

The sensor indicates when the element is becoming clogged, facilitating maintenance and helping to avoid pump damage, such as cavitations.

Differential pressure indicator/reset type

Differential pressure indication switch/visual combined, non-reset type



Specifications

Fluid		Hydraulic fluid
Operating pressure		Negative pressure
Operating temperature		Max. 80°C
Main material	Cover/Case	Aluminum casting
	O-ring	NBR or FKM ^(Note)
	Seal	NBR or EPDM ^(Note)
Element	Material	Stainless steel, Carbon steel, Aluminum, Epoxy resin
	Nominal filtration	74, 105, 149 μm (200, 150, 100 mesh)
	Differential pressure resistance	0.15 MPa
Differential pressure indicator operating pressure (Element replacement differential pressure)		20.0 kPa
Relief valve open pressure		26.7 kPa

(Note) The material of the O-rings and seals differs depending on the hydraulic fluid used.
Petroleum, Water-glycol, Emulsion: NBR; Phosphoric ester: FKM, EPDM

Model/Rated Flow Rate

Model	Flange port size ^(Note)	Rated flow rate (L/min)
FHIA□-04	1/2 ^B	30
FHIA□-06	3/4 ^B	50
FHIA□-08	1 ^B	95
FHIA□-10	1 1/4 ^B	150
FHIA□-12	1 1/2 ^B	220
FHIA□-16	2 ^B	350
FHIA□-20	2 1/2 ^B	550
FHIA□-24	3 ^B	770
FHIA□-28	3 1/2 ^B	1000
FHIA□-32	4 ^B	1300

The symbol represented by □ indicates the type of applicable hydraulic fluid. N: Petroleum, W: Water-glycol, Emulsion, V: Phosphoric ester

(Note) Fitted with companion flange. (Flange configuration is exclusive to SMC.)

Accessory/Option

Description	Part no.	Note
Differential pressure indicator	CB-56H	Petroleum, Water-glycol, Emulsion
	CB-56H-V	Phosphoric ester
Differential pressure indication switch (N.C. and N.O. common)	CB-57H	Petroleum, Water-glycol, Emulsion
	CB-57H-V	Phosphoric ester
Blanking cap (for differential pressure indication part)	AG-12H	Petroleum
	AG-12H-W	Water-glycol, Emulsion
	AG-12H-V	Phosphoric ester

Flow Rate Characteristics

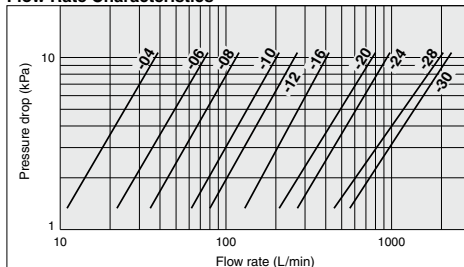

Conditions Fluid: Turbine oil Class 2 VG56
Viscosity: 45 mm²/s
Filter material: Micromesh
Nominal filtration: 74 μm to 149 μm



How to Order

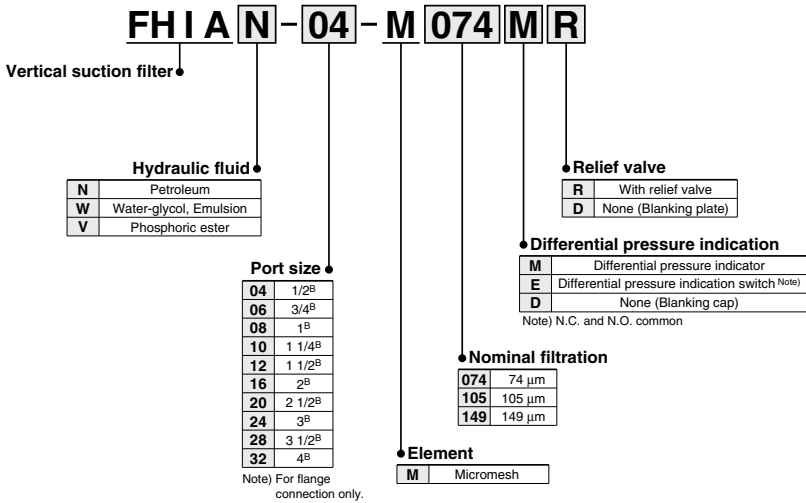

Replacement Element Part No.

Port size (Nominal size)	74 μm (200 mesh)	105 μm (150 mesh)	149 μm (100 mesh)	Element size
04 (1/2 ^B)	EM001H-074N	EM001H-105N	EM001H-149N	ø65 x 90
06 (3/4 ^B), 08 (1 ^B)	EM101H-074N	EM101H-105N	EM101H-149N	ø85 x 110
10 (1 1/4 ^B), 12 (1 1/2 ^B)	EM201H-074N	EM201H-105N	EM201H-149N	ø100 x 160
16 (2 ^B)	EM301H-074N	EM301H-105N	EM301H-149N	ø120 x 180
20 (2 1/2 ^B), 24 (3 ^B)	EM401H-074N	EM401H-105N	EM401H-149N	ø140 x 200
28 (3 1/2 ^B), 32 (4 ^B)	EM501H-074N	EM501H-105N	EM501H-149N	ø180 x 260

Note 1) The symbol at the end of the element part no. indicates the hydraulic fluid type.

N: Petroleum, Phosphoric ester, W: Water-glycol, Emulsion.

Note 2) Above elements require one element per filter.

Differential Pressure Indication

A differential pressure indicator or a differential pressure indication switch can be selected, and mounted on all filter models.

■ Differential pressure indicator

- Operating pressure—20 kPa
- Once a value is displayed, it will continue to be displayed until reset, even if the pump is stopped. (Reset type)
- Perform element replacement when the red ring floats up and covers the entire view port.

■ Differential pressure indication switch

- Operating pressure—20 kPa
- When a value has been displayed, it will be automatically reset when the pump is stopped. (Non-reset type)
- This is a visual dual-purpose. Perform element replacement when the switch has actuated (when the red ring floats up and covers the entire view port).
- N.C. and N.O. common

* Refer to page 529 for "Microswitch for differential pressure indication switch".

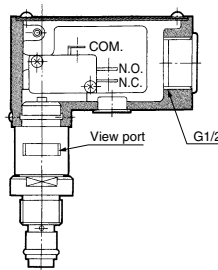
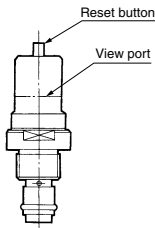

Construction/Seal List

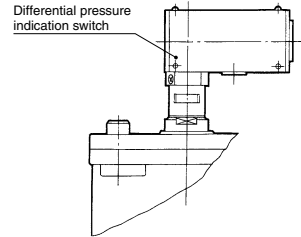
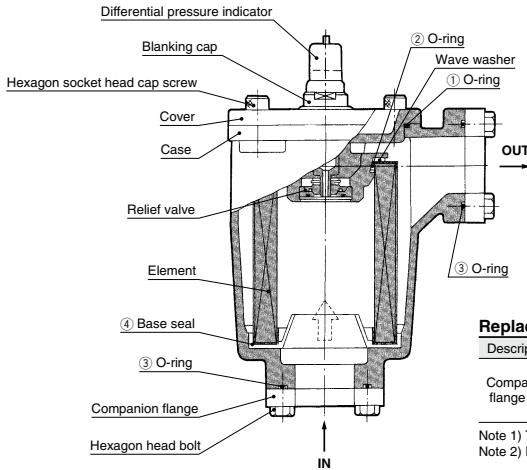

Differential pressure indication switch

Replacement parts

Description	Applicable model	Part no.	Set contents
Companion flange set	FHIAN	FHIA-FL003N -□	Two sets each of companion flange, O-ring, hexagon head bolts
	FHIAW	FHIA-FL003V -□	

Note 1) The two digit number of the port size is entered in the □ of the part number.
 Note 2) Part number N: O-ring material NBR, V: O-ring material FKM

Replacement O-ring/Seal List (Only 1 O-ring or seal is required per filter for options ①, ②, and ④ below; however, for option ③, 2 are required.)

Port size	Applicable hydraulic fluid	Material	① O-ring order no. (Nominal size)	② O-ring order no. (Nominal size)	③ O-ring order no. (Nominal size)	④ Base seal order no.			
04 06 to 08 10 to 12 16 20 to 24 28 to 32	Petroleum, Water-glycol, Emulsion	NBR-70-1	KA00464 (G70)	KA00061 (G35)	KA00458 (G30)	AL-196H			
			KA00466 (G90)	KA00460 (G50)	KA00062 (G45)		AL-197H		
			KA00453 (G105)	KA00463 (G65)	KA00461 (G55)			AL-198H	
			KA00787 (G125)	KA00465 (G80)	KA00464 (G70)		AL-199H		
			KA00060 (G145)	KA00452 (G100)	KA00065 (G95)	AL-200H			
			KA00792 (G185)	KA00790 (G140)	KA00787 (G125)	AL-201H			
			04 06 to 08 10 to 12 16 20 to 24 28 to 32	Phosphoric ester	FKM-70 or EPDM-70	KA00616 (G70)	KA00696 (G35)	KA00695 (G30)	AL-196H-V
						KA00704 (G90)	KA00699 (G50)	KA00698 (G45)	AL-197H-V
KA00688 (G105)	KA00614 (G65)	KA00700 (G55)				AL-198H-V			
KA00689 (G125)	KA00702 (G80)	KA00616 (G70)				AL-199H-V			
KA00692 (G145)	KA00610 (G100)	KA00705 (G95)				AL-200H-V			
KA00693 (G185)	KA00691 (G140)	KA00689 (G125)				AL-201H-V			

Note) The material of seals (AL-196H-V to AL-201H-V) is EPDM-70.
 Note) The material and nominal size notations are based on JISB2401.

Handling Precautions

① Mounting

- Confirm IN and OUT before connecting.
- For maintenance, make sure to provide sufficient space above the filter for removing the element.

② Operation

- The hydraulic fluid used becomes high viscosity when the temperature is low during the winter, etc., and the differential pressure indicator or the switch may activate. If this occurs, wait until the oil temperature rises by a warm-up operation, then check if this is caused by clogging.
- If the differential pressure indicator is the reset type, make sure to reset it after normal operation starts in cold weather such as during winter.
- When using a differential pressure indication switch, if a filter clogged signal is incorporated into the sequence circuit of the machine, make sure to design the system so the filter clogged signal does not operate until normal operation starts.

③ Element replacement

- When the pressure difference reaches 20 kPa during filter operation (actuating the differential pressure indicator), stop operation and either wash or replace the element.
- If any scratches or damage are found on the O-ring during assembly/disassembly, replace with a new O-ring.
- When washing the element, do not wipe it using a stiff brush or rag.
- After washing the element, make sure the base seal is properly mounted.

Dimensions

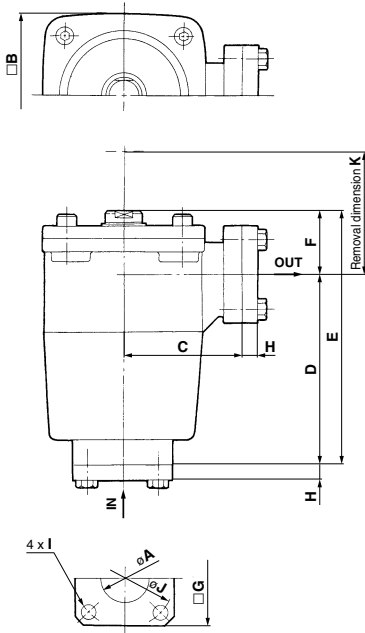

Differential pressure indicator

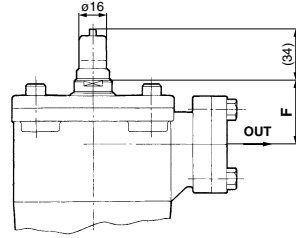

Differential pressure indication switch

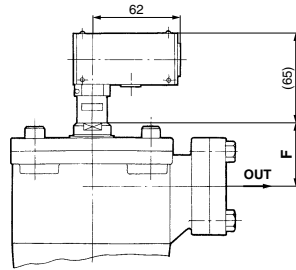

FH □
HOW □

Model	A	B	C	D	E	F	G	H	I	J	K	Weight (kg)
FHIA □-04	22.2	90	72	116	154	38	60	11	M8 x 25	56	260	1.8
FHIA □-06	27.7	110	80	133	177	44	70	11	M8 x 25	70	290	2.7
FHIA □-08	34.5		95	185	234	49	86	15	M10 x 30	86	340	4.6
FHIA □-10	43.2	128	95	185	234	49	86	15	M10 x 30	86	340	4.6
FHIA □-12	49.1	176	125	220	290.5	70.5	120	15	M12 x 35	130	410	9.5
FHIA □-16	61.1		152	110	214	268.5	54.5	100	15	M12 x 35	102	370
FHIA □-20	77.1	224	125	220	290.5	70.5	120	15	M12 x 35	130	410	8.0
FHIA □-24	90.0		155	280	364.5	84.5	150	15	M16 x 40	166	490	14.0
FHIA □-28	102.6	224	155	280	364.5	84.5	150	15	M16 x 40	166	490	14.0
FHIA □-32	115.4		176	125	220	290.5	70.5	120	15	M12 x 35	130	410

(1) Contact specifications

Table 1 Contact specifications

Item	Specifications
Inrush current	Max. 15 A
Minimum applicable load	5 VDC 160 mA

(2) Rating

Table 2 Rating

Rated voltage	Resistance load
250 VAC	5 A

(3) Other performance

Table 3 Other specifications

Item	Specifications	
Insulation resistance	100 MΩ or more (Measured by 500 VDC, insulation resistance tester.)	
Contact resistance	30 mΩ or less	
Withstand voltage	Between terminals with the same pole.	1,000 VAC 50/60 Hz 1 min
	Between charged metal part and ground	1,500 VAC 50/60 Hz 1 min
	Between each terminal and non-charged metal part	1,500 VAC 50/60 Hz 1 min

(4) Electric circuit

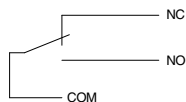

(N.C. and N.O. common)

Precautions

1. Connect desired wiring to the micro switch indication symbols 1 (COM.), 2 (N.C.), and 3 (N.O.).
2. When a protection mechanism is required, take appropriate considerations on the electric circuit since the micro switch is a type of non-reset.

(5) Terminal type

Soldering terminal