

Vacuum Ejector

ZH Series

Body Ported Type/Box Type (Built-in Silencer)

RoHS

Compact and lightweight

Body ported type

Port size: G threads have been added.



Overall length Max. **12%** reduction
(6.7 mm shorter)

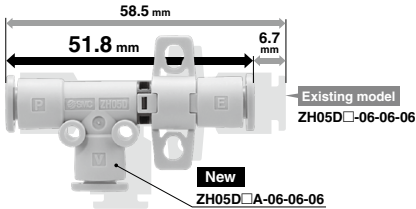

Port height Max. **26%** reduction
(9.1 mm shorter)

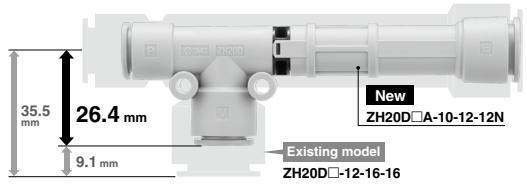

Weight Max. **74%** reduction Existing model 88.4 g ▶ New 23.3 g
(65.1 g lighter)

Box type (Built-in silencer)



Volume Max. **39%** reduction Existing model ZH10B□-06-06
(14.1 cm³ reduction)

Existing model 36.3 cm³ ▶ New 22.2 cm³

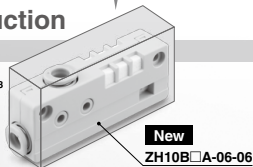

Port height Max. **20%** reduction
(4.6 mm shorter)







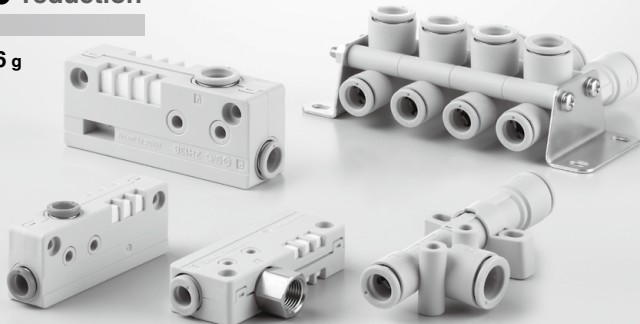
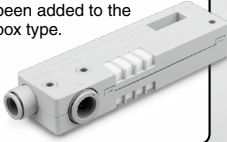

Weight Max. **59%** reduction
(19.4 g lighter)

Existing model 33 g ▶ New 13.6 g

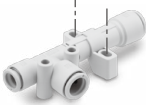
Nozzle sizes
ø1.5, ø1.8, and ø2.0 have
been added to the
box type.

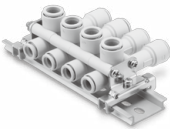

4 mounting types

Body type	Direct mounting	Standard bracket mounting	L-bracket mounting	DIN rail mounting
Body ported type				
Box type (Built-in silencer)	<p>ZH05 to 13</p>  <p>ZH15 to 20</p>  <p>---: Body mounting - - -: Cover mounting</p> <p>* For ZH15, 18, and 20, mount using 2 of the 3 mounting holes.</p>	— (Not available)		

Easy identification of product type



A silencer and standard bracket are available.

* Shipped together with the product

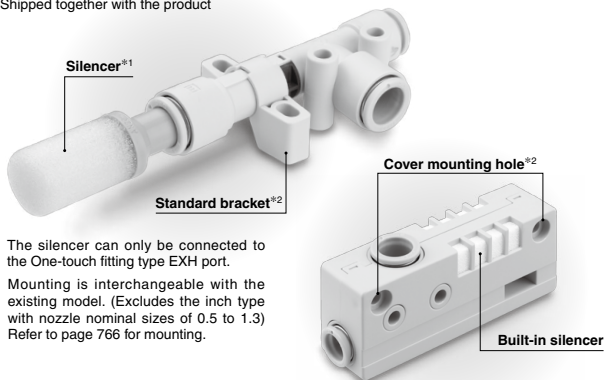

*1 The silencer can only be connected to the One-touch fitting type EXH port.

*2 Mounting is interchangeable with the existing model. (Excludes the inch type with nozzle nominal sizes of 0.5 to 1.3) Refer to page 766 for mounting.

Variations

Body type	Model	Nozzle nominal size [mm]	Vacuum pressure reached* ¹ [kPa]		Maximum suction flow rate [L/min (ANR)]		Air consumption [L/min (ANR)]
			Type S	Type L	Type S	Type L	
Body ported type	ZH05D□A	0.5	-90		6	13	13
	ZH07D□A	0.7			12	28	27
	ZH10D□A	1.0			26	52	52
	ZH13D□A	1.3			40	78	88
	ZH15D□A	1.5			58	78	117
	ZH18D□A	1.8			76	128	165
Box type (Built-in silencer)	ZH20D□A	2.0	-89	-48	90	155	201
	ZH05B□A	0.5			6	13	13
	ZH07B□A	0.7			12	28	27
	ZH10B□A	1.0			26	52	52
	ZH13B□A	1.3	40	78	88		
	ZH15B□A	1.5	58	78	117		
	ZH18B□A	1.8	76	128	165		
	ZH20B□A	2.0	-90	-66	90	155	201

*1 Supply pressure: 0.45 MPa

Piping Variations

One-touch connections

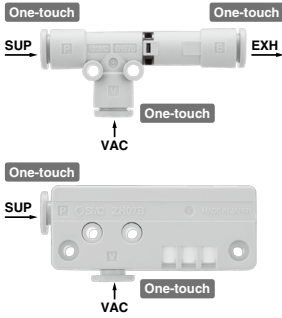

Body ported type

Box type

Metric

SUP	VAC	EXH	Model
ø6*1	ø6*1	ø6*1	ZH05D□ ZH07D□
ø6*1	ø6*1	ø8	ZH10D□
ø8	ø10	ø10	ZH13D□ ZH15D□
ø10	ø12	ø12	ZH18D□ ZH20D□

SUP	VAC	Model
ø6*1	ø6*1	ZH05B□ ZH07B□ ZH10B□
ø8	ø10	ZH13B□ ZH15B□
ø10	ø12	ZH18B□ ZH20B□

*1 The oval release button is only available for ø6.

Inch

SUP	VAC	EXH	Model
ø1/4"	ø1/4"	ø1/4"	ZH05D□ ZH07D□
ø1/4"	ø1/4"	ø5/16"	ZH10D□
ø5/16"	ø3/8"	ø3/8"	ZH13D□ ZH15D□
ø3/8"	ø1/2"	ø1/2"	ZH18D□ ZH20D□

SUP	VAC	Model
ø1/4"	ø1/4"	ZH05B□ ZH07B□ ZH10B□
ø5/16"	ø3/8"	ZH13B□ ZH15B□
ø3/8"	ø1/2"	ZH18B□ ZH20B□

One-touch and screw-in connections

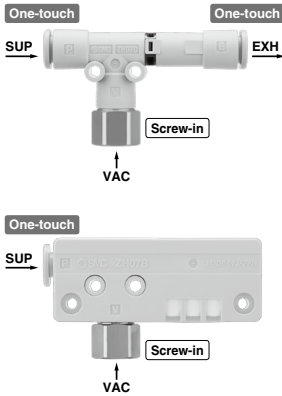

Body ported type

Box type

SUP	VAC	EXH	Model
ø6*1	Rc1/8 G1/8	ø6*1	ZH05D□ ZH07D□
ø6*1	Rc1/8 G1/8	ø8	ZH10D□
ø8	Rc1/4 G1/4	ø10	ZH13D□
ø8	Rc3/8 G3/8	ø10	ZH15D□
ø10	Rc3/8 G3/8	ø12	ZH18D□
ø10	Rc1/2 G1/2	ø12	ZH20D□

SUP	VAC	Model
ø6*1	Rc1/8 G1/8	ZH05B□ ZH07B□ ZH10B□
ø8	Rc1/4 G1/4	ZH13B□
ø8	Rc3/8 G3/8	ZH15B□
ø10	Rc3/8 G3/8	ZH18B□
ø10	Rc1/2 G1/2	ZH20B□

*1 The oval release button is only available for ø6.

SUP	VAC	EXH	Model
ø1/4"	NPT1/8	ø1/4"	ZH05D□ ZH07D□
ø1/4"	NPT1/8	ø5/16"	ZH10D□
ø5/16"	NPT1/4	ø3/8"	ZH13D□
ø5/16"	NPT3/8	ø3/8"	ZH15D□
ø3/8"	NPT3/8	ø1/2"	ZH18D□
ø3/8"	NPT1/2	ø1/2"	ZH20D□

SUP	VAC	Model
ø1/4"	NPT1/8	ZH05B□ ZH07B□ ZH10B□
ø5/16"	NPT1/4	ZH13B□
ø5/16"	NPT3/8	ZH15B□
ø3/8"	NPT3/8	ZH18B□
ø3/8"	NPT1/2	ZH20B□

Screw-in connections

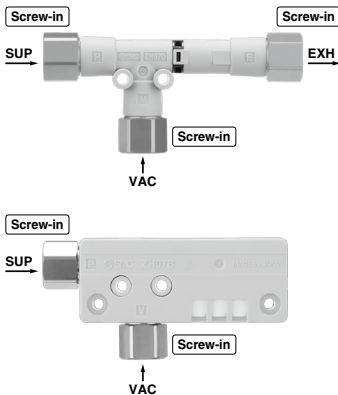

Body ported type

Box type

SUP	VAC	EXH	Model
Rc1/8 G1/8	Rc1/8 G1/8	Rc1/8 G1/8	ZH05D□ ZH07D□ ZH10D□
Rc1/8 G1/8	Rc1/4 G1/4	Rc1/4 G1/4	ZH13D□
Rc1/4 G1/4	Rc3/8 G3/8	Rc3/8 G3/8	ZH15D□
Rc3/8 G3/8	Rc3/8 G3/8	Rc3/8 G3/8	ZH18D□
Rc3/8 G3/8	Rc1/2 G1/2	Rc1/2 G1/2	ZH20D□

SUP	VAC	Model
Rc1/8 G1/8	Rc1/8 G1/8	ZH05B□ ZH07B□ ZH10B□
Rc1/8 G1/8	Rc1/4 G1/4	ZH13B□
Rc1/4 G1/4	Rc3/8 G3/8	ZH15B□
Rc3/8 G3/8	Rc3/8 G3/8	ZH18B□
Rc3/8 G3/8	Rc1/2 G1/2	ZH20B□

SUP	VAC	EXH	Model
NPT1/8	NPT1/8	NPT1/8	ZH05D□ ZH07D□ ZH10D□
NPT1/8	NPT1/4	NPT1/4	ZH13D□
NPT1/4	NPT3/8	NPT3/8	ZH15D□
NPT3/8	NPT3/8	NPT3/8	ZH18D□
NPT3/8	NPT1/2	NPT1/2	ZH20D□

SUP	VAC	Model
NPT1/8	NPT1/8	ZH05B□ ZH07B□ ZH10B□
NPT1/8	NPT1/4	ZH13B□
NPT1/4	NPT3/8	ZH15B□
NPT3/8	NPT3/8	ZH18B□
NPT3/8	NPT1/2	ZH20B□

CONTENTS

Vacuum Ejector Body Ported Type/Box Type (Built-in Silencer) *ZH Series*

How to Order: Body Ported Type	p. 749
How to Order: Box Type (Built-in Silencer)	p. 750
L-Bracket / DIN Rail Mounting Bracket	p. 751
Specifications	p. 752
Construction	p. 752
Exhaust Characteristics / Flow Rate Characteristics (Representative Value)	p. 753

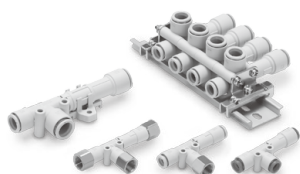

Dimensions: **Body Ported Type**

One-touch Connections	p. 755
Standard Bracket	p. 755
One-touch and Screw-in Connections	p. 756
Screw-in Connections	p. 757
L-Bracket	p. 758
DIN Rail Mounting Bracket	p. 759

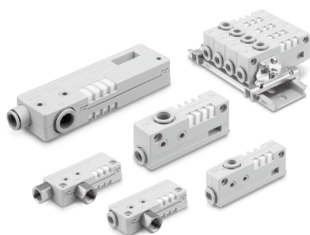

Dimensions: **Box Type (Built-in Silencer)**

One-touch Connections	p. 760
One-touch and Screw-in Connections	p. 761
Screw-in Connections	p. 762
L-Bracket	p. 763
DIN Rail Mounting Bracket	p. 764

Circuit Examples	p. 765
Specific Product Precautions	p. 766

Body Ported Type Vacuum Ejector ZH Series

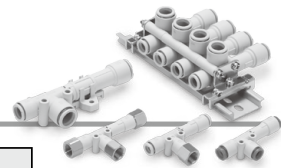

How to Order

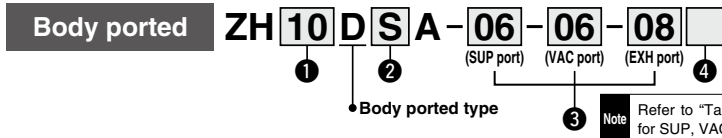

1 Nozzle size

Nozzle size	Symbol
05	ø0.5
07	ø0.7
10	ø1.0
13	ø1.3
15	ø1.5
18	ø1.8
20	ø2.0

2 Vacuum pressure reached

Vacuum pressure reached	Note
S -90 kPa	ZH05 to 20
L -48 kPa	ZH05 to 13
-66 kPa	ZH15 to 20

3 Port (SUP/VAC/EXH) size

One-touch fittings

Metric size	Inch size
06	ø6
08	ø8
10	ø10
12	ø12
07	ø1/4"
09	ø5/16"
11	ø3/8"
13	ø1/2"

Female threads

Metric size	Inch size
01	Rc1/8
02	Rc1/4
03	Rc3/8
04	Rc1/2
F01	G1/8
F02	G1/4
F03	G3/8
F04	G1/2
N01	NPT1/8
N02	NPT1/4
N03	NPT3/8
N04	NPT1/2

4 Accessories (Standard bracket/Silencer)*4

Symbol	Standard bracket	Silencer
Nii	×	×
N	●	×
S*3	●	●
NS*3	×	●

*3 Options S and NS are not available for EXH port with a screw-in connection.

*4 Each accessory is not assembled with the product but shipped together.

Standard bracket

Applicable model	ZH05 to 10D□A	ZH13/15D□A	ZH18/20D□A
Model	ZH2-BK1A-1-A	ZH2-BK1A-2-A	ZH2-BK1A-3-A

Silencer



• Silencer can only be selected for EXH port with One-touch fitting.
• The silencer part number depends on the size of the EXH port.

EXH port	Silencer part no.
06	AN10-C06
07	AN10-C07
08	AN15-C08
09	AN15-C08
10	AN20-C10
11	AN20-C11
12	AN30-C12

* No silencer available for ZH18/20D□A in inch size for EXH port size '13'

In that case, select the screw-in connection, and order silencer AN30-N03 and AN40-N04 separately

For details about silencers, refer to the AN series in the Web Catalog.

Table 1 Body ported SUP/VAC/EXH port size

Model	Metric Size			Inch Size		
	SUP	VAC	EXH	SUP	VAC	EXH
ZH05D□A-	06 - 06 - 06	06	06	06	06	06
	06 - 01 - 06	06	06	06	Rc1/8	06
	06 - F01 - 06	06	06	06	G1/8	06
	01 - 01 - 01	Rc1/8	Rc1/8	Rc1/8	Rc1/8	Rc1/8
ZH07D□A-	06 - 06 - 06	06	06	06	06	06
	06 - 01 - 06	06	06	06	Rc1/8	06
	06 - F01 - 06	06	06	06	G1/8	06
	01 - 01 - 01	Rc1/8	Rc1/8	Rc1/8	Rc1/8	Rc1/8
ZH10D□A-	06 - 06 - 08	06	08	06	08	08
	06 - 01 - 08	06	08	06	Rc1/8	08
	06 - F01 - 08	06	08	06	G1/8	08
	01 - 01 - 01	Rc1/8	Rc1/8	Rc1/8	Rc1/8	Rc1/8
ZH13D□A-	F01 - F01 - F01	G1/8	G1/8	G1/8	G1/8	G1/8
	08 - 10 - 10	08	10	08	10	10
	08 - 02 - 10	08	10	08	Rc1/4	10
	08 - F02 - 10	08	10	08	G1/4	10
ZH15D□A-	01 - 02 - 02	Rc1/8	Rc1/4	Rc1/8	Rc1/4	Rc1/4
	F01 - F02 - F02	G1/8	G1/4	G1/8	G1/4	G1/4
	08 - 10 - 10	08	10	08	10	10
	08 - 03 - 10	08	10	08	Rc3/8	10
ZH18D□A-	08 - F03 - 10	08	10	08	G3/8	10
	02 - 03 - 03	Rc1/4	Rc3/8	Rc1/4	Rc3/8	Rc3/8
	F02 - F03 - F03	G1/4	G3/8	G1/4	G3/8	G3/8
	10 - 12 - 12	10	12	10	12	12
ZH20D□A-	10 - 03 - 12	10	12	10	Rc3/8	12
	10 - F03 - 12	10	12	10	G3/8	12
	03 - 03 - 03	Rc3/8	Rc3/8	Rc3/8	Rc3/8	Rc3/8
	F03 - F03 - F03	G3/8	G3/8	G3/8	G3/8	G3/8
ZH20D□A-	10 - 12 - 12	10	12	10	12	12
	10 - 04 - 12	10	12	10	Rc1/2	12
	10 - F04 - 12	10	12	10	G1/2	12
	03 - 04 - 04	Rc3/8	Rc1/2	Rc3/8	Rc1/2	Rc1/2
ZH20D□A-	F03 - F04 - F04	G3/8	G1/2	G3/8	G1/2	G1/2

*1 Screw-in: Rc and G female threads

Inch Size

Model	Metric Size			Inch Size		
	SUP	VAC	EXH	SUP	VAC	EXH
ZH05D□A-	07 - 07 - 07	07	07	07	07	07
	07 - N01 - 07	07	07	07	07	07
	N01 - N01 - N01	NPT1/8	NPT1/8	NPT1/8	NPT1/8	NPT1/8
ZH07D□A-	07 - 07 - 07	07	07	07	07	07
	07 - N01 - 07	07	07	07	07	07
	N01 - N01 - N01	NPT1/8	NPT1/8	NPT1/8	NPT1/8	NPT1/8
ZH10D□A-	07 - 07 - 09	07	09	07	09	09
	07 - N01 - 09	07	09	07	09	09
	N01 - N01 - N01	NPT1/8	NPT1/8	NPT1/8	NPT1/8	NPT1/8
ZH13D□A-	09 - 11 - 11	09	11	09	11	11
	09 - N02 - 11	09	11	09	11	11
	N01 - N02 - N02	NPT1/8	NPT1/4	NPT1/8	NPT1/4	NPT1/4
ZH15D□A-	09 - 11 - 11	09	11	09	11	11
	09 - N03 - 11	09	11	09	11	11
	N02 - N03 - N03	NPT1/4	NPT3/8	NPT1/4	NPT3/8	NPT3/8
ZH18D□A-	11 - 13 - 13	11	13	11	13	13
	11 - N03 - 13	11	13	11	13	13
	N03 - N03 - N03	NPT3/8	NPT3/8	NPT3/8	NPT3/8	NPT3/8
ZH20D□A-	11 - 13 - 13	11	13	11	13	13
	11 - N04 - 13	11	13	11	13	13
	N03 - N04 - N04	NPT3/8	NPT1/2	NPT3/8	NPT1/2	NPT1/2

*2 Screw-in: NPT female threads

Box Type (Built-in Silencer) Vacuum Ejector

ZH Series



How to Order

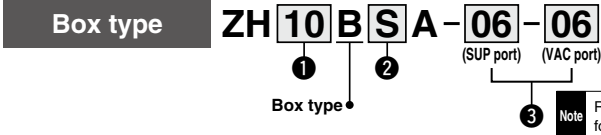

Box type (Built-in silencer)

Note Refer to "Table 2" for the combination available for SUP and VAC port connection.

① Nozzle size

Nozzle size	
05	ø0.5
07	ø0.7
10	ø1.0
13	ø1.3
15	ø1.5
18	ø1.8
20	ø2.0

② Vacuum pressure reached

	Pressure	Model
S	-89 kPa	ZH05 to 13
	-90 kPa	ZH15 to 20
L	-48 kPa	ZH05 to 13
	-66 kPa	ZH15 to 18
	-62 kPa	ZH20

③ Port (SUP/VAC) size

One-touch fittings	
Metric size	Inch size
06	ø6
08	ø8
10	ø10
12	ø12
07	ø1/4"
09	ø5/16"
11	ø3/8"
13	ø1/2"

Female threads

Metric size	Inch size
01	Rc1/8
02	Rc1/4
03	Rc3/8
04	Rc1/2
F01	G1/8
F02	G1/4
F03	G3/8
F04	G1/2
N01	NPT1/8
N02	NPT1/4
N03	NPT3/8
N04	NPT1/2

Table 2 **Box type (Built-in silencer) SUP/VAC port size**

Model	SUP		VAC	
	SUP	VAC	SUP	VAC
ZH05B□A-	06	- 06	ø6	ø6
	06	- 01	ø6	Rc1/8
	06	- F01	ø6	G1/8
	01	- 01	Rc1/8	Rc1/8
	F01	- F01	G1/8	G1/8
ZH07B□A-	06	- 06	ø6	ø6
	06	- 01	ø6	Rc1/8
	06	- F01	ø6	G1/8
	01	- 01	Rc1/8	Rc1/8
	F01	- F01	G1/8	G1/8
ZH10B□A-	06	- 06	ø6	ø6
	06	- 01	ø6	Rc1/8
	06	- F01	ø6	G1/8
	01	- 01	Rc1/8	Rc1/8
	F01	- F01	G1/8	G1/8
ZH13B□A-	08	- 10	ø8	ø10
	08	- 02	ø8	Rc1/4
	08	- F02	ø8	G1/4
	01	- 02	Rc1/8	Rc1/4
	F01	- F02	G1/8	G1/4
ZH15B□A-	08	- 10	ø8	ø10
	08	- 03	ø8	Rc3/8
	06	- F03	ø8	G3/8
	02	- 03	Rc1/4	Rc3/8
	F02	- F03	G1/4	G3/8
ZH18B□A-	10	- 12	ø10	ø12
	10	- 03	ø10	Rc3/8
	10	- F03	ø10	G3/8
	03	- 03	Rc3/8	Rc3/8
	F03	- F03	G3/8	G3/8
ZH20B□A-	10	- 12	ø10	ø12
	10	- 04	ø10	Rc1/2
	10	- F04	ø10	G1/2
	03	- 04	Rc3/8	Rc1/2
	F03	- F04	G3/8	G1/2

Inch size *5

Model	SUP		VAC	
	SUP	VAC	SUP	VAC
ZH05B□A-	07	- 07	ø1/4"	ø1/4"
	07	- N01	ø1/4"	NPT1/8
	N01	- N01	NPT1/8	NPT1/8
ZH07B□A-	07	- 07	ø1/4"	ø1/4"
	07	- N01	ø1/4"	NPT1/8
	N01	- N01	NPT1/8	NPT1/8
ZH10B□A-	07	- 07	ø1/4"	ø1/4"
	07	- N01	ø1/4"	NPT1/8
	N01	- N01	NPT1/8	NPT1/8
ZH13B□A-	09	- 11	ø5/16"	ø3/8"
	09	- N02	ø5/16"	NPT1/4
	N01	- N02	NPT1/8	NPT1/4
ZH15B□A-	09	- 11	ø5/16"	ø3/8"
	09	- N03	ø5/16"	NPT3/8
	N02	- N03	NPT1/4	NPT3/8
ZH18B□A-	11	- 13	ø3/8"	ø1/2"
	11	- N03	ø3/8"	NPT3/8
	N03	- N03	NPT3/8	NPT3/8
ZH20B□A-	11	- 13	ø3/8"	ø1/2"
	11	- N04	ø3/8"	NPT1/2
	N03	- N04	NPT3/8	NPT1/2

*6 Screw-in: NPT female threads

*5 Screw-in: Rc and G female threads



L-Bracket / DIN Rail Mounting Bracket

When using the ejectors with a clamp mount, order parts ①, ②, and ③ below separately.

① L-Bracket

Part no.	Applicable model	Note	Quantity
AS-10L	ZH05/07/10□□A	Applicable thread size: M3	1 pc.
AS-25L	ZH13□□A/15□□A	Applicable thread size: M4	
AS-30L	ZH18/20□□A	Applicable thread size: M4	

② DIN Rail Mounting Bracket*1

Part no.	Applicable model	Note	Quantity
AS-10D	ZH05/07/10□□A	Applicable thread size: M3	1 pc.
AS-25D	ZH13□□A/15□□A	Applicable thread size: M4	
AS-30D	ZH18/20□□A	Applicable thread size: M4	

*1 DIN rail is not included. It should be provided by the customer.

DIN rail

AXT100 - DR - 5

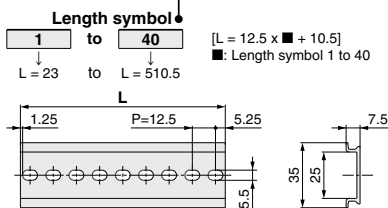

Body ported type

③ Set of long clamping screws (1 set/2 pcs. included)

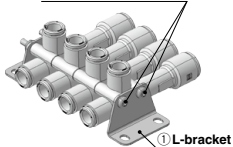

Box type

③ Set of long clamping screws (1 set/2 pcs. included)

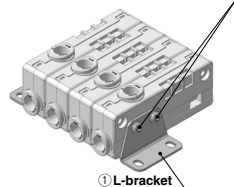

③ Set of long clamping screws (1 set/2 pcs. included)

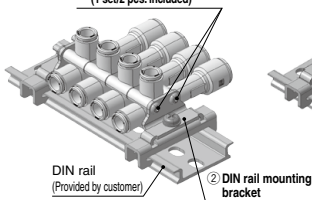

③ Set of long clamping screws (1 set/2 pcs. included)

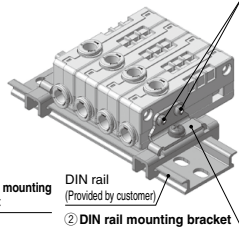

L Dimensions

No.	1	2	3	4	5	6	7	8	9	10	11	12	13	14	15	16	17	18	19	20
L Dimension	23	35.5	48	60.5	73	85.5	98	110.5	123	135.5	148	160.5	173	185.5	198	210.5	223	235.5	248	260.5
No.	21	22	23	24	25	26	27	28	29	30	31	32	33	34	35	36	37	38	39	40
L Dimension	273	285.5	298	310.5	323	335.5	348	360.5	373	385.5	398	410.5	423	435.5	448	460.5	473	485.5	498	510.5

③ Set of Long Clamping Screws*1

Part no.	Applicable model	Stations	Contents*2		
			Screw	Accessories	
ZH2-TB101-A	ZH05□□A	1	M3 x 20	2 pcs. Hexagon nut (M3) 2 pcs.	
ZH2-TB102-A		2	M3 x 35		
ZH2-TB103-A		3	M3 x 50	2 pcs. Flat washer (for M3) 2 pcs.	
ZH2-TB104-A		4	M3 x 65		
ZH2-TB106-A	ZH10□□A	6	M3 x 95	2 pcs. Hexagon nut (M4) 2 pcs.	
ZH2-TB108-A		8	M3 x 125		
ZH2-TB201-A		ZH13□□A	1	M4 x 30	2 pcs. Hexagon nut (M4) 2 pcs.
ZH2-TB202-A			2	M4 x 50	
ZH2-TB203-A	ZH15□□A		3	M4 x 70	2 pcs. Flat washer (for M4) 2 pcs.
ZH2-TB204-A			4	M4 x 90	
ZH2-TB206-A	ZH18□□A	6	M4 x 130	2 pcs. Hexagon nut (M4) 2 pcs.	
ZH2-TB208-A		8	M4 x 170		
ZH2-TB301-A*13		ZH20□□A	1	M4 x 30	2 pcs. Flat washer (for M4) 2 pcs.
ZH2-TB302-A			2	M4 x 55	
ZH2-TB303-A	3		M4 x 80	2 pcs. Hexagon nut (M4) 2 pcs.	
ZH2-TB304-A	4		M4 x 100		
ZH2-TB306-A	ZH18□□A	6	M4 x 145	2 pcs. Flat washer (for M4) 2 pcs.	
ZH2-TB308-A		8	M4 x 185		

*1 Select only One-touch fitting if ZH ejectors are to be clamped. The screw-in connectors cannot be used as they will interfere with each other when clamped together. Refer to pages 758 and 759 to find the models for which clamp mounting is not available.

*2 The material of the nut and bolt is carbon steel with a trivalent chromate surface treatment.

*3 The same screw set is used for 1 station of ZH13□□A/15□□A and ZH18/20□□A.

Ordering Example*1

ZH10DSA 4 products are clamped with L-bracket.

- ① ZH10DSA-06-06-08N 4 pcs.
- ② AS-10L 2 pcs.
- ③ ZH2-TB104-A 1 set (2 pcs. included)

*1 The products are not assembled. M3: Assemble the products with 0.315 ± 0.03 N·m, M4: 0.76 ± 0.08 N·m.

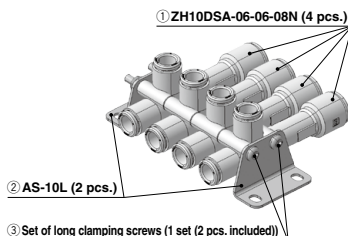

ZH Series



Body ported type



Box type
(Built-in silencer)

Symbol



Specifications

Operating temperature range	-5 to 50°C*1
Fluid	Air
Applicable tubing material	FEP, PFA, Nylon, Soft nylon, Polyurethane
Operating pressure range	0.1 to 0.6 MPa*2

*1 No freezing

*2 This is the supply pressure to the supply (P) port. The vacuum (V) and exhaust (E) ports should not be sealed simultaneously.

Ejector Specifications*1

Model	Nozzle nominal size [mm]	Vacuum pressure reached*2 [kPa]		Maximum suction flow rate [L/min (ANR)]		Air consumption [L/min (ANR)]	Weight*3 [g]
		Type S	Type L	Type S	Type L		
ZH05D□A	0.5	-90	-48	6	13	13	5.0
ZH07D□A	0.7			12	28	27	5.2
ZH10D□A	1.0			26	52	52	6.1
ZH13D□A	1.3			40	78	88	12.4
ZH15D□A	1.5			58	78	117	13.4
ZH18D□A	1.8			76	128	165	22.2
ZH20D□A	2.0	90	155	201	23.3		
ZH05B□A	0.5	-89	-48	6	13	13	12.3
ZH07B□A	0.7			12	28	27	12.4
ZH10B□A	1.0			26	52	52	13.6
ZH13B□A	1.3			40	78	88	26.9
ZH15B□A	1.5			58	78	117	28.7
ZH18B□A	1.8			76	128	165	46.4
ZH20B□A	2.0	-62	90	155	201	46.2	

*1 The values indicating characteristics are representative values and may vary depending on the atmospheric pressure (weather, altitude, etc.).

*2 Supply pressure: 0.45 MPa

*3 Weight for the One-touch fitting type (Excludes the standard bracket)

Construction

Body ported type

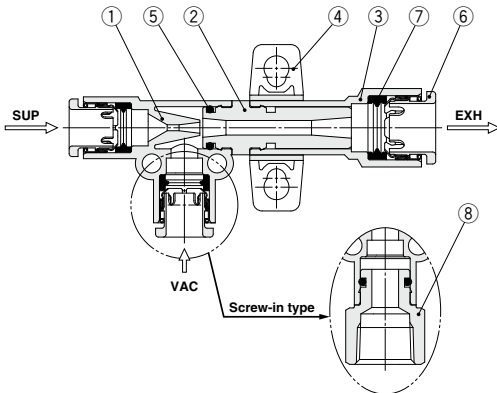

Box type

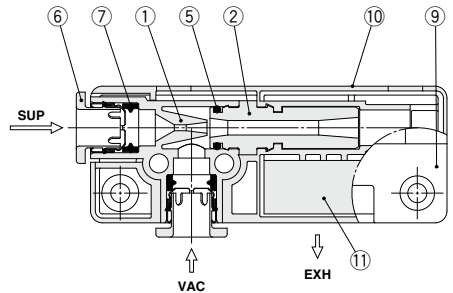

Component Parts

No.	Description	Material	Note
1	Body	PBT	
2	Diffuser	PPS	Type S: Brown, Type L: Black
3	Adapter	PBT	
4	Standard bracket*1	NBR	Detachable (Accessory)
5	O-ring	NBR	Grease applied
6	Cassette	—	

No.	Description	Material	Note
7	Seal	NBR	Grease applied
8	Screw-in stud	Brass	Electroless nickel plating
9	Cover A	PBT	
10	Cover B	PBT	With identification mark for type S or type L (Refer to page 768 for details.)
11	Sound absorbing material	Resin	

*1 Refer to page 749 for the order number.

Exhaust Characteristics / Flow Rate Characteristics (Representative Value)

(Flow rate characteristics:
Supply pressure: 0.45 MPa)

ZH15□SA

Exhaust Characteristics

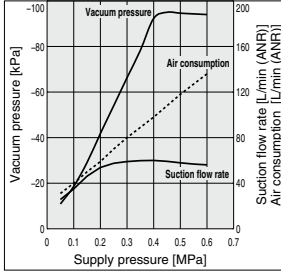

Flow Rate Characteristics

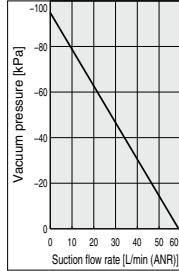

ZH15□LA

Exhaust Characteristics

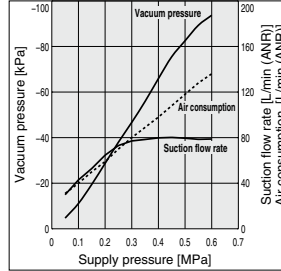

Flow Rate Characteristics

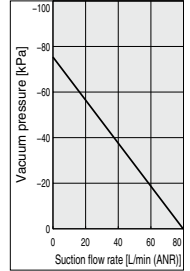

ZH18□SA

Exhaust Characteristics

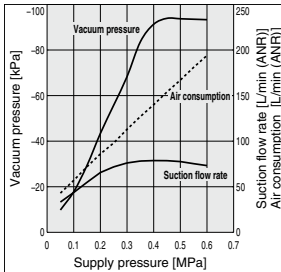

Flow Rate Characteristics

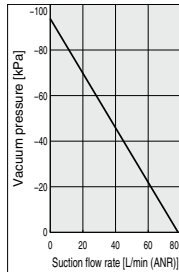

ZH18□LA

Exhaust Characteristics

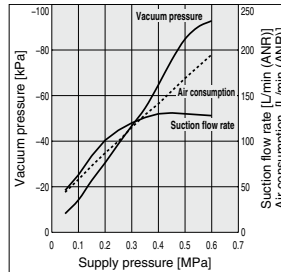

Flow Rate Characteristics

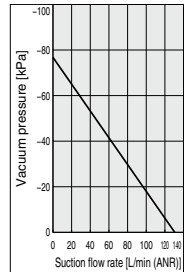

ZH20□SA

Exhaust Characteristics

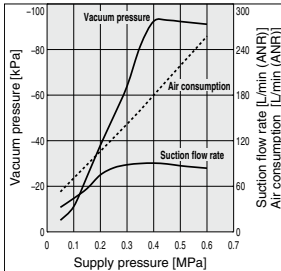

Flow Rate Characteristics

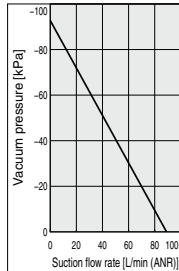

ZH20□LA

Exhaust Characteristics

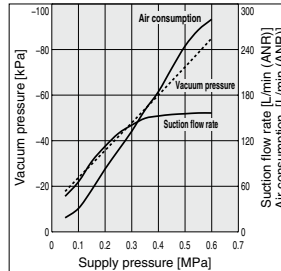

Flow Rate Characteristics

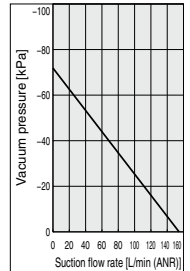

How to Read Flow Rate Characteristics Graph

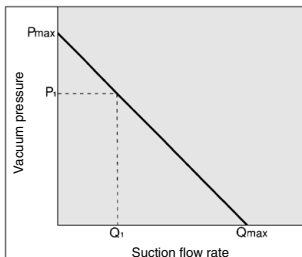

Flow rate characteristics are expressed in ejector vacuum pressure and suction flow. If suction flow changes, the vacuum pressure will also be changed. Normally this relationship is expressed in ejector standard operating pressure use. In the graph, Pmax is maximum vacuum pressure and Qmax is maximum suction flow. The values are specified according to catalog use. Changes in vacuum pressure are expressed in the below order.

1. When the ejector suction port is covered and made airtight, the suction flow becomes zero and vacuum pressure is at the maximum value (Pmax).
2. When the suction port is opened gradually, air can flow through, (air leakage), suction flow increases, but vacuum pressure decreases. (condition P1 and Q1)

3. When the suction port is opened further and fully opened, suction flow moves to the maximum value (Qmax), but vacuum pressure is near zero (atmospheric pressure).

As described above, the vacuum pressure changes when the suction flow changes. In other words, when there is no leakage from the vacuum port, the vacuum pressure can reach its maximum, but as the amount of leakage increases, the vacuum pressure decreases. When the amount of leakage and the maximum suction flow become equal, the vacuum pressure becomes almost zero.

In the case when a ventilative or leaky workpiece should be adsorbed, take note that vacuum pressure will not rise.

Body Ported Type: ZH05D^SA-□-□-□ to ZH20D^SA-□-□-□

One-touch connections

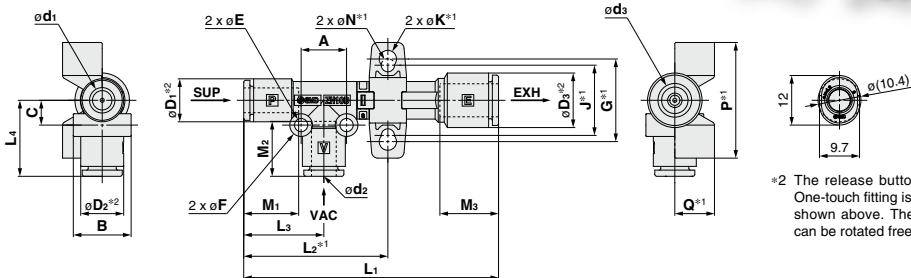

*2 The release button of ø6 One-touch fitting is oval as shown above. The button can be rotated freely.

All Ports: One-touch Fitting

	Model	D ₁	D ₂	D ₃	d ₁	d ₂	d ₃	M ₁	M ₂	M ₃	L ₁	L ₂ ^{*1}	L ₃	L ₄	A	B	C	E	F	G ^{*1}	J ^{*1}	K ^{*1}	N ^{*1}	P ^{*1}	Q ^{*1}		
Metric	ZH05D□A-06-06-06										51.8																
	ZH07D□A-06-06-06	10.4	10.4	10.4	6	6	6	13.3	13.3	13.3	55	34.9	19.4	18.4	11	14	6	3.2	5.5	20	17		4.2	3.2	28	9.6	
	ZH10D□A-06-06-08			13.2			8			14.2	61.7																
	ZH13D□A-08-10-10	13.2	15.9	15.9	8	10	10	14.2	15.6	15.6		71.8	43.9	22.4	24.4	17	20	9		7.8	27	22		4.2	3.2	12	
	ZH15D□A-08-10-10										83.6	51.4															
	ZH20D□A-10-12-12	15.9	18.5	18.5	10	12	12	15.6	17	17		105.7	60.9	28.4	26.4	22	22	10		8							
Inch	ZH05D□A-07-07-07										51.8																
	ZH07D□A-07-07-07	11.15	11.15	11.15	1/4"	1/4"	1/4"	13.3	13.3	13.3	55	34.9	19.4	18.4	11	14	6	3.2	5.5	20	17		4.2	3.2	28	9.6	
	ZH10D□A-07-07-09			13.2			5/16"			14.2	61.7																
	ZH13D□A-09-11-11	13.2	15.45	15.45	5/16"	3/8"	3/8"	14.2	15.6	15.6		71.8	43.9	22.4	24.4	17	20	9		7.8	27	22		4.2	3.2	12	
	ZH15D□A-09-11-11										83.6	51.4															
	ZH20D□A-11-13-13	15.45	19.3	19.3	3/8"	1/2"	1/2"	15.6	17	17		105.7	60.9	28.4	26.4	22	22	10		8							

*1 Dimensions when the standard bracket is mounted

Body Ported Type: ZH¹⁸D^SA-□-□-□

Standard bracket

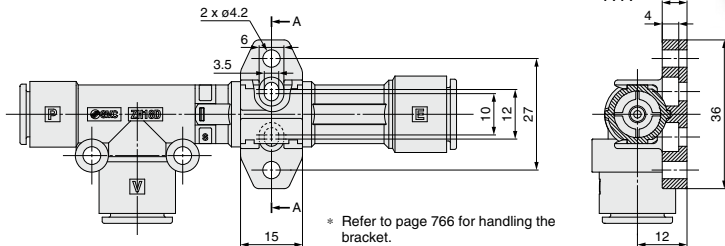

Silencer

ZH05 to 15D□A

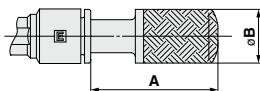

Model	A	øB
ZH05D□A-□-□-06/07	23.2	11
ZH07D□A-□-□-06/07		
ZH10D□A-□-□-08/09	30.8	13
ZH13D□A-□-□-10/11		
ZH15D□A-□-□-10/11	41.9	16.5

ZH18/20D□A-□-□-12

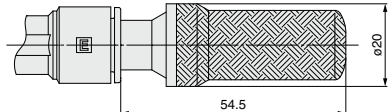

* Directly mounted silencer not available for 1/2" EXH port of ZH18/20D□A
* The standard bracket and silencer are not assembled with the product but shipped together.

Body Ported Type: ZH05D^SA-□-□-□ to ZH20D^SA-□-□-□

One-touch and screw-in connections

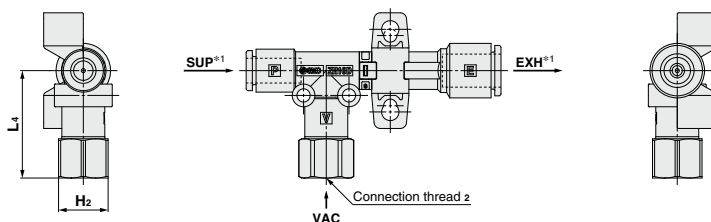

V Port: Screw-in P/E Port: One-touch Fitting

	Model	H ₂	L ₄	Connection thread 2
Metric	ZH05D□A-06-01-06	12	26	Rc1/8
	ZH07D□A-06-01-06			
	ZH10D□A-06-01-08	17	36.3	Rc1/4
	ZH13D□A-08-02-10			
	ZH15D□A-08-03-10			
	ZH18D□A-10-03-12	19	39.1	Rc3/8
	ZH20D□A-10-04-12	24	44.1	Rc1/2
	ZH05D□A-06-F01-06	12	27	G1/8
	ZH07D□A-06-F01-06			
	ZH10D□A-06-F01-08	17	37.5	G1/4
	ZH13D□A-08-F02-10			
	ZH15D□A-08-F03-10			
ZH18D□A-10-F03-12	19	40.5	G3/8	
ZH20D□A-10-F04-12	24	46.1	G1/2	
Inch	ZH05D□A-07-N01-07	12.7	26	NPT1/8
	ZH07D□A-07-N01-07			
	ZH10D□A-07-N01-09	17.46	36.3	NPT1/4
	ZH13D□A-09-N02-11			
	ZH15D□A-09-N03-11			
	ZH18D□A-11-N03-13	22.23	39	NPT3/8
ZH20D□A-11-N04-13	23.81	44.1	NPT1/2	

*1 Refer to page 755 for the dimensions of the SUP/EXH port one-touch connections.



Body Ported Type: ZH05D_LA-□-□-□ to ZH20D_LA-□-□-□

Screw-in connections

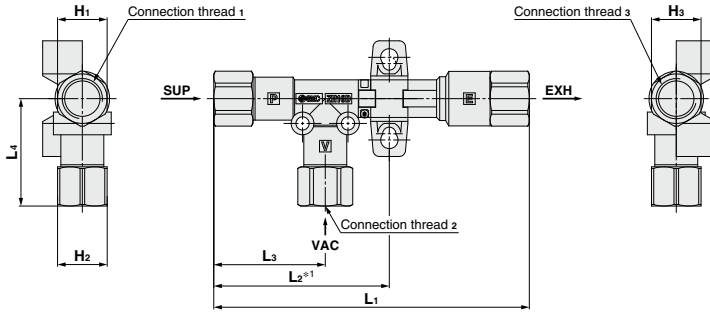

All Ports: Screw-in

Model		H ₁	H ₂	H ₃	L ₁	L ₂ *1	L ₃	L ₄	Connection thread 1	Connection thread 2	Connection thread 3	
Metric	ZH05D□A-01-01-01	12	12	12	67	42.5	27	26	Rc1/8	Rc1/8	Rc1/8	
	ZH07D□A-01-01-01				70.2							
	ZH10D□A-01-01-01				76.4							
	ZH13D□A-01-02-02	17	17	17	90.8	51	29.5	36.3	Rc1/4	Rc1/4	Rc1/4	
	ZH15D□A-02-03-03	19	19	19	108.2	63.3	34.3	37.1		Rc3/8	Rc3/8	Rc3/8
	ZH18D□A-03-03-03				131.1	73.6	41.1	39.1				
	ZH20D□A-03-04-04	19	24	24	142.6	74.9	41.1	44.1	Rc3/8	Rc1/2	Rc1/2	
	ZH05D□A-F01-F01-F01	12	12	12	69	43.5	28	27	G1/8	G1/8	G1/8	
	ZH07D□A-F01-F01-F01				72.2							
	ZH10D□A-F01-F01-F01				78.4							
	ZH13D□A-F01-F02-F02	17	17	17	93	52	30.5	37.5	G1/4	G1/4	G1/4	
	ZH15D□A-F02-F03-F03	19	19	19	112.1	65.3	36.3	39		G3/8	G3/8	G3/8
ZH18D□A-F03-F03-F03	134.4				75.5	43	40.5					
ZH20D□A-F03-F04-F04	19	24	24	146.5	76.8	41.1	46.1	G3/8	G1/2	G1/2		
Inch	ZH05D□A-N01-N01-N01	12.7	12.7	12.7	67	42.5	27	26	NPT1/8	NPT1/8	NPT1/8	
	ZH07D□A-N01-N01-N01				70.2							
	ZH10D□A-N01-N01-N01				76.4							
	ZH13D□A-N01-N02-N02	17.46	17.46	17.46	90.8	51	29.5	36.3	NPT1/4	NPT1/4	NPT1/4	
	ZH15D□A-N02-N03-N03	22.23	22.23	22.23	108.2	63.3	34.3	37.1		NPT3/8	NPT3/8	NPT3/8
	ZH18D□A-N03-N03-N03				131	73.6	41.1	39				
	ZH20D□A-N03-N04-N04	22.23	23.81	23.81	142.6	74.9	41.1	44.1	NPT3/8	NPT1/2	NPT1/2	

*1 Dimensions when the standard bracket is mounted

ZH Series

Body Ported Type: ZH05D^SL_A-□-□-□ to ZH20D^SL_A-□-□-□

L-bracket (Bracket on a single side)*1

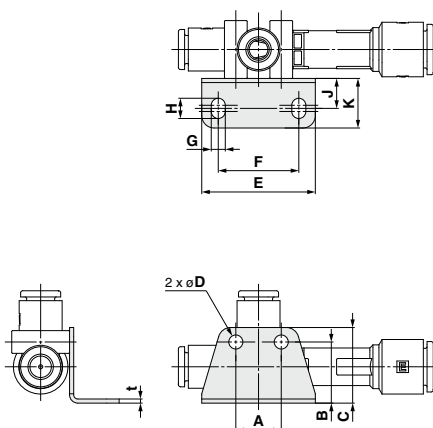

*1 Long clamping screw set for 1 station required for assembly needs to be ordered separately. Refer to page 751.

L-bracket (Brackets on both sides)*2

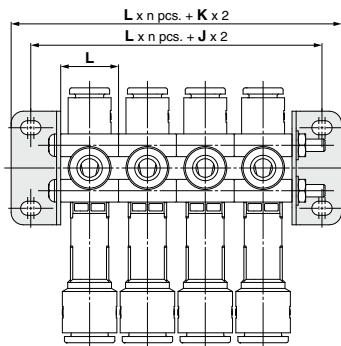

*2 Long clamping screw set which is required for assembly needs to be ordered separately. Refer to page 751.

* ZH15D□A-□-□-□-□-□
 ZH18D□A-□-□-□-□-□
 ZH20D□A-□-□-□-□-□
 ZH20D□A-□-□-□-□-□
 ZH20D□A-□-□-□-□-□

The above shown products cannot be mounted closely together, as width across flats of the screw-in connection will interfere with each other.

L-Bracket (Brackets on Both Sides)

Part no.	Applicable model	A	B	C	D	E	F	G	H	J	K	L	t
AS-10L	ZH05/07/10D□A	11	14.8	18.3	3.4	27.5	19.5	3.4	4.9	7.3	12	14	1
AS-25L	ZH13/15D□A	17	19.6	24.6	4.5	38	28	4.5	6.5	9.5	15.5	20	1.2
AS-30L	ZH18/20D□A	22	24.8	29.8		43	33					22	1.4

Body Ported Type: ZH05D^SL_A-□-□-□ to ZH20D^SL_A-□-□-□

DIN rail mounting bracket (Bracket on a single side)*1

ZH05 to 10D□A

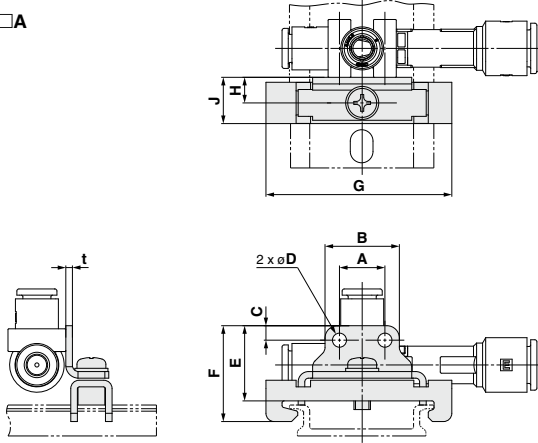

ZH13 to 20D□A

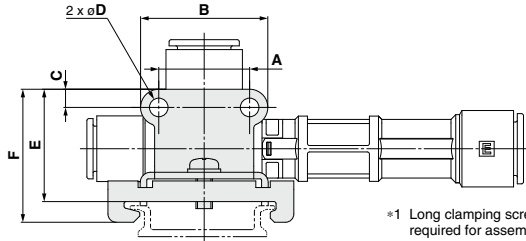

*1 Long clamping screw set for 1 station required for assembly needs to be ordered separately. Refer to page 751.

DIN rail mounting bracket (Brackets on both sides)*2

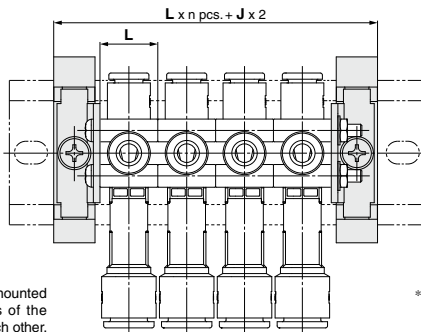

*2 Long clamping screw set which is required for assembly needs to be ordered separately. Refer to page 751.

* ZH15D□A-□-□-□-□
ZH18D□A-□-□-□-□
ZH20D□A-□-□-□-□
ZH20D□A-□-□-□-□
ZH20D□A-□-□-□-□

The above shown products cannot be mounted closely together, as width across flats of the screw-in connection will interfere with each other.

DIN Rail Mounting Bracket (Brackets on Both Sides)

Part no.	Applicable model	A	B	C	D	E	F	G	H	J	L	t
AS-10D	ZH05/07/10D□A	11	18	3.5	3.4	18.2	23.2	45	6.2	11.2	14	1.6
AS-25D	ZH13/15D□A	17	25.8	4.4	4.5	22	27				20	
AS-30D	ZH18/20D□A	22	30.8			27.2	32.2				22	

ZH Series

Box Type: ZH05B^SA-□-□ to ZH20B^SA-□-□

One-touch connections
ZH05 to 13B□A

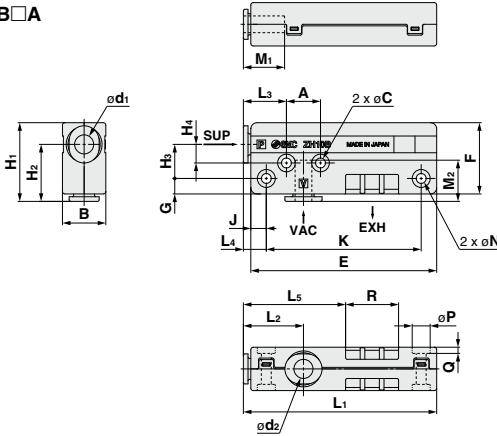

ZH15 to 20B□A

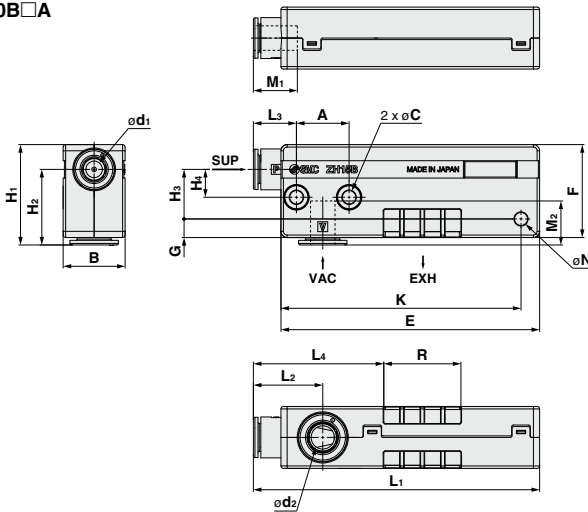
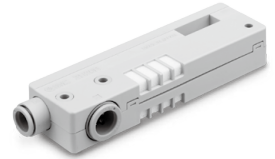

All Ports: One-touch Fitting

Model		d ₁	d ₂	M ₁	M ₂	L ₁	L ₂	L ₃	L ₄	L ₅	H ₁	H ₂	H ₃	H ₄	A	B	C	E	F	G	J	K	N	P	Q	R	
Metric	ZH05B□A-06-06					59.4				33.1								57	23	5	5	47	3.2	5.8	2	15	
	ZH07B□A-06-06	6	6	13.3	13.3	62.4	19.4	13.9	7.4	33	25.4	18.4	11	6	11	14	3.2	60				50				17.1	
	ZH10B□A-06-06																										
	ZH13B□A-08-10	8	10	14.2	15.6	77.4	22.4		9.4	37.6	32.4	24.4	16	9	17	20	4.3	75	30	6	7	61	4.2	7.5	3	24.9	
	ZH15B□A-08-10	8	10	14.2	15.6	92.4	22.4	13.9	42.1		32.4	24.4	16	9	17	20		83.5	30	6		77.5				24.9	
	ZH18B□A-10-12	10	12	15.6	17	132.4	28.4	17.4	50.1		37.4	26.4	17	10	22	22		4.3	121.7	35	7		114.7	4.2			26.9
Inch	ZH05B□A-07-07					59.4				33.1								57	23	5	5	47	3.2	5.8	2	15	
	ZH07B□A-07-07	1/4"	1/4"	13.3	13.3	62.4	19.4	13.9	7.4	33	25.4	18.4	11	6	11	14	3.2	60				50				17.1	
	ZH10B□A-07-07																										
	ZH13B□A-09-11	5/16"	3/8"	14.2	15.6	77.4	22.4		9.4	37.6	32.4	24.4	16	9	17	20	4.3	75	30	6	7	61	4.2	7.5	3	24.9	
	ZH15B□A-09-11	5/16"	3/8"	14.2	15.6	92.4	22.4	13.9	42.1		32.4	24.4	16	9	17	20		83.5	30	6		77.5				24.9	
	ZH18B□A-11-13	3/8"	1/2"	15.6	17	132.4	28.4	17.4	50.1		37.4	26.4	17	10	22	22		4.3	121.7	35	7		114.7	4.2			26.9
ZH20B□A-11-13																											

Box Type: ZH05B^SA-□-□ to ZH20B^SA-□-□

One-touch and screw-in connections
ZH05 to 13B□A

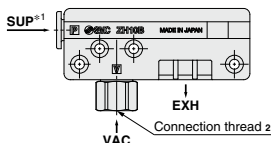
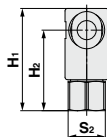

ZH15 to 20B□A

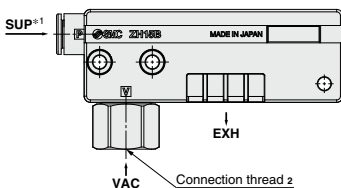
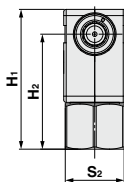

One-touch and Screw-in Connections

	Model	S ₂	H ₁	H ₂	Connection thread 2
Metric	ZH05B□A-06-01	12	33	26	Rc1/8
	ZH07B□A-06-01				
	ZH10B□A-06-01				
	ZH13B□A-08-02	17	44.3	36.3	Rc1/4
	ZH05B□A-06-F01	12	34	27	G1/8
	ZH07B□A-06-F01				
	ZH10B□A-06-F01				
	ZH13B□A-08-F02	17	45.5	37.5	G1/4
	ZH15B□A-08-03	19	45.1	37.1	Rc3/8
	ZH18B□A-10-03				
	ZH20B□A-10-04	24	55.1	44.1	Rc1/2
	ZH15B□A-08-F03	19	47	39	G3/8
	ZH18B□A-10-F03				
	ZH20B□A-10-F04	24	57.1	46.1	G1/2
Inch	ZH05B□A-07-N01	12.7	33	26	NPT1/8
	ZH07B□A-07-N01				
	ZH10B□A-07-N01				
	ZH13B□A-09-N02	17.46	44.3	36.3	NPT1/4
	ZH15B□A-09-N03	22.23	45.1	37.1	NPT3/8
	ZH18B□A-11-N03				
ZH20B□A-11-N04	23.81	55.1	44.1	NPT1/2	

*1 Refer to page 760 for the dimensions of the SUP port one-touch connection.

ZH Series

Box Type: ZH05B^SA-□-□ to ZH20B^SA-□-□

Screw-in connections
ZH05 to 13B□A

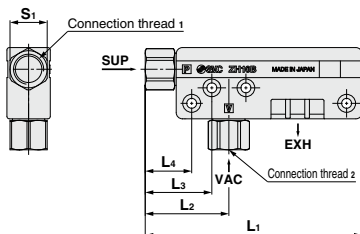

ZH15 to 20B□A

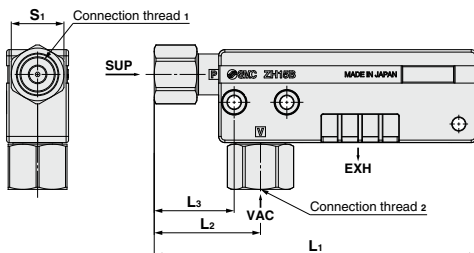

Screw-in Connections

Model		S1	L1	L2	L3	L4	Connection thread 1	Connection thread 2
Metric	ZH05B□A-01-01	12	67	27	21.5	15	Rc1/8	Rc1/8
	ZH07B□A-01-01		70					
	ZH10B□A-01-01		84.5	29.5	21			
	ZH13B□A-01-02							
	ZH05B□A-F01-F01	12	68	28	22.5	16	G1/8	G1/8
	ZH07B□A-F01-F01		71					
	ZH10B□A-F01-F01		85.5	30.5	22			
	ZH13B□A-F01-F02							
	ZH15B□A-02-03	17	104.3	34.3	25.8	—	Rc1/4	Rc3/8
	ZH18B□A-03-03	19	145.1	41.1	30.1		Rc3/8	Rc1/2
ZH20B□A-03-04								
ZH15B□A-F02-F03	17	106.3	36.3	27.8	—	G1/4	G3/8	
ZH18B□A-F03-F03	19	147	43	32		G3/8	G1/2	
ZH20B□A-F03-F04								
Inch	ZH05B□A-N01-N01	12.7	67	27	21.5	15	NPT1/8	NPT1/8
	ZH07B□A-N01-N01		70					
	ZH10B□A-N01-N01		84.5	29.5	21			
	ZH13B□A-N01-N02							
	ZH15B□A-N02-N03	17.46	104.3	34.3	25.8	—	NPT3/8	NPT3/8
	ZH18B□A-N03-N03	22.23	145.1	41.1	30.1		NPT3/8	NPT1/2
	ZH20B□A-N03-N04							

Box Type: ZH05B^SA-□-□ to ZH20B^SA-□-□

L-bracket (Bracket on a single side)*1

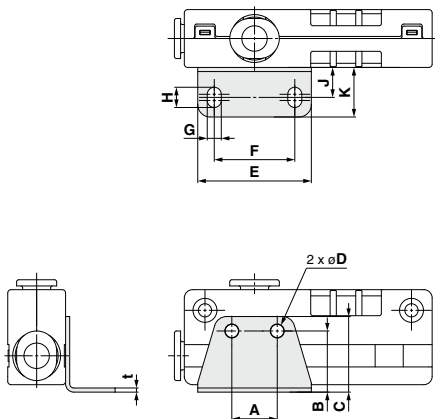

*1 Long clamping screw set for 1 station required for assembly needs to be ordered separately. Refer to page 751.

L-bracket (Brackets on both sides)*2

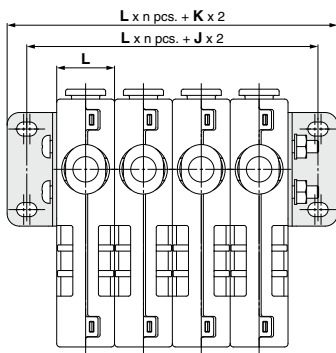

*2 Long clamping screw set which is required for assembly needs to be ordered separately. Refer to page 751.

- * ZH15B□A-□-□N03
- ZH18B□A-□-□N03
- ZH20B□A-□-□04
- ZH20B□A-□-□F04
- ZH20B□A-□-□N04

The above shown products cannot be mounted closely together, as width across flats of the screw-in connection will interfere with each other.

L-Bracket (Brackets on Both Sides)

Part no.	Applicable model	A	B	C	D	E	F	G	H	J	K	L	t
AS-10L	ZH05/07/10B□A	11	14.8	18.3	3.4	27.5	19.5	3.4	4.9	7.3	12	14	1
AS-25L	ZH13/15B□A	17	19.6	24.6	4.5	38	28	4.5	6.5	9.5	15.5	20	1.2
AS-30L	ZH18/20B□A	22	24.8	29.8		43	33					22	1.4

ZH Series

Box Type: ZH05B^SA-□-□ to ZH13B^SA-□-□

DIN rail mounting bracket (Bracket on a single side)*1

ZH05 to 10B□A

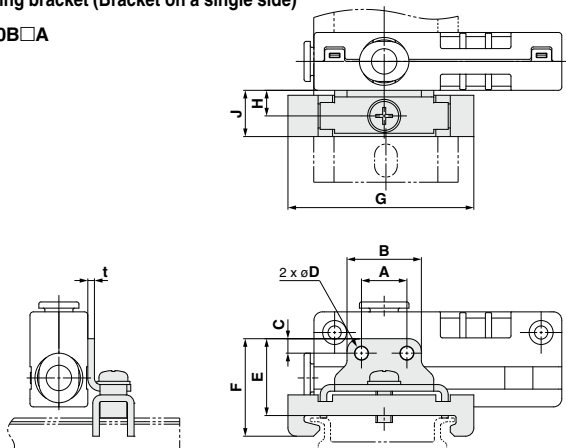

ZH13 to 20B□A

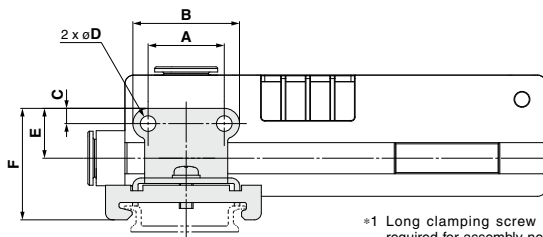

*1 Long clamping screw set for 1 station required for assembly needs to be ordered separately. Refer to page 751.

DIN rail mounting bracket (Brackets on both sides)*2

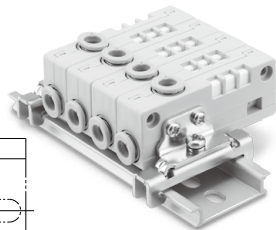
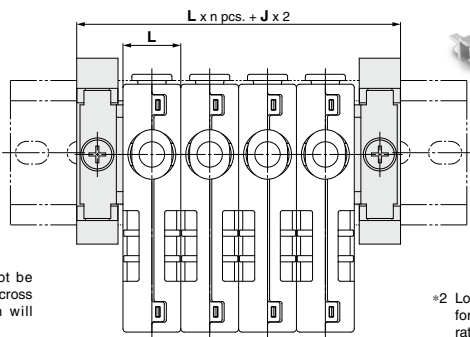

*2 Long clamping screw set which is required for assembly needs to be ordered separately. Refer to page 751.

* ZH15B□A-□-□N03
ZH18B□A-□-□N03
ZH20B□A-□-□04
ZH20B□A-□-□F04
ZH20B□A-□-□N04

The above shown products cannot be mounted closely together, as width across flats of the screw-in connection will interfere with each other.

DIN Rail Mounting Bracket (Brackets on Both Sides)

Part no.	Applicable model	A	B	C	D	E	F	G	H	J	L	t
AS-10D	ZH05/07/10B□A	11	18	3.5	3.4	18.2	23.2	45	6.2	11.2	14	1.6
AS-25D	ZH13/15B□A	17	25.8	4.4	4.5	22	27				20	
AS-30D	ZH18/20B□A	22	30.8		27.2	32.2	22					

ZH Series Circuit Examples

⚠ Caution

Handling of Circuits

Select the related air preparation equipment with appropriate size in reference to the circuit example below.

Ex. 1 Supply valve (2-port valve) + Suction filter

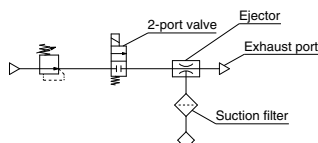

2-port valve is used to generate and stop the vacuum. Vacuum is released to the atmosphere. A suction filter is installed to protect the ejector.

Ex. 2 Supply valve (3-port valve) + Variable throttle + Suction filter

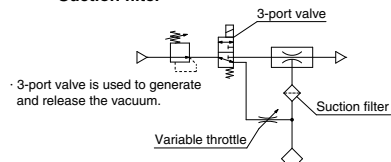

3-port valve is used to generate and release the vacuum.

3-port valve is used to generate and stop the vacuum (vacuum release is performed simultaneously). Variable throttle is installed for break flow adjustment. A suction filter is protecting the ejector.

* It is not possible to bring this circuit to a complete stop.

A valve must be added on the release side circuit in order to perform a complete stop.

Ex. 3 Supply valve (3-port valve) + Variable throttle + Suction filter + Silencer

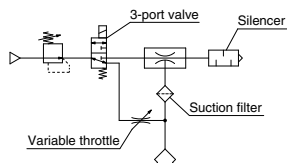

Power failure is prevented by changing the valve piping of Ex. 2 and applying vacuum generation N.O. specification. Variable throttle and suction filters are installed. A silencer is mounted to the exhaust port (to reduce exhaust noise).

* It is not possible to bring this circuit to a complete stop.

A valve must be added on the release side circuit in order to perform a complete stop.

Ex. 4 Supply valve (2-port valve) + Release valve (2-port valve) + Variable throttle + Silencer + Suction filter + Pressure gauge

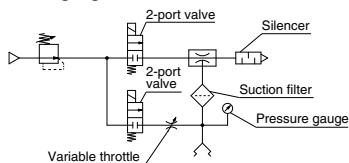

Vacuum generation and vacuum release are controlled by a supply valve and release valve. A pressure gauge is installed to visually check the vacuum pressure during adsorption. The suction filter should be mounted to the location where the collected dust should not flow back due to the release of air. (When using the 3-port valve, seal the R-port of the release valve.)

Ex. 5 Supply/Release valve (5-port valve with 3-position) + Variable throttle

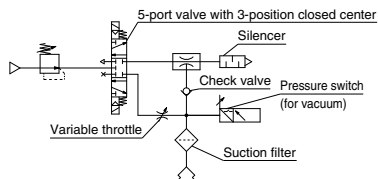

5-port valve with 3-position closed center is used to control the vacuum generation and release. A check valve is installed to the vacuum port to prevent vacuum pressure from being reduced when the supply valve is OFF*1. A pressure switch is installed in the vacuum circuit to detect pressure. A suction filter should be mounted to the position where the duct collected by release air can be flushed by released air.

*1 The vacuum may leak depending on the check valve used. If a breathable workpiece is used, vacuum pressure is reduced rapidly. Sufficient verification is required before use.



ZH Series Specific Product Precautions 1

Be sure to read this before handling the products. Refer to page 33 for safety instructions and pages 34 to 36 for vacuum equipment precautions.

Mounting

⚠ Caution

1. Load to the ejector body

As the body material is resin, do not apply any load to the port after mounting. Prevent operations which generate moment, as they may cause performance reduction or damage to the body.

2. Standard bracket

It is possible to mount and remove the standard bracket, which is included with this product (an option without a bracket can also be selected). Do not excessively pull on or bend the bracket as it may break. The appropriate tightening torques for the standard bracket, body mounting hole (Fig. 1), and cover mounting hole (Fig. 2) are shown below.

For M3: 0.315 ± 0.03 N·m For M4: 0.76 ± 0.08 N·m

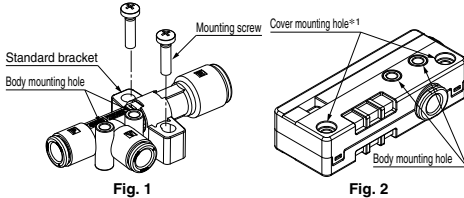

Fig. 1

Fig. 2

*1 1 location for the ZH15 to 20B

● Mounting of the standard bracket (ZH05 to 15D□A) and adjustment of the vacuum (V) port

- 1) Align the recess of the standard bracket and the protrusion of the adapter. Push the bracket from the top onto the adapter (Fig. 3).
- 2) Adjust the adapter to rotate the vacuum (V) port (Fig. 4).

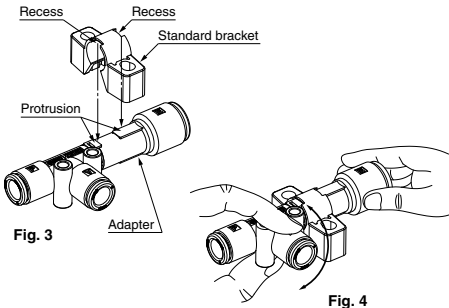

Fig. 3

Fig. 4

- 3) When mounting the product with the standard bracket, tighten the screw while holding both sides of the bracket. If the fit of the bracket is loose, the ejector may move after tightening the screws. (Fig. 5)

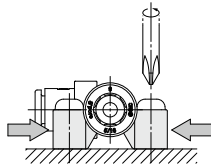

Fig. 5

● Mounting of the standard bracket (ZH18/20D□A) and adjustment of the vacuum (V) port

- 1) The standard bracket for the ZH18/20D□A can be mounted by using either mounting hole 1 or 2 (Fig. 6).
- 2) When mounting the product through mounting hole 1, mount the bracket to the installation surface first (Fig. 6).
- 3) To mount the product to the bracket, push it down with the adapter's narrow rib and E mark facing upward and the wider rib to the side (Fig. 7). Hold the adapter when rotating the vacuum (V) port for adjustment.
- 4) To remove the body from the bracket, unclip the fingers (2 pcs.) on one side and pull the ejector upward while rotating the adapter. If the ejector is pulled upward without first unclipping the fingers, it may damage the bracket (Fig. 8, 9). If an increased holding force is required, please contact your SMC sales representative.

Bracket for ZH18/20D□A

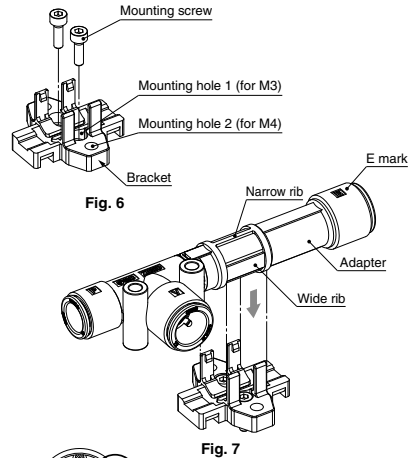

Fig. 6

Fig. 7

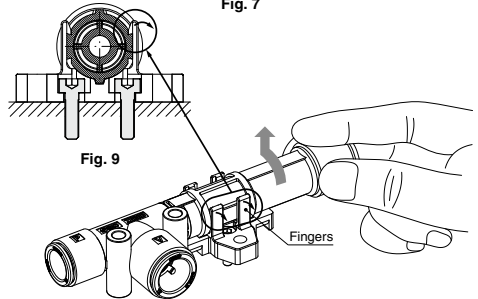

Fig. 9

Fig. 8



ZH Series Specific Product Precautions 2

Be sure to read this before handling the products. Refer to page 33 for safety instructions and pages 34 to 36 for vacuum equipment precautions.

Mounting

⚠ Caution

3. Precautions for mounting with the body mounting holes

If the models listed below are to be mounted on a plane surface through the body mounting holes, the outside diameter of the screw-in stud will interfere with the mounting surface. Therefore, use a spacer with a thickness of "t" dimension or more (Fig. 9).

Applicable model	t*1
ZH15D□A-□-N03-□ ZH15B□A-□-N03	2
ZH18D□A-□-N03-□ ZH18B□A-□-N03	1
ZH20D□A-□-04-□ ZH20D□A-□-F04-□ ZH20D□A-□-N04-□	
ZH20B□A-□-04 ZH20B□A-□-F04 ZH20B□A-□-N04	

*1 When the body mounting hole surface and the width across flats of the screw-in stud are parallel

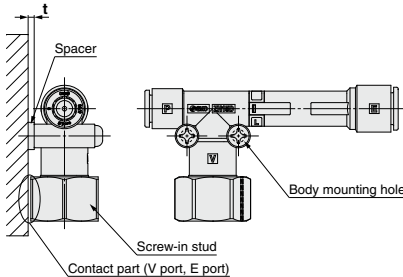

Fig. 9

4. Exhaust port

When mounting the box type product, be sure to allow release from at least 2 of the 4 exhaust directions shown in Fig. 10. If 3 or more directions are covered, the vacuum performance of the ejector will be reduced due to exhaust air back pressure.

● Precautions for mounting the box type

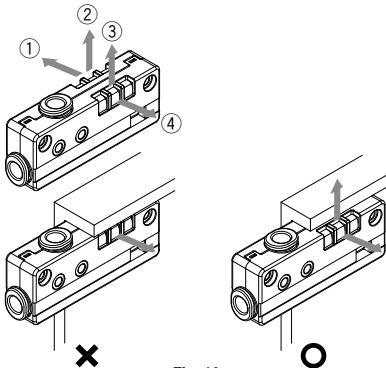

Fig. 10

Piping

⚠ Caution

1. Piping diameter

The piping diameter for each port should be the standard size for One-touch fittings. If the piping diameter is reduced, it may lead to the insufficient flow of supply air, the reduction of suction flow, and a reduction in the vacuum pressure.

2. Exhaust port piping

If there is any piping or a silencer connected to the exhaust port, keep the back pressure at 5 kPa or less. Increased back pressure may lead to the reduction of suction flow and delays in the transport cycle time. If a silencer is connected, the specified vacuum performance is reduced by 10% or less.

3. One-touch fittings

Refer to the "Fittings and Tubing Precautions" on the SMC website for handling One-touch fittings.

4. Piping to the female thread type

When mounting a fitting to the screw-in stud (female thread), hold the width across flats with an appropriate size wrench. If the load is applied to the resin body directly, it may damage the body.

Model Selection

⚠ Caution

1. Supply valve

Select a supply valve which can supply a sufficient flow rate that takes the ejector air consumption into account. If the flow rate of the supply valve is insufficient, it may lead to vacuum failure. The selected supply valve should have a C factor of at least the value shown in the table below.

Minimum Supply Valve C Factor

Model	C [dm ³ /(s·bar)]
ZH05□□A	0.12
ZH07□□A	0.23
ZH10□□A	0.47
ZH13□□A	0.80
ZH15□□A	1.06
ZH18□□A	1.53
ZH20□□A	1.88

2. Mounting of air equipment

If particles are sucked through the vacuum (V) port during workpiece adsorption, the vacuum performance might be reduced due to the adhesion of particles in the air passage of the product or clogging of the exhaust passage (silencer). The installation of an air suction filter (ZFA, ZFB, or ZFC series) in the middle of the piping on the vacuum side is recommended to prevent performance reduction. If air containing moisture is sucked, vacuum performance might also be reduced for the same reason. In this case, install a drain separator for vacuum (AMJ series).



ZH Series

Specific Product Precautions 3

Be sure to read this before handling the products. Refer to page 33 for safety instructions and pages 34 to 36 for vacuum equipment precautions.

Air Supply

⚠ Caution

1. Quality of supply air

The recommendation for cleanliness of the compressed air supplied to the product is as specified in "System No. C [Dry air]" of the "Model Selection Guide of Air Preparation Equipment" on the SMC website. This describes the impurity content in the compressed air based on the grade of compressed air quality 2:4:3, 2:5:3 and 2:6:3 of ISO 8573-1:2010 (JIS B 8392-1:2012)

If impurities enter the product, vacuum performance might be reduced due to the deterioration of the air passage or clogging of the exhaust system.

Ejector Characteristics

⚠ Caution

1. Intermittent noise during vacuum generation

When the ejector standard supply pressure is close to the pressure that generates peak vacuum pressure, the vacuum pressure may become unstable due to fluid vibration. If there is any operation failure or the intermittent noise needs to be reduced, increase or decrease the supply pressure. Avoid the supply pressure range where the vacuum pressure becomes unstable.

2. Temperature reduction and vapor condensation during vacuum generation

When the ejector generates vacuum, compressed air expands adiabatically after passing through the nozzle. This reduces the temperature around the nozzle, so condensation might be generated on the product surface (the condensation dew point may vary depending on the temperature and relative humidity of the operating environment).

When Operating the Ejector

⚠ Caution

1. Exhaust air

If solid substances are sucked in through the vacuum (V) port, they will be discharged from the exhaust port at a high speed if the exhaust (EXH) port is opened. Therefore, do not look into the exhaust port or direct the exhaust port toward a person when the ejector is operating.

2. Exhaust noise

Models with a large nozzle diameter generate a large exhaust noise if the exhaust (EXH) port is opened. Install piping or a silencer to the exhaust port to reduce the exhaust noise.

Identification

⚠ Caution

1. The appearance of the screw-in connection differs depending on the thread type. (Fig. 11)

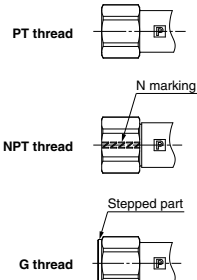

Fig. 11

2. For the box type, a different identification mark symbol is used according to the vacuum pressure reached (type S or type L). (Fig. 12)

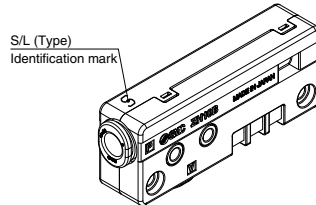

Fig. 12