



ORIGINAL INSTRUCTIONS

Instruction Manual

Thermo-chiller

HRLE050-A/W-20 Series

HRLE090-A/W-20/40 Series

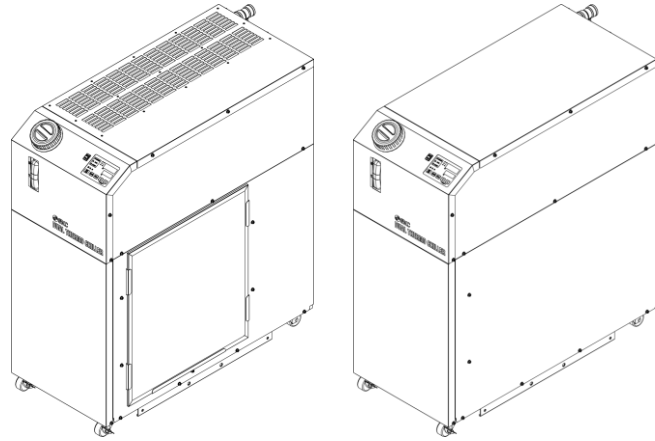

2 Specifications

2.1 HRLE050-A/W-20 Specifications

Model	HRLE050-A-20	HRLE050-W-20
Cooling Method	Air-cooled	Water-cooled
Refrigerant	R410A (HFC)	
Quantity of refrigerant	kg	1.32
Temperature control method	PID Method	
Ambient temperature	°C	
Circulating fluid (note1)	Tap water, Deionized (pure) water	
Set temperature range	°C	
Cooling capacity (Total of CH1 and 2) 50/60Hz (note2)	kW	
Heating capacity (Total of CH1 and 2) 50/60Hz (note3)	kW	
Temperature stability (note4)	°C	
Pump capacity	L/min	
Rated flow 50/60Hz (note5)	L/min	
Maximum flow rate 50/60Hz	L/min	
Maximum pump head	m	
Minimum operating flow 50/60Hz (note6)	L/min	
Tank capacity (Total CH1 and 2)	L	
Fluid outlet, Fluid return port size	CH1: Rc1/2, CH2: Rc1/2	
Drain port size	Rc1/4	
Fluid contact material	Stainless steel, Copper (Heat exchanger brazing), Bronze, Carbon, FKM, PP, PE, POM, PVC, PA, EPDM	
Fluid contact material (-M)	Stainless steel (Heat exchanger brazing), SIC, Carbon, FKM, PP, PE, POM, PVC, PA, EPDM, PTFE	
Temperature range	°C	
Pressure range	MPa	
Required flow 50/60Hz (note8)	L/min	
Facility water pressure differential	MPa	
Facility water inlet/outlet	Rc1/2	
Fluid contact material	Stainless steel, copper (heat exchanger brazing), brass, carbon, PTFE, NBR, EPDM	

The intended use of this product uses a built-in pump to circulate a liquid such as water, adjusted to a constant temperature by the refrigeration circuit. This circulating liquid cools parts of customer's machine that generates heat.

1 Safety Instructions

These safety instructions are intended to prevent hazardous situations and/or equipment damage. These instructions indicate the level of potential hazard with the labels of "Caution," "Warning," or "Danger." They are all important notes for safety and must be followed in addition to International Standards (ISO/IEC) <sup>1)</sup>, and other safety regulations.

- <sup>1)</sup> ISO 4414: Pneumatic fluid power - General rules relating to systems.
- ISO 4413: Hydraulic fluid power - General rules relating to systems.
- IEC 60204-1: Safety of machinery - Electrical equipment of machines. (Part 1: General requirements)
- ISO 10218-1: Robots and robotic devices - Safety requirements for industrial robots - Part 1: Robots.

- Refer to Product Catalogue, Operation Manual and Handling Precautions for SMC Products for additional information.
- Keep this manual in a safe place for future reference.

<b>Caution</b>	Caution indicates a hazard with a low level of risk which, if not avoided, could result in minor or moderate injury.
<b>Warning</b>	Warning indicates a hazard with a medium level of risk which, if not avoided, could result in death or serious injury.
<b>Danger</b>	Danger indicates a hazard with a high level of risk which, if not avoided, will result in death or serious injury.

**Warning**

- Always ensure compliance with relevant safety laws and standards.
- All work must be carried out in a safe manner by a qualified person in compliance with applicable national regulations.

Model	HRLE050-A-20	HRLE050-W-20
Power supply	Single-phase 200 to 230 VAC (50/60Hz) Allowable voltage range ±% (No continuous voltage fluctuation)	
Earth leakage breaker	Rated current	A
	Sensitivity of leak current	mA
Rated operating current 50/60Hz	A	12.1/14.4
Rated power consumption 50/60Hz	kW (kVA)	2.4/2.9 (2.2/2.8)
Communication function	Contact input/output, Serial RS-485	
Noise level	dB(A)	
Accessories (note7)	Operation manual (installation/operation) 2pcs. (English 1pc./Japanese 1pc.), Anchor bolt brackets 2pcs. (Including four M8 bolts), Cable accessory 1pc. (For communication cable)	
Weight	kg	114

- (Note1) Use the water listed below.  
Tap water: Water Standards of the Japan Refrigeration and Air Conditioning Industry Association (JRA GL-02-1994), Deionized(pure) water: Electric conductance 0.4 μs/cm or more (Electrical resistivity 2.5MΩ·cm or less)
- (Note2) (1) Ambient temp./Facility water temp.: 25°C, (2) Circulating fluid: Tap water, (3) Circulating fluid temp.: CH1: 20°C/CH2: 25°C, (4) Circulating fluid flow rate: rated flow, (5) Power supply: 200 VAC.
- (Note3) (1) Ambient temp./Facility water temp.: 25°C, (2) Circulating fluid: Tap water, (3) Circulating fluid flow rate: rated flow, (4) Power supply: 200 VAC.
- (Note4) (1) Ambient temp./Facility water temp.: 25°C, (2) Circulating fluid: Tap water, (3) Circulating fluid temp.: CH1: 20°C/CH2: 25°C, (4) Circulating fluid flow rate: rated flow, (5) Power supply: 200 VAC, (6) Piping length: Shortest, (7) Rated cooling load is applied.
- (Note5) When circulating fluid outlet port pressure = 0.21/0.29MPa (50/60Hz).
- (Note6) Fluid flow rate to maintain the cooling capacity and to keep the circulating fluid discharge pressure to 0.5 MPa or less.  
If the actual flow rate is lower than this, install a bypass piping.
- (Note7) The anchor bolt fixing brackets (including four M8 bolts) are used for fixing to wooden skids when packaging the thermo-chiller. No anchor bolt is included.
- (Note8) The flow rate required when the load described in the cooling capacity is applied at a circulating fluid temperature of 20°C, circulating fluid rated flow rate, and facility water temperature of 25°C

2 Specifications (continued)

2.2 HRLE090-A/W-20/40 Specifications

Model	HRLE090-A-20	HRLE090-W-20	HRLE090-A-40	HRLE090-W-40
Cooling Method	Air-cooled	Water-cooled	Air-cooled	Water-cooled
Refrigerant	R410A (HFC)			
Quantity of refrigerant	kg	2	1.9	2
Temperature control method	PID Method			
Ambient temperature	°C			
Circulating fluid (note1)	Tap water, Deionized (pure) water			
Set temperature range	°C			
Cooling capacity (Total of CH1 and 2) 50/60Hz (note2)	kW			
Heating capacity (Total of CH1 and 2) 50/60Hz (note3)	kW			
Temperature stability (note4)	°C			
Pump capacity	L/min			
Rated flow 50/60Hz (note5)	L/min			
Maximum flow rate 50/60Hz	L/min			
Maximum pump head	m			
Minimum operating flow 50/60Hz (note6)	L/min			
Tank capacity (Total CH1 and 2)	L			
Fluid outlet, Fluid return port size	CH1: Rc1, CH2: Rc1/2			
Drain port size	Rc1/4			
Fluid contact material	Stainless steel, Copper (Heat exchanger brazing), Bronze, Carbon, FKM, PP, PE, POM, PVC, PA, EPDM			
Fluid contact material (-M)	Stainless steel (Heat exchanger brazing), SIC, Carbon, FKM, PP, PE, POM, PVC, PA, EPDM, PTFE			
Temperature range	°C			
Pressure range	MPa			
Required flow 50/60Hz	L/min			
Facility water pressure differential	MPa			
Facility water inlet/outlet	Rc1/2			
Fluid contact material	ONLY WATER COOLED: Stainless steel, copper (heat exchanger brazing), brass, carbon, PTFE, NBR, EPDM			

Model	HRLE090-A-20	HRLE090-W-20	HRLE090-A-40	HRLE090-W-40
Power supply	3-phase 200 VAC (50Hz) Allowable voltage range ±10% (No continuous voltage fluctuation)		3-phase 380 to 415 VAC (50/60Hz) Allowable voltage range ±10% (No continuous voltage fluctuation)	
Earth leakage breaker (note9)	Rated current	A	30	20
	Sensitivity of leak current	mA	30	30
Rated operating current 50/60Hz	A	14/17	13.5/14.4	6.8/8.2
Rated power consumption 50/60Hz	kW (kVA)	4.3/5.3 (4.9/5.8)	3.5/4.4 (4.7/5.0)	4.3/5.3 (4.9/5.8)
Communication function	Contact input/output, Serial RS-485			
Noise level	dB(A)			
Accessories (note7)	Operation manual (installation/operation) 2pcs. (English 1pc./Japanese 1pc.), Anchor bolt brackets 2pcs. (Including four M8 bolts), Cable accessory 1pc. (for communication cable)			
Weight	kg	140	134	140

- (Note1) Use the water listed below.  
Tap water: Water Standards of the Japan Refrigeration and Air Conditioning Industry Association (JRA GL-02-1994)  
Deionized(pure) water: Electric conductance 0.4 μs/cm or more (Electrical resistivity 2.5MΩ·cm or less)
- (Note2) (1) Ambient temp./Facility water temp.: 32°C, (2) Circulating fluid: Tap water, (3) Circulating fluid temp.: CH1: 20°C/CH2: 25°C, (4) Circulating fluid flow rate: rated flow, (5) Power supply: 200/400 VAC.
- (Note3) (1) Ambient temp./Facility water temp.: 32°C, (2) Circulating fluid: Tap water, (3) Circulating fluid flow rate: rated flow, (4) Power supply: 200/400 VAC.
- (Note4) (1) Ambient temp./Facility water temp.: 32°C, (2) Circulating fluid: Tap water, (3) Circulating fluid temp.: CH1: 20°C/CH2: 25°C, (4) Circulating fluid flow rate: rated flow, (5) Power supply: 200/400 VAC, (6) Piping length: Shortest, (7) Rated cooling load is applied.
- (Note5) When circulating fluid outlet port pressure = 0.5MPa.
- (Note6) Fluid flow rate to maintain the cooling capacity and to keep the circulating fluid discharge pressure to 0.5 MPa or less.  
If the actual flow rate is lower than this, install a bypass piping.
- (Note7) The anchor bolt fixing brackets (including four M8 bolts) are used for fixing to wooden skids when packaging the thermo-chiller. No anchor bolt is included.
- (Note8) For 400V version, to be prepared by the user.

2 Specifications (continued)

2.3 Product Serial Number Code

The production serial number code printed on the label indicates the month and year of production as per the following table:

Year	2022	2023	....	2027	2028	2029	....
Month	A	B	....	F	G	H	....
Jan	o	Ao	Bo	....	Fo	Go	Ho
Feb	p	AP	BP	....	FP	GP	HP
Mar	q	AQ	BQ	....	FQ	GQ	HQ
Apr	r	AR	BR	....	FR	GR	HR
May	s	AS	BS	....	FS	GS	HS
Jun	t	AT	BT	....	FT	GT	HT
Jul	u	AU	BU	....	FU	GU	HU
Aug	v	AV	BV	....	FV	GV	HV
Sep	w	AW	BW	....	FW	GW	HW
Oct	x	AX	BX	....	FX	GX	HX
Nov	y	Ay	By	....	Fy	Gy	Hy
Dec	z	AZ	BZ	....	FZ	GZ	HZ

3 How to Order

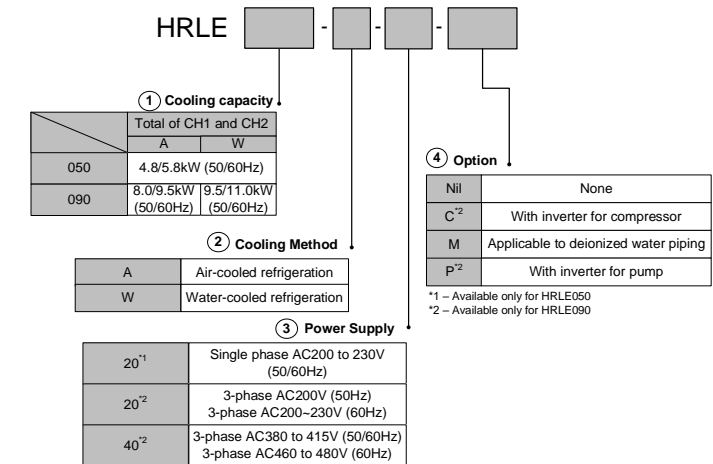

**Warning**

- Special products (-X) might have specifications different from those shown in this section. Contact SMC for specific drawings

4 Outline Dimensions

4.1 Dimensions of HRLE050-A-20 and HRLE090-A-20/40

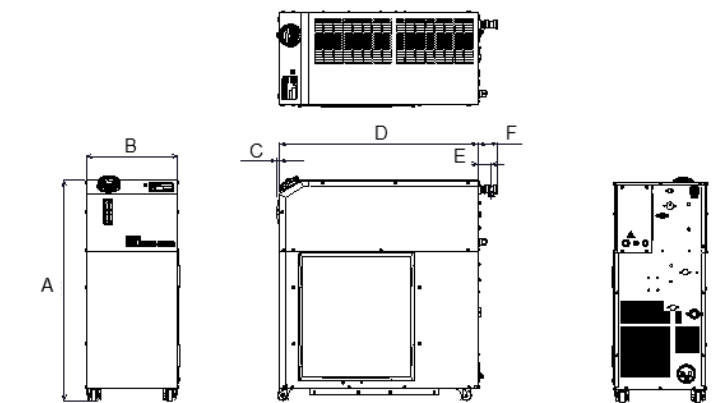

Dimension (mm)	HRLE050-A	HRLE090-A
A	1055	1055
B	445	445
C	(10)	(10)
D	965	965
E	(62)	(62)
F	(90)	(95)

#### 4 Outline Dimensions (continued)

##### 4.2 Dimensions of HRLE050-W-20 and HRLE090-W-20/40

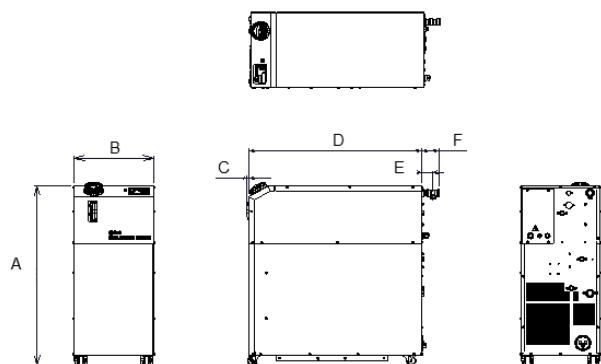

Dimension (mm)	HRLE050-W	HRLE090-W
A	1055	1055
B	445	445
C	(10)	(10)
D	965	965
E	(62)	(62)
F	(90)	(95)

#### 5 Names of Parts and Accessories

##### 5.1 Name of Each Part

Refer to Chapter 2 of operation manual.

##### 5.2 Accessories Table

1	Operation Manual	2 copy (English 1 pc. / Japanese 1 pc.)	
2	Cable accessory *Use for communication cable	1 pc.	
3	Anchor brackets *The anchor bolts are not attached.	2 pcs.	

##### 5.3 Function of Each Part

Name	Function
Power supply switch	Power ON / OFF of the product.
Operation display panel	Runs and stops the product and performs settings such as for the circulating fluid temperature.
Fluid level gauge	Indicates the circulating fluid level of the tank. Confirm the level is between "H" and "L".
Product Label	Shows the product information such as model number and serial number.
Circulating fluid outlet port	The circulating fluid is discharged from the outlet port.
Circulating fluid return port	The circulating fluid returns to the return port.
Drain port	This drain port is for draining the circulating fluid in the tank and pump.
Dust-proof filter	Inserted to prevent dust or contamination from getting directly on the air-cooled condensers. Clean the filter periodically.
Power cable entry	Insert the power cable into the power cable entry and connect it to the breaker.
Communication cable entry	Insert the communication cable into the communication cable entry and connect it to the communication terminal.
Communication terminal	
Facility water inlet port	Supply facility water to inlet port.
Facility water outlet port	Facility water out from outlet port and return to customer's facility water system.

##### 5.4 Operation Panel

The operation display panel on the front of the product controls the basic operation of the product.

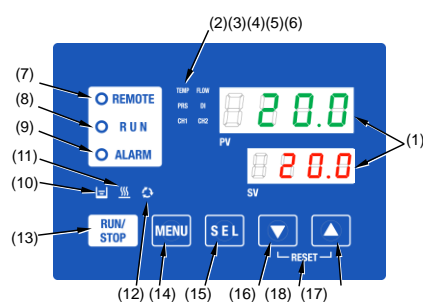

#### 5 Names of Parts and Accessories (continued)

No.	Name	Function
(1)	Digital display (7 segments, 4 digits)	PV Upper line Displays the temperature and pressure of the circulating fluid, alarm codes and other menu items (codes). SV Lower line Displays the set temperature of the circulating fluid and the set values of other menu items.
(2)	[TEMP] light	Turns ON when the temperature is indicated by (1). The indicated value is in (°C).
(3)	[PRS] light	Turns ON when the pressure is indicated by (1). The indicated value is in (MPa).
(4)	[FLOW] light	Not used in this product.
(5)	[DI] light	Turns ON when Electric conductivity is indicated by (1). The indicated value is in (µS/cm).
(6)	[CH1/CH2] light	Turns on the CH that is digitally displayed.
(7)	[REMOTE] light	Allows remote operation (start and stop) via the communication function. Turns ON when operation mode is set to DIO or SERIAL.
(8)	[RUN] light	Turns ON when the product is started and in operation. Turns OFF when the product is stopped. Blinks during stand-by for stop or during anti-freezing operation
(9)	[ALARM] light	Blinks with an alarm sound if an alarm should occur.
(10)	[L] light	Lights ON when the fluid level falls below the "L" (low) level.
(11)	[Anti-freeze] light	Lights ON when the anti-freezing function is enabled. The [RUN] light (8) blinks during anti-freezing operation.
(12)	[Recycle] light	Not used in this product.
(13)	[RUN/STOP] key	Makes the product start or stop.
(14)	[MENU] key	Goes from the main menu (display screen showing circulating fluid temperature, pressure, etc.) to the other menus (entry of setting values and monitor screens).
(15)	[SEL] key	Changes the items in a menu and enters the value of a setting.

No.	Name	Function
(16)	[Down] key	Decreases the set value.
(17)	[Up] key	Increases the set value.
(18)	[RESET] key	Press the [Down] and [Up] keys simultaneously. This will stop the alarm sound and reset the "ALARM" light.

#### 6 Transportation, Transfer and Moving

##### Caution

- Do not set this system on its side during transportation. Oil in the compressor drains into the refrigerant pipe, which causes lubricant shortages, leading to damage to the compressor.
- Drain the remaining fluid out of the pipe as much as possible. The remaining fluid may spill if disregarded.
- Exercise caution not to damage the panel and piping with the forklift when transporting the system.

##### 6.1 Transporting with a Forklift

##### Warning

- This is a heavy product. (Weight: About 140kg)
- Moving the Thermo-chiller by forklift or slinging should be done by licensed persons.
- Forklift insertion positions are on either left or right side of this system. Do not insert from the front or the rear.

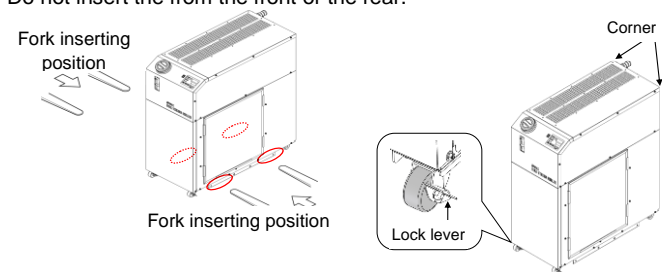

#### 6 Transportation, Transfer and Moving (continued)

##### 6.2 Transporting with Caster

##### Warning

- This is a heavy product. (Weight: About 140kg)
- Moving the product on casters should be done by at least 2 people. Use special caution during transportation when the floor is on an incline.

##### Caution

- Release the caster lock and push the corner of the product. Do not grip the piping or the handles of the panel, as it may cause damage to the product.

#### 7 Installation

##### 7.1 Installation

##### Warning

- Do not install the product unless the safety instructions have been read and understood.
- Do not set up the product in places possibly exposed to leakage of flammable gas. Should any flammable gas get near the product, the product may cause a fire.

##### Caution

- Keep the product upright on a rigid and flat floor which can support the weight of the product and take measures to prevent the product from tipping over. Improper installation may cause water leakage, tipping, damage to the product or injure the operator.
- Keep the ambient temperature of the product between 2 to 45 °C. Operation outside of this ambient temperature range may cause a malfunction of the product. Operating the product in an ambient temperature of 45 °C or higher may reduce the heat discharging efficiency of the heat exchanger and the safety device may trigger, resulting in the product stopping.
- The installer/end user is responsible for carrying out an acoustic noise risk assessment on the equipment after installation and taking appropriate measures as required.

##### 7.2 Environment

##### Warning

- Do not use in an environment where corrosive gases, chemicals, salt water or steam are present.
- Do not use in an explosive atmosphere.
- Do not expose to direct sunlight. Use a suitable protective cover.
- Do not install in a location subject to vibration or impact in excess of the product's specifications.
- Do not mount in a location exposed to radiant heat that would result in temperatures more than the product's specifications.
- This product is not designed for clean room usage. The pump and ventilating fan inside the product generate particles.
- The product must be operated or stored in the following conditions. Potential malfunction or damage to the product may occur if these instructions are disregarded.

For operation or storage locations and conditions refer to operation manual Chapter 3.2.1.

##### 7.3 Location

##### Caution

- This product exhausts heat using the fan mounted to this product.
- If the product is operated with insufficient air ventilation, the internal temperature can exceed 45 °C, which can cause overloaded operation, which will affect the performance and life of the product.
- To prevent this, ensure that suitable ventilation is available (see below).

##### 7.4 Installation of Multiple Products

- Keep sufficient space between products so that the air vented from one product will not be taken in by other products.

##### 7.5 Ventilation

- For a facility having a large installation area (that can vent the air naturally): Make an air outlet in a wall at a high level and an air inlet in a wall at a low level to allow for adequate airflow.
- For a facility having a small installation area (that cannot vent the air naturally): Make a forced air exhaust vent in a wall at a high level and an air inlet in a wall at a low level.

#### 7 Installation (continued)

- Using a duct to exhaust the air: If the indoor site cannot accept the exhausted air from the product or it is air conditioned, ventilate by installing a duct on the ventilation air outlet of the product. Do not fasten the duct directly onto the ventilation air outlet of the product. Install it at least the duct's diameter away from the outlet. Use a fan for the duct for which the ventilation resistance of the duct has been considered.
- Do not install it in an enclosed location.

Model No.	Heat radiation [kW]	Required amount of ventilation [m³/min]	
		Differential temp. of 3 °C between the inside and outside of the installation area	Differential temp. of 6 °C between the inside and outside of the installation area
HRLE050-A-20-※	Approximately 10	140	70
HRLE090-A-20/40-※	Approximately 18	305	155

##### Caution

- The water-cooled product radiates heat to the facility water. It is necessary to supply the facility water. Please prepare the facility water system that satisfies the heat radiation and the facility water specifications below.

##### 7.6 Required facility water system

Model	Heat Radiation [kW]	Facility water specifications
HRLE050-W-20-※	Approx. 10	Refer to operation manual [chapter 9.1 Specifications]
HRLE090-W-※-※	Approx. 20	

##### 7.7 Installation and Maintenance Space

##### Caution

- Make sure there is enough space for ventilation of the product. Otherwise it may cause a lack of cooling capacity or stoppage of the product.
- Ensure there is enough space for maintenance.

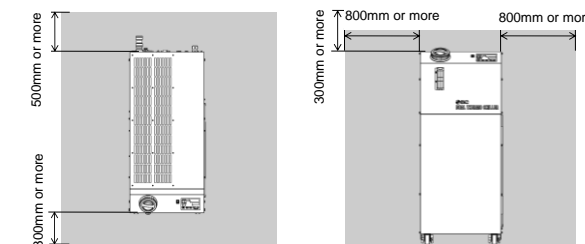

##### 7.8 Installation Procedure

##### Caution

- Install the product on a level, vibration-free floor.
- Prepare M10 anchor bolts that are suitable for the material of the floor that the product will be installed on.
- Drive the anchor bolts in at least two places on the left and right sides of the product (four places in total). Refer to operation manual chapter "9.3 Dimensions" for the dimensions for the positions of the anchor bolts.

##### 7.9 Fixture

Use the fixtures and holding screws currently used for holding the product to the wooden box to secure the product to the floor using anchor bolts.

- Install anchor bolts on a level floor with the dimensions below.
- Set the fixtures from the top of the anchor bolts.

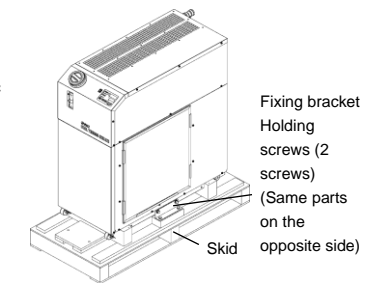

## 7 Installation (continued)

3. Set hexagon screws to the anchor bolts and screw the holding screws into the product to secure the product to the floor. The fixtures are mounted to the front and rear surface of the product (2 places).

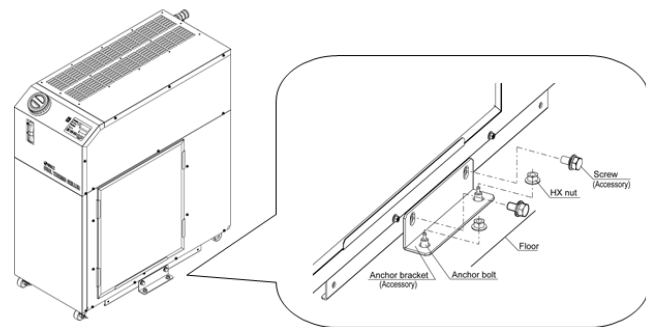

### 7.10 Electrical Wiring

#### Warning

- Do not modify the internal electrical wiring of the product. Incorrect wiring may cause electric shock or fire. Also, modifying the internal wiring will void the product's warranty.
- Never connect the ground to a water line, gas pipe or lightning conductor.
- The electrical facilities should be installed and wired in accordance with local laws and regulations of each country by a person who has knowledge and experience.
- Be sure to shut off the user's power supply before any wiring work. Wiring with the product energized is strictly prohibited.
- The wiring must be conducted using cables complying with "Table 3-3 Power supply cable and earth leakage (Recommended)" of the operation manual and be firmly secured to the product to prevent the external force of the cables from being applied to the terminals. Incomplete wiring, or improper securing of wiring, may cause electric shock or excessive heat and fire.
- Ensure that an earth leakage breaker is used in the power supply of the product.
- Use a power supply suitable for the specifications of the product. Use a power supply of overvoltage category 3 (IEC60664-1).

- Be sure to connect the ground connection.
- Ensure that a lock out facility is available on the power supply.
- Each product must have its own separate connection to the power supply. Mixing wiring with other equipment is risky and may cause electric shock or fire. Never attempt to do this.
- Ensure that no harmonics are superimposed on the power supply. (Do not use an inverter, etc.)
- Supply a steady power supply which is not affected by surges or distortion. If the voltage rise rate (dv/dt) at zero crossing exceeds 40 V/200 μsec, it may cause a malfunction.

#### 7.10.1 Power Supply Specifications, Power Supply Cable, and Earth Leakage Breaker

Prepare the power supply shown in the following table. For the connection between the product and power supply, use the power supply cable and earth leakage breaker shown below. An earth leakage breaker must be mounted to a position where the breaker is easily accessible and close to the Thermo-chiller.

Power supply cable and earth leakage (Recommended)

Model	Power supply voltage	Terminal block screw diameter	Crimp terminal	Cable qty. x size	Earth leakage breaker	
					Rated current [A]	Sensitivity of leak current [mA]
HRLE050-※-20	Single Phase 200 to 230 VAC (50/60Hz)	M5	R5.5-5	3 cores x 5.5 mm <sup>2</sup> (3 cores x AWG10) * Including ground	30	30
HRLE090-※-20	3 phase 200 VAC (50Hz) 3 phase 200 to 230 VAC (60Hz)	M5	R5.5-5	4 cores x 5.5 mm <sup>2</sup> (4 cores x AWG10) * Including ground	30	
HRLE090-※-40	3 phase 380 to 415 VAC (50Hz) 3 phase 460 to 480 VAC (60Hz)	M8	R5.5-8	4 cores x 5.5 mm <sup>2</sup> (4 cores x AWG10) * Including ground	20	

\*Cable specifications are examples for when using the product at a continuous allowable operating temperature of 70 °C, with an operating voltage of 600 V and two kinds of plastic insulated wires at an ambient temperature of 30 °C. Please select the proper size cables according to the actual condition.

## 7 Installation (continued)

### 7.10.2 Grounding

Be sure to ground the product (PE). Do not share the ground with equipment that generates strong noise or high frequencies. Grounding class: D-class grounding (with a ground resistance of 100 Ω or less).

### 7.11 Preparation and Wiring of Power Supply Cable

#### Warning

- The electrical facilities should be installed and wired in accordance with local laws and regulations of each country by a person who has knowledge and experience.
- Check the power supply. Operation with voltages, capacities, and frequencies other than the specified values can cause fire and electric shock.
- Wire with an applicable cable size and terminals. Forced mounting with a cable or terminals of an unsuitable size may result in heat generation or fire.
- Be sure to lock out and tag out the breaker of the facility power supply (user's power supply) before wiring.
- Be sure to connect the power supply cable from the product side first, and then connect the breaker of the facility power supply (the user's power supply facility).

#### Power Supply Cable Wiring

- Remove the 4 screws to allow removal of the power supply terminal cover on the back of the product.
- Insert the power supply cable and ground cable through the power supply cable entry of the power supply terminal cover (cable accessory).
- Connect the power supply cable and ground wire as shown below.

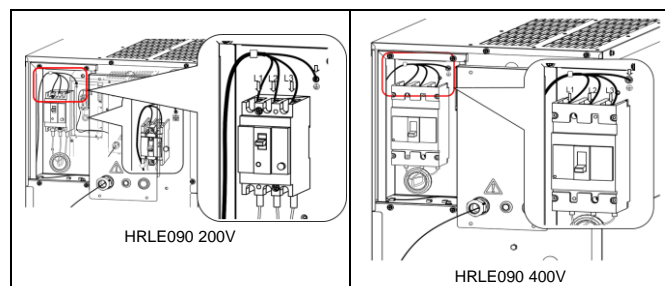
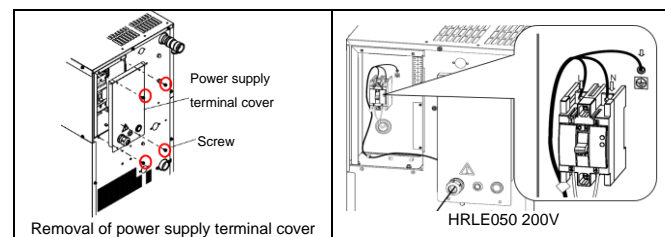

### 7.12 Piping

#### Caution

- Connect piping firmly. Incorrect piping might cause leakage of supplied or drained fluid getting the area wet, causing malfunction of the product or other facilities.
- Use caution to not allow dust and foreign matter to enter the water circuit, etc. during piping work.
- During piping work, residual liquid may drip from the circulating fluid circuit. Prepare a basin close to the piping connection to catch the residual liquid.
- Securely connect the piping at the piping port with a pipe wrench when tightening.
- The piping should be selected with due consideration of pressure and temperature.
- Use non-corrosive materials for parts that come in contact with circulating fluid. Using materials, such as aluminium or iron, that tend to rust or corrode for parts that come in contact with fluid may not only cause clogs in the circulating fluid circuits and leakage of the circulating fluid, but also leakage of refrigerant (CFC), causing unexpected problems. When using these kinds of materials, the customer needs to implement some preventive measures against rust and corrosion.

## 7 Installation (continued)

- Do not generate a rapid change in pressure with a water hammer, etc. Internal parts of the chiller and/or the piping may be damaged.

Name	Port size	Recommended tightening torque	Recommended piping specifications
Circulating fluid outlet/return port (CH1)*1	Rc1/2	28 to 30 N·m	1.0 MPa or more
Circulating fluid outlet/return port (CH1)*2	Rc1	36 to 38 N·m	1.0 MPa or more
Circulating fluid outlet/return port (CH2)	Rc1/2	28 to 30 N·m	1.0 MPa or more
Drain port	Rc1/4	8 to 12 N·m	-
Facility water inlet *3	Rc1/2	28 to 30 N·m	1.0MPa or more (Supply pressure: 0.3 to 0.5MPa)
Facility water outlet *3	Rc1/2	28 to 30 N·m	1.0MPa or more (Automatic water-fill pressure: 0.2 to 0.5MPa)
Automatic water-fill port *4	Rc3/8	22 to 24 N·m	1.0MPa or more (Automatic water-fill pressure: 0.2 to 0.5MPa)
Overflow port *4	Rc3/4	28 to 30 N·m	of piping 19mm or more

\*1: HRLE050 only, \*2: HRLE090 only, \*3: Water cooled type only

\*4: For HRL-JK001 [Automatic fluid filling]

### 7.13 Circulating Fluid Supply

Turn the tank lid counter clockwise to open. Supply the circulating fluid up to the "H" mark on the fluid level indicator. Use tap water which satisfies the water quality standard shown in Operation Manual "section 8.1" or deionized water (pure water).

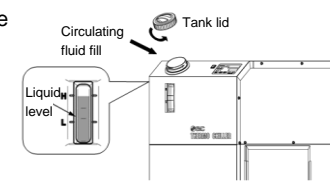

#### Caution

- When deionized water is used, the conductivity should be 0.4 μS/cm or higher (Electrical resistivity: 2.5 MΩ·cm or lower).
- Check that the drain port is closed with the valve to prevent the supplied circulating fluid from draining out.
- Supply recirculating fluid up to the "H" mark of the tank.
- Operation will stop when the fluid level falls lower than "L".

## 8 Starting the Product

### 8.1 Before Starting

Check the following points before starting the product. Installation state

- Check that the product is installed horizontally.
- Check that there are no heavy objects on the product, and the external piping is not applying excessive force to the product.
- Connection of cables
- Check that the power, ground, and communication signal cables (to be supplied by the user) are correctly connected.
- Circulating fluid piping
- Check that the circulating fluid piping is correctly connected to the inlet and outlet.
- Fluid level gauge
- Confirm that the fluid level is between the "H" and "L" levels of the fluid level gauge.

### 8.2 Preparation for Start

#### 8.2.1 Power Supply

- Turn ON the breaker of the user's power supply. (Make sure that the breaker on the back of the product is turned on.)
- Turn on the power supply switch on the front surface. When the product is switched ON correctly, the operation panel display operates as shown below:



- The initial screen (HELLO screen) is displayed on the operation display panel. Then, the display changes to the main screen which shows the circulating fluid outlet temperature. \* When an alarm is generated, the alarm screen appears.
- The current circulating fluid temperature is displayed as PV on the digital display.
- The set circulating fluid temperature is displayed as SV on the digital display.

## 8 Starting the Product (continued)

### 8.3.1 Setting of Circulating Fluid Temperature

Press the [▼] or [▲] key on the operation panel to change the SV to the required value.

### 8.4 Operation Start and Stop

#### 8.4.1 Starting the Product

#### Caution

- Allow at least 5 minutes before restarting the product.

Press the [RUN/STOP] key on the operation panel. The [RUN] light (green) turns ON and the product starts running. The circulating fluid discharge temperature (PV) is controlled at the set temperature (SV).

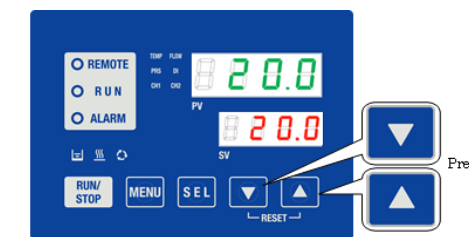

Setting of circulating fluid temperature

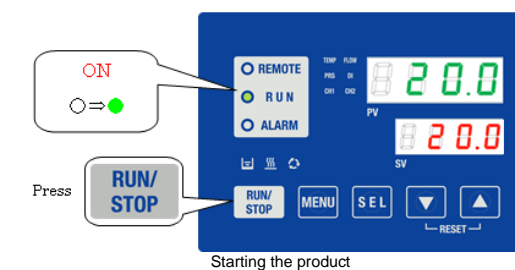

Starting the product

### 8.4.2 Stopping the Product

- Press the [RUN/STOP] key on the operation panel.

The [RUN] light on the operation panel blinks green and continues operation to prepare to stop. After approximately 20 seconds, the [RUN] light turns OFF and the operation stops completely.

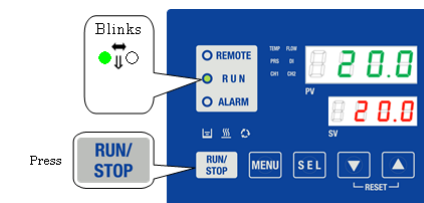

- Turn off the power supply switch. Turn OFF the user's power supply (power supply breaker) as needed.

#### Caution

- Do not turn OFF the breaker before the Thermo-chiller stops operation completely except in an emergency. It may damage the product.

## 9 Alarm Notification and Troubleshooting

### 9.1 Troubleshooting

#### 9.1.1 Alarm Details, Causes, and Troubleshooting

Troubleshooting method varies depending on which alarm has been generated. Refer to Operation Manual "Table 7-1 Alarm codes and troubleshooting" for handling.

- Confirm that the alarm display screen is shown.
- Alarms can only be reset on this screen.
- Press the [▼] and [▲] buttons simultaneously.
- The alarm is reset.
- The [ALARM] light turns OFF.
- The operation panel displays the circulating fluid temperature and the set circulating fluid temperature.
- Contact signal output for contact input/output communication stops.
- (Refer to the Operation Manual Communication Function for details.)

**9 Alarm Notification and Troubleshooting (continued)**



\* The [AL] light turns ON only when the "AL01 Low level in tank" alarm is generated.

**Alarm codes and troubleshooting**

No.	Details	Operating conditions	Recovery	Possible causes	Countermeasures
AL01	Low level in tank	Stop	Manually	Low level in tank, broken wire in the liquid level sensor.	Check if there is a broken wire in the liquid level sensor and add circulating fluid.
AL02	CH1 High circulating fluid temp.	Stop	Manually	High ambient temperature, high heat load.	Check the ambient temperature and heat load are within the specified ranges.
AL05	High circulating fluid return temp.	Stop	Manually	Circulating fluid not flowing, high heat load.	Check the circulating fluid flow and heat load are within the specified ranges.
AL06	High circulating fluid discharge pressure	Stop	Manually	Bent, pinched, clogged piping.	Check the user's piping for bends, pinching or clogging.
AL08	Circulating fluid discharge pressure rise	Stop (note1)	Manually	Bent, pinched, clogged piping.	Check the user's piping for bends, pinching or clogging. Check the settings.
AL09	Circulating fluid discharge pressure drop	Stop (note1)	Manually	Failure of pump.	Check the pump is operating. Check the settings.
AL11	Low compressor suction temp.	Stop	Manually	Circulating fluid not flowing (low flow rate). Freezing in the circulating fluid in the heat exchanger.	Check the heat load circulating and fluid flow rate are within the specified ranges.
AL13	Abnormal high-side refrigerant pressure rise	Stop	Manually	High ambient temperature, high heat load. Clogging in the condenser or filter.	Check that the ambient temperature and heat load are within the specified ranges and that there is no clogging in the condenser and filter.
AL15	Refrigerant leakage	Stop	Manually	Refrigerant is leaking.	Ask for the service for the refrigerant circuted.
AL16	Abnormal low-side refrigerant pressure rise	Stop	Manually	High ambient temperature, high heat load.	Check the ambient temperature and heat load are within the specified ranges.
AL17	Abnormal low-side refrigerant pressure drop	Stop	Manually	Circulating fluid not flowing.	Check the circulating fluid flow is within the specified ranges.

AL18	Compressor running failure	Stop	Manually	Abnormality in the power supply (short circuit, voltage fluctuation, etc.), failure of compressor.	Stop the chiller for 10 minutes, and then restart it. Check if the compressor operates. If it does not recover, ask for service to replace the compressor.
AL19	Communication error	Stop (note2)	Automatic	Error occurred in the communication.	Check the communication settings.
AL22	CH1 circulating fluid discharge temp. sensor failure	Stop	Manually		Ask for the service for the temperature sensor (PT1).
AL23	Circulating fluid return temp. sensor failure	Stop	Manually	The temperature sensor is short-circuited or disconnected.	Ask for the service for the temperature sensor (PT2).
AL24	Compressor suction temp. sensor failure	Stop	Manually		Ask for the service for the temperature sensor (TH2).
AL25	Circulating fluid discharge pressure sensor failure	Stop	Manually		Ask for the service for the pressure sensor (PS1).
AL26	Refrigerant circuit high pressure sensor failure	Stop	Manually	The pressure sensor is short-circuited or disconnected.	Ask for the service for the pressure sensor (PS2).
AL27	Refrigerant circuit low pressure sensor failure	Stop	Manually		Ask for the service for the pressure sensor (PS3).
AL31	Contact input 1 signal detection	Stop (note2)	Manually	Contact input has been detected.	Check the contact input. If the error occurs again, ask for the service for the compressor.
AL32	Contact input 2 signal detection	Stop (note2)	Manually		Check the contact input.
AL34 (note3)	Electric conductivity rise	Operation continued	Automatic	Timing to replace the DI filter.	Replace the DI filter.
AL35 (note3)	Electric conductivity decrease	Operation continued	Automatic	Failure of solenoid valve.	Ask for the service for the solenoid valve.
AL36 (note3)	Electric conductivity sensor failure	Operation continued	Manually	Failure of DI sensor.	Ask for the service for the DI sensor.
AL37	Compressor discharge temp. sensor failure	Operation continued	Manually	The temperature sensor is short-circuited or disconnected.	Ask for the service for the temperature sensor (TH1).
AL38	Compressor discharge temp. rise	Stop	Manually	High ambient temperature, high heat load.	Check the ambient temperature and heat load are within the specified ranges.
AL43 (note8)	Fan failure	Stop	Manually	Failure of fan.	Ask for the service for the fan.
AL46 (note4)	Compressor inverter error	Stop	Manually	Error occurred in the compressor or inverter for compressor.	Reset the pressure switch. If it does not recover, ask for the service for the compressor/inverter of the compressor.
AL47 (note7)	Pump running failure	Stop	Manually	Error occurred in the pump.	Check the power supply is not error. (Ground-fault, short-circuit, voltage fluctuation, abnormal phase voltage, open phase, surge, etc.) Reset the thermal relay for the pump.
AL48 (note5)	Pump inverter error	Stop	Manually	Error occurred in the pump or inverter for pump.	Ask for the service for the pump/inverter of the pump.

**9 Alarm Notification and Troubleshooting (continued)**

AL50	CH2 Circulating fluid temp. is too high	Stop	Manually	High ambient temperature, high heat load.	Check the ambient temperature and heat load are within the specified ranges.
AL51	CH2 Circulating fluid discharge temp. sensor failure	Stop	Manually	The temperature sensor is short-circuited or disconnected.	Ask for the service for the temperature sensor (PT3).
AL52	Memory error 1	Stop	Restart		Check the power supply is not error. (Ground-fault, short-circuit, voltage fluctuation, abnormal phase voltage, open phase, surge, etc.) and restart the thermo-chiller.
AL53	Memory error 2	Stop	Restart		Check the power supply is not error. (Ground-fault, short-circuit, voltage fluctuation, abnormal phase voltage, open phase, surge, etc.) and restart the thermo-chiller.
AL56 (note6)	Abnormal missing phase / anti-phase	Stop	Manually	Error occurred in the power supply miswiring).	Check the power supply has no error. (Ground-fault, short-circuit, voltage fluctuation, abnormal phase voltage, open phase, surge, etc.) and restart the thermo-chiller. If it does not recover, ask for the service for the circuit board.
AL57 (note4)	Compressor inverter communication error	Stop	Manually	Error occurred in the inverter for compressor.	Ask for the service for the inverter of the compressor.
AL58 (note5)	Pump inverter parameter error	Stop	Restart	Error occurred in the parameter of the inverter for pump.	Ask for the service for the inverter of the pump.
AL59 (note5)	Pump inverter communication error	Stop	Manually	Error occurred in the inverter for pump.	Ask for the service for the inverter of the pump.
AL62	Internal communication error	Stop	Restart	Abnormality in the power supply (short circuit, voltage fluctuation, etc.).	Check the power supply has no error. (Ground-fault, short-circuit, voltage fluctuation, abnormal phase voltage, open phase, surge, etc.) and restart the thermo-chiller. If it does not recover, ask for the service for the circuit board.
AL63	Abnormal high-side refrigerant pressure rise	Operation continued	Manually	High ambient temperature, high heat load. Clogging in the condenser or filter.	Check the ambient temperature and heat load are within the specified ranges. Check the clogging of the filter or condenser.
AL64	Power supply failure	Stop	Restart	Error occurred in power supply.	Check the power supply and restart the thermo chiller.
AL65	Refrigerant high-pressure switch operated	Stop	Manually	Failure of fan.	Ask for the service for the fan.
AL66 (note4)	Compressor inverter parameter error	Stop	Restart	Error occurred in the parameter of the inverter for compressor.	Ask for the service for the inverter of the compressor.

(Note 1) Initial value. User can change to Continued.  
 (Note 2) Initial value. User can change to Off or Continued.  
 (Note 3) Occurs only when the Electric conductivity control function is enabled.  
 (Note 4) Option C only.  
 (Note 5) Option P only.  
 (Note 6) Not generated for option C.  
 (Note 7) Not generated for option P.  
 (Note 8) Not generated for water cooled type.

**10 Maintenance**

**10.1 General Maintenance**



- Do not operate switches, etc. with wet hands and do not touch the electrical parts such as the power supply plug. It might cause electric shock.
- Do not splash water directly on the product and do not wash with water. It might cause electric shock and fire, etc.
- Do not touch the fins directly when cleaning the dustproof filter. It might cause injury.
- Remount all panels removed for inspection or cleaning. As this might cause injury or electric shock if the product is operated without the panels.



- Not following proper maintenance procedures could cause the product to malfunction and lead to equipment damage.
- Before performing maintenance, turn off the power supply. After installation and maintenance, turn on power to the equipment and perform appropriate functional and leakage tests to make sure the equipment is installed correctly.
- Do not make any modification to the product.
- Do not disassemble the product, unless required by installation or maintenance instructions.

**10.2 Quality Control of Circulating Fluid and Facility Water**



- Use specified fluids only. If other fluids are used, they may damage the product, causing fluid leakage, or result in hazards such as electric shock or leakage of electricity.
- When using clear water (tap water), ensure that it satisfies the water quality criteria shown in the table below. If the water quality standards are not met, clogging or leakage in the facility may occur.

**10 Maintenance (continued)**

**10.3 Inspection and Cleaning**

**10.3.1 Daily Check Items**

Item	Content of check	
Installation conditions	Check the installation condition of the product.	Check that there is no heavy object on the product or excessive force being applied to the piping. The temperature should be within the specification range of the product. Make sure the ventilation grille is not obstructed. (Air-cooled type)
Fluid leakage	Check the connected parts of the piping.	Check that there is no fluid leakage from the connected parts of the piping.
Amount of circulating fluid	Check the fluid level meter.	The fluid level should be between the "H" and "L" levels of the fluid level meter.
Operation panel	Check the indications on the display.	Numbers shown on the display should be clear and legible.
	Check the functionality.	Check that the buttons, [RUN/STOP], [MENU], [SEL], [▼], and [▲], operate correctly.
Circulating fluid temperature	Check on the operation panel.	There should be no problem for operation.
Circulating fluid discharge pressure	Check on the operation panel.	There should be no problem for operation.
Operating condition	Check the operating condition of the product.	There should be no abnormalities involving noise, vibration, smell, or generation of smoke. There should be no active alarm signals.
Ventilating condition (Air-cooled refrigerating type)	Check the condition of the ventilation grille.	Make sure the ventilation grille is not obstructed.
Facility water (water cooled type)	Facility water condition	Temperature, pressure and flow rate are within the specified range of the product

**10.3.2 Monthly Check Items**

Item	Content of check	
Ventilating condition (Air-cooled type)	Clean the ventilation grille.	Make sure the ventilation grille is not clogged with dust, etc.

**Cleaning the Ventilation Grille**



- If the fins of the air-cooled condenser become clogged with dust or debris, heat radiation performance declines. This will result in a reduction of the cooling performance and may stop the operation if the safety device is triggered.
- Clean the dust-proof filters with a long-bristled brush or by blowing air to prevent the fins from being deformed or damaged.

**Removal of the Dust-Proof Filter**

- A dust-proof filter is installed on the right side of the product.
- Raise the dust-proof filter as shown below. Care should be taken not to deform or scratch the air-cooled condenser (fins) while removing the filter.

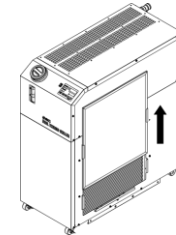

**Cleaning the Dust-Proof Filter**

Clean the dust-proof filters with a long-bristled brush or by blowing air.

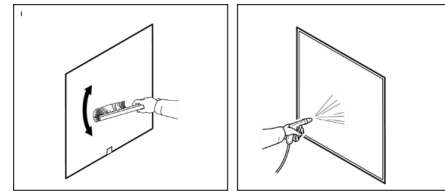

**Mounting the Dust-Proof Filter**

Reassemble the filter in the reverse order to removal.

**10.3.3 Content of 3-month Inspections**

Item	Content of check	
Power supply	Check the power supply voltage.	Make sure the supply voltage is within the specification range.
Circulating fluid	Replace the circulating liquid (clean water) periodically.	Ensure that the water has not been contaminated and that there is no algae growth. Circulating water inside the tank must be clean and there must not be foreign matter in it. The quality of the [clean water/pure water] must be within the range shown in Operation Manual "Table 8-1 Water quality criteria for clear water (tap water)". It is recommended to replace the circulating fluid every 3 months when periodic maintenance is performed.

**10 Maintenance (continued)**

**10.3.4 6-month Inspections**



- Leakage from the mechanical seal: It is impossible to prevent leakage from the mechanical seal completely because of its structure. The leakage is 3 cc/hr or less.
- The recommend lifetime of the mechanical seal before needing replacement is 6000 to 8000 hours.

Remove the panel and inspect if there is abnormal leakage from the pump. If any leakage is found, the mechanical seal needs to be replaced. Order the mechanical seal described in Operation Manual chapter "8.3 Consumables" as a service part.

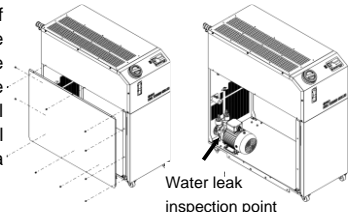

**10.3.5 Inspection During Winter Season**

For more details, refer to Operation Manual chapter "8.2.5 Inspection during winter season."

**10.4 Consumables**

Part No.	Name	Qty.	Model No.		Remarks
			HRLE050	HRLE090	
IDF-S0535	Dust-proof filter	1	●	●	1 piece is used per unit
HRS-S0307	Mechanical seal set	1	●	●	1 set is used per unit
HRS-S0350	Mechanical seal set	1	●	●	1 set is used per unit (For option M)
HRR-DF001	DI filter	1	●	●	Please order when using HRL-DI001 and DI002.
HRG-S0211	Mechanical seal set	1	●	●	1 set is used per unit

**11 Limitations of Use**

**11.1 Limited Warranty and Disclaimer/Compliance Requirements**

Refer to Handling Precautions for SMC Products.  
 Refer to 'Section 2. Specifications for the product limitations of use.

**12 Product Disposal**

This product shall not be disposed of as municipal waste. Check your local regulations and guidelines to dispose this product correctly, in order to reduce the impact on human health and the environment.

**13 Declaration of Conformity**

Below are sample Declaration of Conformities (DoC) used for this product.

**EU DECLARATION OF CONFORMITY**

SMC Corporation, 4-14-1, Sotokanda, Chiyoda-ku, Tokyo 101-0021, JAPAN, declares under its sole responsibility, that the following equipment:

**Thermo Chiller**  
**HRLE Series**  
 Serial No. Z1901 onwards Marked H

is in conformity with the requirements with reference to the harmonized standard(s) or applied standard(s) as listed below:

2006/42/EC (Machinery Directive), Annex I EN ISO 12100:2010 EN ISO 12101:2010  
 2014/53/EU (EMC Directive), Annex I EN 55032:2015 EN 55034:4:2007+11:2011  
 2011/65/EU (RoHS Directive), Annex II EN 60950-2:2013

Tokyo, Date: \*\* Jun 2021

**UK DECLARATION OF CONFORMITY**

SMC Corporation, 4-14-1, Sotokanda, Chiyoda-ku, Tokyo 101-0021, JAPAN, declares under its sole responsibility, that the following equipment:

**Thermo Chiller**  
**HRLE Series**  
 Serial No. Z1901 onwards Marked H

is in conformity with the requirements with reference to the designated standards as listed below:

EMC Directive, 2011/65/EU (RoHS Directive), 2006/42/EC (Machinery Directive)

The person authorised to compile the technical file is the person named at the address below:

Tokyo Date: \*\* Jun 2021

**14 Contacts**

Refer to [www.smcworld.com](http://www.smcworld.com) or [www.smc.eu](http://www.smc.eu) for your local distributor/importer.

**SMC Corporation**

URL : <https://www.smcworld.com> (Global) <https://www.smc.eu> (Europe)  
 SMC Corporation, 4-14-1, Sotokanda, Chiyoda-ku, Tokyo 101-0021, Japan  
 Specifications are subject to change without prior notice from the manufacturer.  
 © 2022 SMC Corporation All Rights Reserved.