

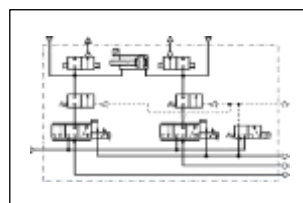

ORIGINAL INSTRUCTIONS

Instruction Manual
Air Servo Cylinder
IN-777 Series



The intended use of an Air Servo Cylinder is to convert energy from compressed air in linear motion and have multi-point positioning functionality.

1 Safety Instructions

These safety instructions are intended to prevent hazardous situations and/or equipment damage. These instructions indicate the level of potential hazard with the labels of "Caution," "Warning" or "Danger." They are all important notes for safety and must be followed in addition to International Standards (ISO/IEC)^{*1}, and other safety regulations.

- ^{*1} ISO 4414: Pneumatic fluid power - General rules relating to systems.
- ISO 4413: Hydraulic fluid power - General rules relating to systems.
- IEC 60204-1: Safety of machinery - Electrical equipment of machines. (Part 1: General requirements)
- ISO 10218-1: Robots and robotic devices - Safety requirements for industrial robots - Part 1: Robots.

- Refer to product catalogue, Operation Manual and Handling Precautions for SMC Products for additional information.
- Keep this manual in a safe place for future reference.

	Caution	Caution indicates a hazard with a low level of risk which, if not avoided, could result in minor or moderate injury.
	Warning	Warning indicates a hazard with a medium level of risk which, if not avoided, could result in death or serious injury.
	Danger	Danger indicates a hazard with a high level of risk which, if not avoided, will result in death or serious injury.

Warning

- Always ensure compliance with relevant safety laws and standards.
- All work must be carried out in a safe manner by a qualified person in compliance with applicable national regulations.

2 Specifications

2.1 Product Specification

Fluid	Air
Filtration of compressed air	0.3 μm or less
Proof pressure	1.2 MPa
Operating pressure range	0.55 MPa to 0.8 MPa
Repeated stop position accuracy	+/-0.5 mm or less ^{*1}
Ambient temperature	Refer to *2
Fluid temperature	-20 to 60°C (No freezing)
Operating humidity	35-85% (No condensation)
Installation altitude	0 to 5,000 m
Housing protection	IP67
Standard	RoHS compliant
Weight	Refer to Table 1
Mounting orientation	Vertical downward
Allowable lateral load at rod end	Refer to Table 2

^{*1} Based on the SMC's test conditions

^{*2} -20 °C to 60 °C (With rod boot of silicone rubber material and without rod boot)
-10 °C to 60 °C (With rod boot of nylon tarpaulin)
(No freezing)

2 Specifications (continued)

Table 1 Weight

Bore size (mm)	Stroke (mm)	Weight (kg)
125	250	24
	200	37
160	300	43
	200	53
200	300	61
	350	86
250	450	97
	200	100
320	350	129
	530	163

Table 2 Allowable lateral load at rod end

Bore size (mm)	Allowable lateral load at rod end (N)
125	100
160	140
200	240
250	280
320	420

2.2 Electrical Specification

Power supply	Applied voltage: 24 VDC±10% Current consumption: 0.5 A (Max.2.5 A)
Control system	Closed loop
Positioning sensor	Absolute
Analog input signal	4 to 20 mADC
Analog input impedance	Approx. 250 Ω
Analog output signal	4 to 20 mADC
Maximum load impedance (Analog output)	500 Ω
Switch input signal	4 points, Connected to +24 VDC±/-10% Current consumption: 10 mA or less
Switch output signal	5 points, N-type MOSFET Open source output Maximum load current: 100 mA

2.3 Air Circuit

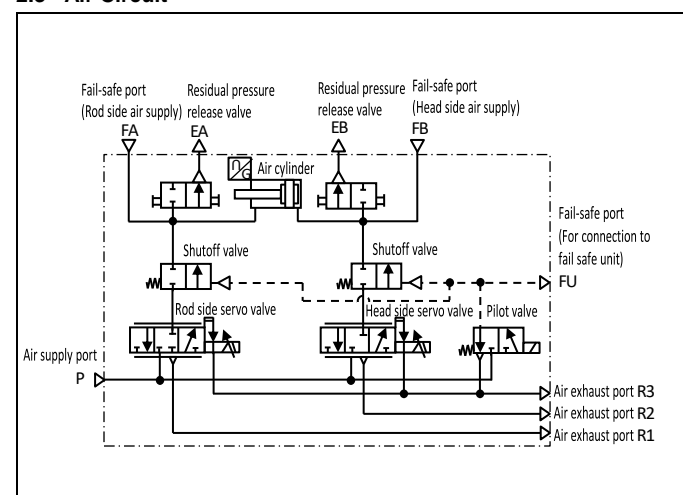

3 Installation

3.1 Installation

Warning

- Do not install the product unless the safety instructions have been read and understood.

3.1.1 Installation

Mount the flange to the base and secure with screws using the screw through holes.

3 Installation (continued)

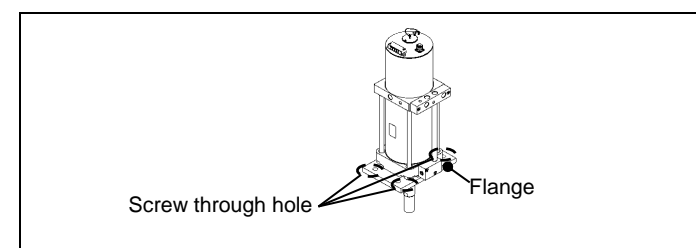

Bore Size (mm)	Screw through hole size (mm)	Size of screw	Thickness of flange (mm)
125	16	M14	20
160	18	M16	20
200	22	M20	25
250	26	M22	25
320	33	M30	30

Caution

When installing the product, do not apply an excessive external force or impact to the cover tube and piping tube. This may damage the controller in the cover tube and the piping tube and power supply connector. Applying excessive external force to the piping may result in damage to the piping or a malfunction. As screw holes for installing eye bolts are provided on the head covers of sizes ø160 and larger, insert the eye bolts into the screw holes and hang the product to mount it.

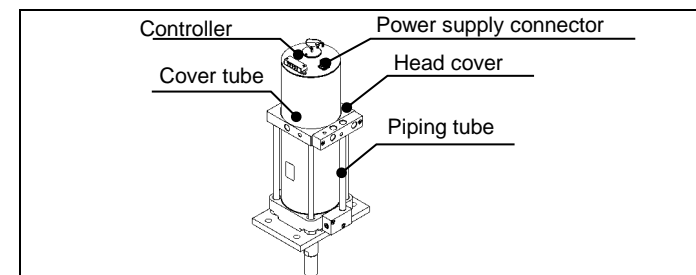

Caution

Do not allow foreign matter such as cutting chips inside the cylinder from the ports.

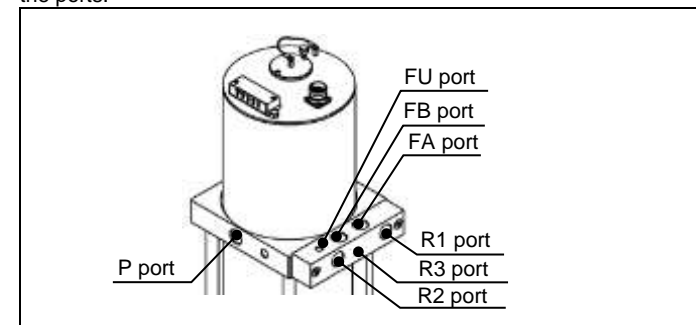

3 Installation (continued)

3.1.2 Electrical Wiring Diagram

Perform wiring according to the connector pin numbers and the wiring diagram. (Connector pin numbers – shown from the Male Side).

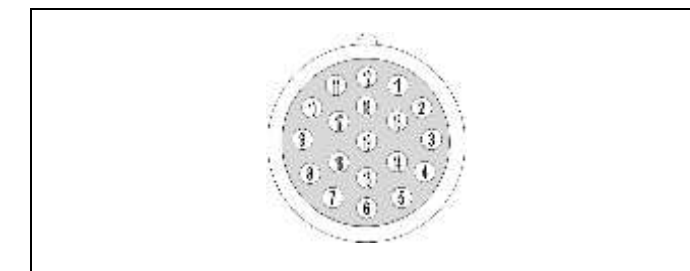

Pin No.	Signal name	Input/output status	Description
1	Sig-in+	Input	4-20 mA analog input signal (+), (with HART *1)
2	Sig-in-	Input	4-20 mA analog input signal (-), (with HART *1)
3	JOG+	Input	JOG operation signal (Move to the extended end direction)
4	JOG-	Input	JOG operation signal (Move to the retracted end direction)
5	PWR DC24V		+24 VDC Power supply
6	PWR GND		Power supply GND
7	Pos-out+	Output	4-20 mA analog output signal (+)
8	Pos-out-	Output	4-20 mA analog output signal (-)
9	CTR	Output	Controller normal signal

10	CYL	Output	Positioning sensor error signal
11	VAL	Output	Valve error signal
12	GND_I/O	—	Input/output signal GND
13	CAL	Input	Calibration signal
14	E-STOP		Emergency stop signal (Negative edge triggered *2)
15	-	-	-
16	RF	Output	Piston rod worn error signal
17	PWR	Output	Power supply error signal
18	-	-	-
19	-	-	-

^{*1} When selecting HART communication protocol by How to order.

^{*2} Emergency stop is performed when signal is OFF.

3.2 Environment

Warning

- Do not use in an environment where corrosive gases, chemicals, salt water or steam are present.
- Do not use in an explosive atmosphere.
- Do not expose to direct sunlight. Use a suitable protective cover.
- Do not install in a location subject to vibration or impact in excess of the product's specifications.
- Do not mount in a location exposed to radiant heat that would result in temperatures in excess of the product's specifications.

3.3 Piping

Caution

- Before connecting piping make sure to clean up chips, cutting oil, dust etc.
- When installing piping or fittings, ensure sealant material does not enter inside the port. When using seal tape, leave 1.5 to 2 threads exposed on the end of the pipe/fitting.
- Tighten fittings to the specified tightening torque.

3 Installation (continued)

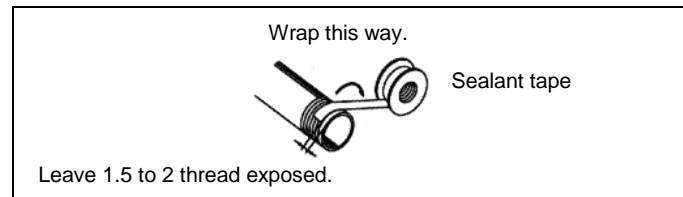

3.4 Lubrication

Caution

- SMC products have been lubricated for life at manufacture, and do not require lubrication in service.
- If a lubricant is used in the system, refer to catalogue for details.

4 Settings

Perform the DIP switch setting for normal/reversed switching of the piston rod travel direction (during target position operation), cylinder bore size, and piston rod operating direction at no signal operation. By performing the rotary switch setting, the piston rod speed during target position operation can be set.

With the power to the air servo cylinder disconnected, remove the hexagon socket head cap screws to remove the switch cover from the panel. Using the DIP switch and rotary switch mounted inside the switch cover, perform setting whilst referring to the procedure below.

Caution

If the settings of the DIP switch and rotary switch are changed while power is supplied, the setting will not become effective. Changes to the DIP switch and rotary switch setting should be performed with no power supplied to the product.

Set up required steps:

- Set the DIP switch (Refer to section 4.1, 4.2 and 4.3).
- Set the rotary switch (Refer to section 4.4).
- Supply power.

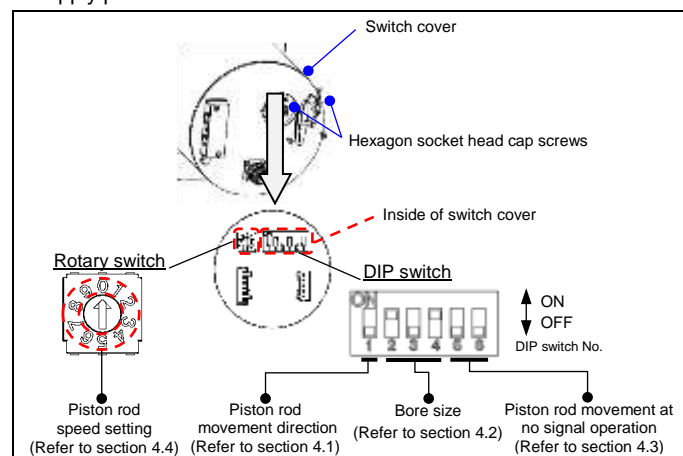

After setting, push the switch cover into the panel hole and replace the 2 hexagon socket head cap screws.

(Recommended tightening torque: 0.5 N·m to 0.75 N·m).

4.1 Piston Rod Movement Direction [DIP Switch #1]

The piston rod movement direction relative to the analogue input signal (4-20 mA) can be set, for when the target position operation is performed.

DIP Switch #1	Direction	Relationship between the analog input signal and the piston rod direction of movement
OFF (Default)	Standard	

4 Settings (continued)

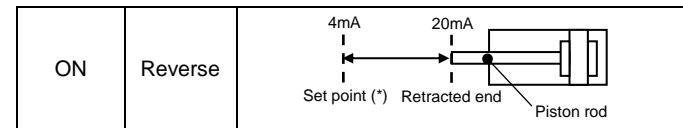

* Set point: Position set by calibration (Refer to section 4.5.2 for details)

4.2 Bore Size [DIP Switches #2, #3 and #4]

DIP Switch #2	DIP Switch #3	DIP Switch #4	Bore size
ON	OFF	OFF	Ø125
OFF	ON	OFF	Ø160
ON	ON	OFF	Ø200
OFF	OFF	ON	Ø250
ON	OFF	ON	Ø320
OFF	ON	ON	Don't use.

If all switches are set to ON or OFF, a cylinder bore setting error will occur and an alarm will be generated (Refer to section 4.6). Change the setting of the DIP switch correctly.

4.3 Piston Rod Movement at No Signal Operation [DIP Switches #5 and #6]

Set the piston rod operation at no signal operation (Refer to section 4.5.4) using DIP switch No. 5 and No. 6. The piston rod operation setting can be selected from "Stops after moving to the retracted end", "Stops after moving to the set point", or "Current position retained".

DIP Switch #5	DIP Switch #6	Piston Rod Operation
OFF	OFF	Cylinder stops after moving to the retracted end

ON	OFF	Cylinder stops after moving to the set point
ON / OFF	ON	Cylinder retains current position

4.4 Maximum Piston Rod Speed Setting (Rotary Switch)

The piston rod speed can be set using the rotary switch. The relation between the switch numbers and speed is shown in the table below.

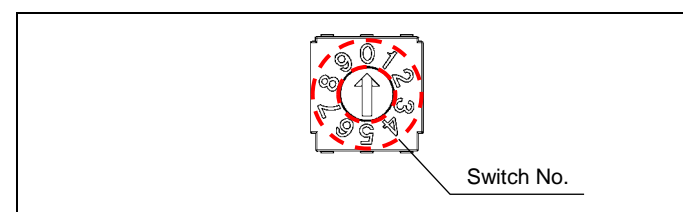

Switch No.	0 (Default)	1	2	3	4	5	6	7	8	9
Slower		→	→	(Gradual Increase in Speed)	→	→				Faster

4.5 Operation

The operation modes for this product include JOG operation, Calibration, Target position operation (4-20mA), No signal operation, and Emergency stop. The functions available during operation are

4 Settings (continued)

residual pressure release and alarm LED display. This section describes each operation mode and function.

4.5.1 JOG Operation

The piston rod moves at a set speed in response to the JOG signal being input. The range of movement is the length of the cylinder stroke. JOG mode is used to stop the piston rod for positioning before calibration or to move the piston rod to a specified position. The speed of movement during the JOG operation is approximately 50 mm/sec (guideline) regardless of the rotary switch speed setting (Refer to section 4.4).

4.5.1.1 Extend Stroke Movement

When the JOG+ signal (Pin No. 3) is ON, the piston rod moves to the extended end. When the JOG- signal (Pin No. 4) turns ON while the JOG+ signal is ON, the piston rod stops and retains the current position. When the JOG+ signal turns OFF during operation, the operation mode will change from the JOG operation to the Target position operation (Refer to section 4.5.3).

JOG+	JOG-	Piston Rod Operation
ON	OFF	Moves to the extended end direction
ON	ON	Stops moving

OFF	OFF	Target position operation (4-20mA)
-----	-----	--

4.5.1.2 Retract Stroke Movement

When the JOG- signal (Pin No. 4) is ON, the piston rod moves to the retracted end. When the JOG+ signal (Pin No. 3) turns ON while the JOG- signal is ON, the JOG operation is stopped, and the piston rod retains the current position. When the JOG- signal turns OFF during operation, the operation mode will change from the JOG operation to the Target position operation (Refer to section 4.5.3).

JOG+	JOG-	Piston Rod Operation
OFF	ON	Moves to the retracted end direction
ON	ON	Stop moving
OFF	OFF	Target position operation (4-20mA)

4 Settings (continued)

4.5.2 Calibration

The piston rod movement range (set point) can be set when using the Target position operation (Refer to section 4.5.3). By performing the calibration, the relationship between the piston rod position (from the retracted end to the set point) and the current value (4-20 mA) input to Sig-in+ and Sig-in- can be set. Once the calibration is performed, the set point is stored in the product and will be recorded even when the power supply is OFF.

- There are two types of calibration mode; Automatic and Manual.
- The set point is not set when the product is shipped from the factory.

Caution

Perform the calibration at the initial installation of the product. Otherwise, the cylinder will not operate even when an analogue signal is input in the target position operation.

4.5.2.1 Change the Mode

Automatic Mode

- **Step 1:** Turn the power supply OFF if it is not already. Ensure that all DIP switches are turned to ON position and check that all LEDs are off.
- **Step 2:** Turn the power supply ON. Ensure that all DIP switches remain in the ON position and check that the LEDs begin to flash at a rate of 1Hz. The product will make an emergency stop and JOG operation, target position operation, no signal operation and calibration are not available.
- **Step 3:** At this stage verify that the LEDs are still flashing at 1Hz; if yes, turn the power supply OFF and check that the LEDs stop flashing. All DIP switches should still be in the ON position.
- **Step 4:** While the power supply is still OFF, refer to sections 4.1, 4.2 and 4.3 and set all DIP switches to the desired positions for the operation required. All LEDs should remain OFF.
- **Step 5:** Turn the power supply ON once all DIP switches have been set to the desired positions and immediately follow step (6).
- **Step 6:** When power supply has been turned ON, all LEDs should flash once. Following this, PWR and CTR lights should remain ON and

CYL, VAL and RF should be OFF. Automatic mode calibration has now been performed and JOG operation, target position operation, and no signal operation are available.

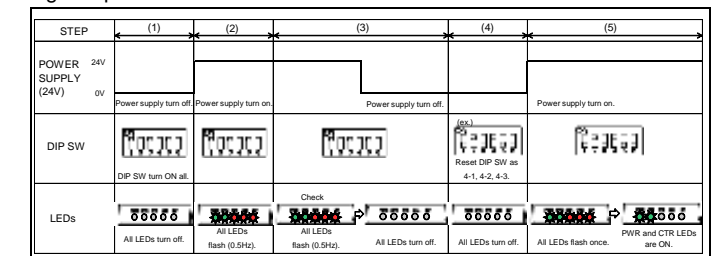

Manual Mode

- **Step 1:** Turn the power supply OFF if it is not already. Ensure that all DIP switches are turned to OFF position and check that all LEDs are off.
- **Step 2:** Turn the power supply ON. Ensure that all DIP switches remain in the OFF position and check that the LEDs begin to flash at a rate of 1Hz. The product will make an emergency stop and JOG operation, target position operation, no signal operation and calibration are not available.
- **Step 3:** At this stage verify that the LEDs are still flashing at 1Hz; if yes, turn the power supply OFF and check that the LEDs stop flashing. All DIP switches should still be in the OFF position.
- **Step 4:** While the power supply is still OFF, refer to sections 4.1, 4.2 and 4.3 and set all DIP switches to the desired positions for the operation required. All LEDs should remain OFF.
- **Step 5:** Turn the power supply ON once all DIP switches have been set to the desired positions and immediately follow step (6).
- **Step 6:** When power supply has been turned ON, all LEDs should flash twice. Following this, PWR and CTR lights should remain ON and CYL, VAL and RF should be OFF. Manual mode calibration has now been performed and JOG operation, target position operation, and no signal operation are now available.

4 Settings (continued)

STEP	(1)	(2)	(3)	(4)	(5)
POWER SUPPLY (24V)	Power supply turn off	Power supply turn on	Power supply turn off	Power supply turn on	Power supply turn on
DIP SW	DIP SW turn OFF all			Reset DIP SW as 4.1, 4.2, 4.3.	
LEDs	All LEDs turn off	All LEDs flash (0.5Hz)	All LEDs flash (0.5Hz)	All LEDs turn off	All LEDs flash twice. PWR and CTR LEDs are ON.

4.5.2.2 Performing Calibration

Automatic Calibration Procedure

While the calibration signal (CAL) is ON the automatic calibration will be performed, and the piston rod will move in the extended end direction. The position at which the piston rod must stop for 1 second, due to an external stopper or cylinder extended end, is set as a set point. When the calibration signal is turned OFF, the operation mode will change to the target position operation. The piston rod speed during auto calibration is approximately 50 mm/sec (guideline).

Manual Calibration Procedure

Perform JOG operation or target position operation (*1) to move the piston rod to the required stop position (example: position where an external stopper is located). When the calibration signal (CAL) is input for 100ms or longer, the position where the piston rod stops is set as a set point. When the setting of the set point is completed, and the calibration signal is turned OFF, the operation mode will change to the target position operation.

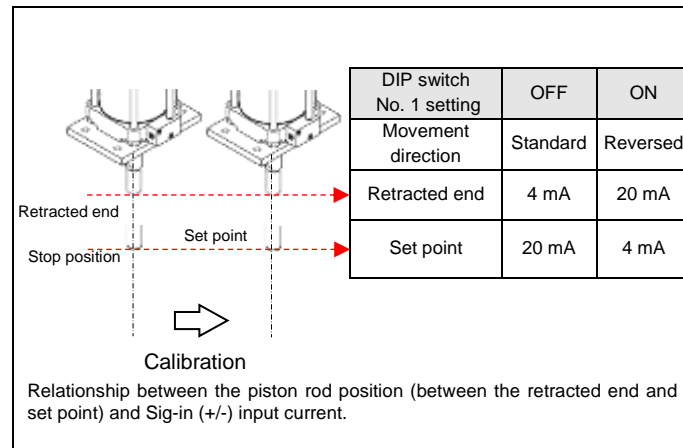

*1 - If calibration is never performed after receiving the product from SMC, the set point is set to the retracted end. Therefore, even if current (4-20mA) is input at the target position operation, the piston stays at the retracted end.

4.5.3 Target Position Operation (4-20 mA)

By inputting an analogue signal, the piston rod moves to the target position which corresponds to the input current (between 4 and 20 mA) from the retracted end to the set point.

4 Settings (continued)

No.1	Movement Direction	Relationship between the analog input signal and the piston rod movement direction	Relationship between the analog input current and the target position
OFF	Standard (Default)	Diagram showing piston rod moving from retracted end to set point (20mA) to target position A (4mA).	Graph showing analog input current (mA) vs target position. Set point is at 20mA, Target position A is at 4mA.
ON	Reversed	Diagram showing piston rod moving from retracted end to set point (4mA) to target position B (20mA).	Graph showing analog input current (mA) vs target position. Set point is at 4mA, Target position B is at 20mA.

4.5.4 No Signal Operation

When an analogue input signal of 3.9 mA or less is input, the piston rod operates according to the No signal operation setting set beforehand. The operation can be selected from 3 types of operation by switching the DIP switch No. 5 and No. 6 (Refer to section 4.3). The speed of movement can be set using the rotary switch.

4.5.5 Emergency Stop

The piston rod will stop operating when the E-STOP signal (pin No. 14) is turned OFF during JOG operation, calibration (automatic mode), target position operation, or No signal operation. When the E-STOP signal is turned ON again, it will return to the previous operation mode.

4.5.6 Residual Pressure Release

The pressure on the head side and rod side of the air cylinder can be released from the residual pressure release valve in the head cover of the product. Rotate the exhaust screw (hexagon socket head cap screw) in the counter clockwise direction to release the valve and

exhaust the air. Exhaust the air only after disconnecting the power supply and air supply. Be cautious of a sudden extension or retraction of the rod during the air exhaust operation. When tightening the air exhaust screw, use a tightening torque of 5.0 to 7.4 Nm.

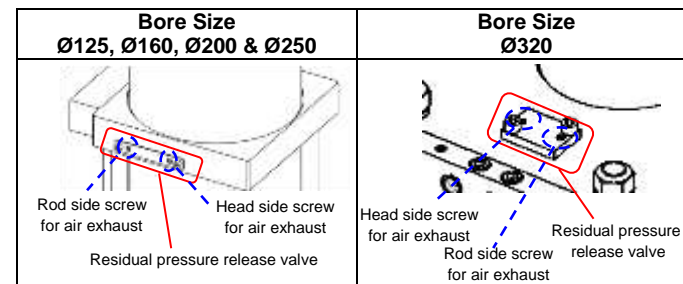

Warning

Take care that a sudden extension or retraction of the piston rod will occur when returning from emergency stop or switching the operation mode.

4.6 LED Alarm Display Function

The names and functions of the LED alarm display are shown in the figure and table below.

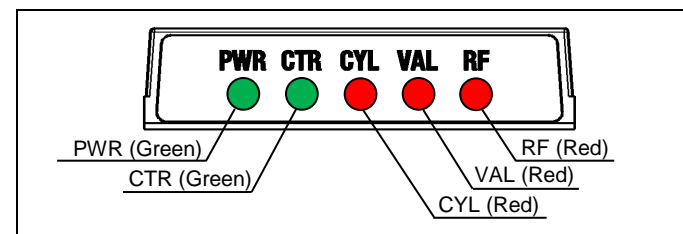

4 Settings (continued)

LED Alarm display	LED name	LED condition	Description (*1)
PWR	Power supply indicator	Green LED is ON	Power supply is ON.
		Green LED flashing (1 Hz)	Power supply error (Outside of 24 V +/- 10%)
		OFF	Power supply is OFF or incorrect power supply (17 V or less)
CTR	Controller indicator	Green LED is ON	Power supply is ON (Normal control)
		Green LED flashing (0.5 Hz)	Incorrect cylinder bore size setting
		Green LED flashing (2 Hz)	Setting the set point in auto calibration mode
CYL	Positioning sensor error indicator	Red LED is ON	Over current to the positioning sensor
		Red LED flashing (1 Hz)	Incorrect positioning sensor
		Red LED flashing (0.5 Hz)	Incorrect positioning sensor connection
VAL	Valve error indicator	Red LED is ON	Over current to the emergency stop valve
		Red LED is ON	Over current to the servo valve
		Red LED flashing (0.5 Hz)	Incorrect servo valve connection
RF	Piston rod worn error indicator	Red LED is ON	Piston rod is worn-out

LED Alarm display	LED condition	Description (*1)
PWR	All LEDs flashing (0.5Hz)	Calibration setting mode (Automatic mode and manual mode)
CTR	All LEDs flashing once (0.5Hz)	Selecting calibration automatic mode (*2)
CYL	All LEDs flashing once (0.5Hz)	Selecting calibration automatic mode (*2)
VAL	All LEDs flashing once (0.5Hz)	Selecting calibration automatic mode (*2)
RF	All LEDs flashing twice (0.5Hz)	Selecting calibration manual mode (*2)

*1: Refer to operation manual (K35-OMW0030 *9. Alarms*) for further details.
*2: Immediately after turning on the power supply in the normal operation mode.

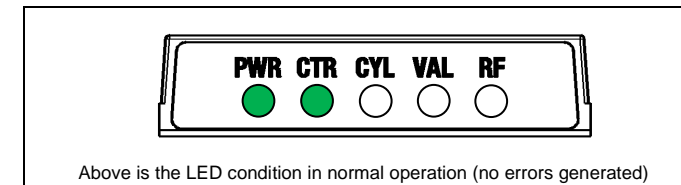

5 How to Order

Refer to customer drawings for 'How to Order'.

6 Outline Dimensions

Refer to customer drawings for outline dimensions.

7 Maintenance

7.1 General maintenance

Caution

- Not following proper maintenance procedures could cause the product to malfunction and lead to equipment damage.
- If handled improperly, compressed air can be dangerous.
- Maintenance of pneumatic systems should be performed only by qualified personnel.

7 Maintenance (continued)

- Before performing maintenance, turn off the power supply and be sure to cut off the supply pressure. Confirm that the air is released to atmosphere.
- After installation and maintenance, apply operating pressure and power to the equipment and perform appropriate functional and leakage tests to make sure the equipment is installed correctly.
- If any electrical connections are disturbed during maintenance, ensure they are reconnected correctly and safety checks are carried out as required to ensure continued compliance with applicable national regulations.
- Do not make any modification to the product.
- Do not disassemble the product, unless required by installation or maintenance instructions.

8 Limitations of Use

8.1 Limited warranty and disclaimer/compliance requirements

Refer to Handling Precautions for SMC Products.

9 Product Disposal

This product shall not be disposed of as municipal waste. Check your local regulations and guidelines to dispose this product correctly, in order to reduce the impact on human health and the environment.

10 Contacts

Refer to www.smcworld.com or www.smc.eu for your local distributor/importer.

SMC Corporation

URL : <https://www.smcworld.com> (Global) <https://www.smc.eu> (Europe)
SMC Corporation, Akihabara UDX15F, 4-14-1, Sotokanda, Chiyoda-ku, Tokyo 101 0021
Specifications are subject to change without prior notice from the manufacturer.
© 2020 SMC Corporation All Rights Reserved.
Template DKP50047-F-085L