



ORIGINAL INSTRUCTIONS

Instruction Manual Ionizer - Nozzle type IZN10E Series



The intended use of this product is to neutralize charged objects.

1 Safety Instructions

These safety instructions are intended to prevent hazardous situations and/or equipment damage. These instructions indicate the level of potential hazard with the labels of "Caution," "Warning" or "Danger."

They are all important notes for safety and must be followed in addition to International Standards (ISO/IEC)⁽¹⁾, and other safety regulations.

⁽¹⁾ ISO 4414: Pneumatic fluid power - General rules relating to systems.

ISO 4413: Hydraulic fluid power - General rules relating to systems.

IEC 60204-1: Safety of machinery - Electrical equipment of machines. (Part 1: General requirements)

ISO 10218-1: Robots and robotic devices - Safety requirements for industrial robots - Part 1: Robots.

- Refer to product catalogue, Operation Manual and Handling Precautions for SMC Products for additional information.
- Keep this manual in a safe place for future reference.

	Caution	Indicates a hazard with a low level of risk, which if not avoided, could result in minor or moderate injury.
	Warning	Indicates a hazard with a medium level of risk, which if not avoided, could result in death or serious injury.
	Danger	Indicates a hazard with a high level of risk, which if not avoided, will result in death or serious injury.

Warning

- Always ensure compliance with relevant safety laws and standards.
- All work must be carried out in a safe manner by a qualified person in compliance with applicable national regulations.

Caution

- Ensure that the air supply system is filtered to 5 microns.

2 Specifications

2.1 Ionizer Specifications

Model	IZN10E-#	IZN10E-#P	
Ion generation method	Corona discharge		
Method of applying voltage	High frequency AC type		
Applied voltage	±2.5 kVAC		
Offset voltage	Energy saving nozzle: ±10 V High flow rate nozzle: ±15 V		
Air purge	Fluid	Air (clean dry air)	
	Operating pressure	0.05 to 0.7 MPa	
	Tube O.D.	Ø6 mm, ø1/4 inch	
Power supply voltage	24 VDC ±10%		
Current consumption	80 mA or less		
Input signals	Voltage	Connected to 0 V. 5 VDC max.	Connected to +24 V 19 to 24 VDC
	Current consumption	5 mA max.	
Output signals	Load current	40 mA max.	
	Residual voltage	1 V or less	
	Applied voltage	26.4 VDC max.	-
Effective Static neutralization distance	20 to 500 mm		
Ambient temperature	0 to 55°C (no freezing)		
Ambient humidity	35 to 65%RH (no condensation)		

3 Installation

3.1 Installation

Warning

- Do not install the product unless the safety instructions have been read and understood.
- Provide adequate space for maintenance, piping and wiring.** Install the product with consideration for connector mounting, emitter cartridge removal / assembly for cleaning of the emitter, and the one-touch fitting for supplying compressed air, so that there is enough space for mounting and removal of the power cable, cartridge assembly and air tubing and for emitter maintenance, inspection and wiring. To avoid applying unreasonable stress on the connector and one-touch fitting, ensure any bends in the cable or air tubing are greater than the minimum bending radius. If the cable or air tubing is bent at an acute angle or repeated load is applied to the cable, it may cause malfunction, wire damage or fire.
- Mount the product on a flat surface.** Mounting on an uneven surface will apply excessive force to the frame or case, which may lead to damage or failure. Do not drop or apply excessive shock. Otherwise, damage or an accident may occur.
- Keep the area specified clear when the product is mounted directly on to a base or workpiece which is connected to ground.** Mount the product with the base to the work piece avoiding the area (shaded) in the drawing below. If the grounded base or workpiece is too close to the area (shaded), ozone concentration may increase depending on the operating conditions, causing failure of the product.

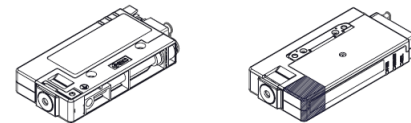

Note) Refer to dimensions for dimensions of the area (shaded).

- Avoid using in a place where noise (electromagnetic wave and surge) is generated.** If the product is used in an environment where noise is generated, it may lead to deterioration or damage of the internal elements. Take measures to prevent noise at its source and avoid power and signal lines from coming into close contact.
- Use the correct tightening torque.** If the screws are tightened in excess of the specified torque range, it may damage the mounting screws, mounting brackets, etc. If the tightening torque is insufficient, the mounting screws and brackets may become loose.
- Do not allow foreign matter or a tool to enter the ionizer nozzle.** The emitter is installed in the nozzle. If a conductive object such as metal tools or the human body either contacts or comes close to the emitter, reaction to electric shock can lead to further injuries due to collision with surrounding equipment. Also, if the tool damages the emitter, it may interfere with the specified function and performance, and may also cause operation failure or an accident.

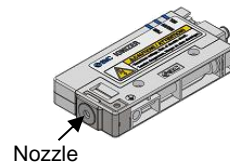

Nozzle

Caution: High Voltage

High voltage is applied to the emitter. Never touch the electrodes. Inserting foreign matter into the cartridge or touching the electrode may cause electrical shock and instantaneous rapid body motion to escape from the shock. Your body may then impact the equipment around you, causing injury.

- Avoid applying a moment force to the nozzle.** A moment may be applied to the nozzle depending on the shape or length of the nozzle mounted to the female threads for piping. It is possible that the nozzle or body will be damaged. If a moment force of more than 0.05 Nm is applied, the middle of the nozzle should be supported so that the nozzle does not receive the moment.

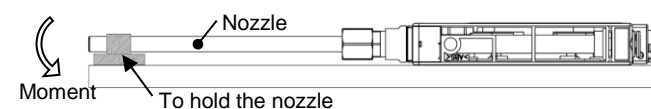

- Do not adhere tape or labels onto the product body.** If the tape or label contains conductive adhesive or reflective paint, it is possible that due to the dielectric effect, a charge could build up causing an electro-static discharge or electrical leakage.

3 Installation (continued)

- Ensure that both the power supply and compressed air supply are disconnected before commencing with the product installation.

Caution

- Make sure to confirm the effect of static neutralization after installation.** The effect of the static neutralization varies depending on the surrounding installation and operating conditions. Confirm the effect of the static neutralization after installation.

3.1.1 Precautions for Installation

Ensure that both the power supply and compressed air supply are disconnected before commencing with the product installation. Do not affix any tape or labels to the product. If the tape or label contains any conductive adhesive or reflective paint, a dielectric phenomenon may occur due to ions arising from such substances, resulting in electrostatic charging or electric leakage. Keep sufficient space so that the cartridge assembly can be removed for cleaning and replacement of the emitter. For cleaning or replacing the emitter, as shown in drawing step 1 to 3 below, remove the power cable and release the cartridge assembly lock by rotating the locking knob to the FREE position. Then, pull the cartridge assembly in the direction of the arrow. Do not touch the emitter when removing the cartridge assembly. (The locking knob cannot be rotated until the power cable is removed).

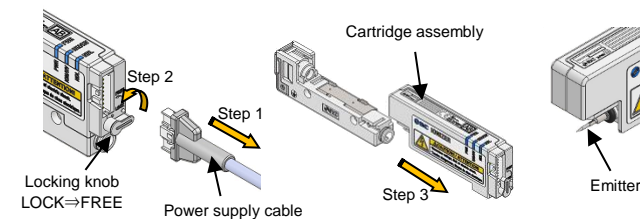

The procedure for mounting the cartridge assembly is the reverse of removal. Confirm that the Locking knob is in the FREE position. The cartridge assembly cannot be inserted while the locking knob is in the LOCK position, attempting to do so may cause damage.

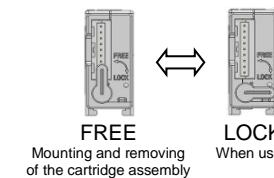

3.1.2 Ionizer Body Installation

1) Installation of the energy saving nozzle

The energy saving nozzle uses external air via the external air inlet. The external air inlets are located in part A and B (shown below). When an energy saving nozzle is used, do not cover the external air inlets. If the external air flow is blocked, product performance will decrease.

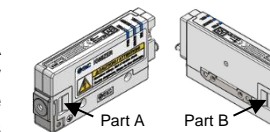

2) Installation without bracket

If a bracket is not used, install the product using either the through holes or tapped holes. When installing the product, use M3 hexagon socket head cap screws. (The screws should be prepared by the user). Referring to the figure below, affix the product using screws of optimum length. M3 screw recommended tightening torque is 0.61 to 0.63 Nm.

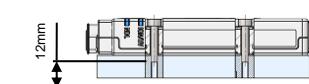

Use a screw with a length of more than 12 mm.

Top through-hole mounting

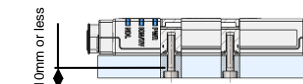

Use a screw with maximum screw-in depth of 10 mm

Bottom tapped-hole mounting

3 Installation (continued)

3) Installation with bracket

There are 3 types of bracket available (L- bracket, Pivoting bracket, and DIN rail mounting bracket).

(1) L- bracket

The L- bracket can be mounted in 4 different ways as shown below.

	Outward mounting	Inward mounting
Pivot mounting		
Fixed mounting		

The bracket mounting methods are shown below.

a. Mounting the product to the bracket

If angle adjustment is required after fixing the product, use the elongated holes in the bracket. If this is not required use the round holes.

For mounting the product to the bracket, use the hexagon socket head cap screws (M3 x 6) and flat washers included with the bracket. Refer to "Dimensions" section for details.

Tightening torque: 0.61 to 0.63 Nm.

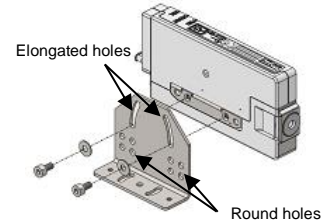

b. Mounting of the bracket

For mounting the bracket to an installation etc., use either the through holes or tapped (M3) holes and use the elongated or round holes in the base of the bracket. When angle adjustment is necessary after installation, use the elongated holes.

If the elongated holes are used, the flat washers included with the bracket must be used.

The mounting screws should be prepared by the user. Refer to "Dimensions" section for details.

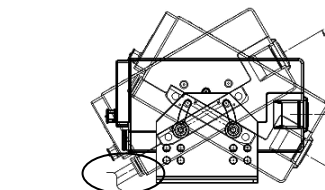
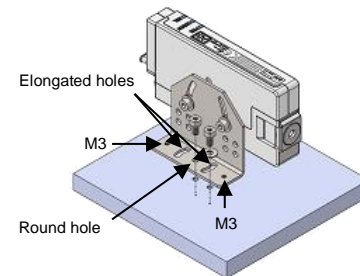

Avoid interfering with piping.

Mounting angle adjustable range of the L-bracket

(2) Pivoting bracket

a. Mounting of the product to the bracket.

For mounting the product to the bracket, use the hexagon socket head cap screws (M3 x 16) included with the bracket.

Tightening torque: 0.61 to 0.63 Nm

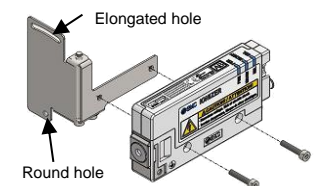

3 Installation (continued)

b. Fixing of the bracket

For mounting the bracket to an installation etc., use the elongated holes or round holes.

If the elongated holes are used, the flat washers included with the bracket must be used.

The mounting screws should be prepared by the user. Refer to "Dimensions" section for details.

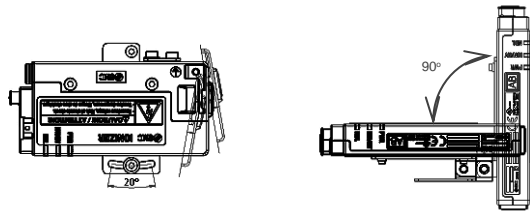

Mounting angle adjustable range of the pivoting bracket

(3) DIN rail mounting bracket

a. Angle adjustment of the DIN rail mounting bracket.

The DIN rail mounting bracket angle is adjustable.

Tighten the threads A after adjusting the angle.

Tightening torque: 0.61 to 0.63 Nm

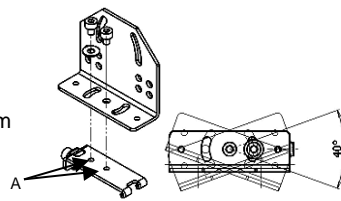

b. Mounting of the product to the bracket.

If angle adjustment is required after fixing the product, use the elongated holes in the bracket. If this is not required use the round holes.

For mounting the product to the bracket, mount the L-bracket using the hexagon socket head cap screws (M3 x 6) and flat washers included with the bracket.

Refer to "Dimensions" section for details.

Tightening torque: 0.61 to 0.63 Nm.

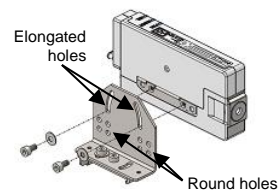

c. Fixing to the DIN rail.

Place the DIN rail in the groove B and tighten the hexagon socket head cap screw.

Tightening torque: 0.61 to 0.63 Nm.

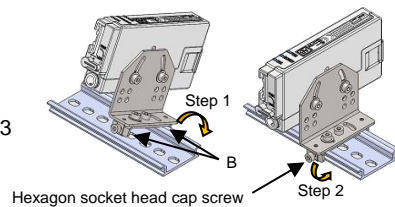

4) Manifold mounting

The spacers packed together with the parts set must be used for assembly. Their purpose is to create a common ground connection.

Refer to the drawing below for assembling (when 3pcs. are connected).

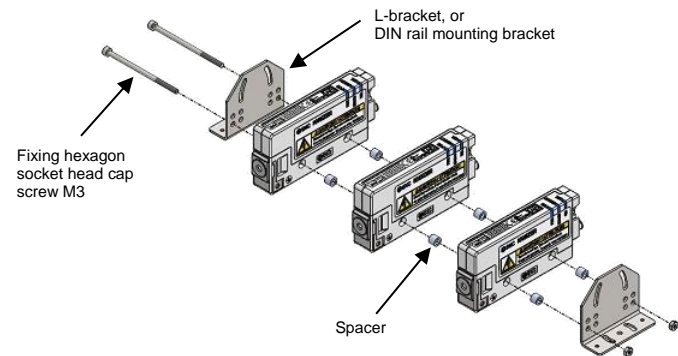

3 Installation (continued)

3.2 Environment



Warning

- Do not use in an environment where corrosive gases, chemicals, salt water or steam are present.
- Do not use in an explosive atmosphere.
- Do not expose to direct sunlight. Use a suitable protective cover.
- Do not install in a location subject to vibration or impact. Check the product specifications.
- Do not mount in a location exposed to radiant heat.
- Observe the fluid temperature and ambient temperature range.** The operating fluid temperature range is 0 to 55°C. The specified ambient temperature range for the Ionizer is 0 to 55°C, and for the AC adapter is 0 to 40°C. Avoid sudden temperature change even within the specified ambient temperature range, as it may cause condensation.

Do not use this product in an enclosed space.

This product utilizes the corona discharge phenomenon. Do not use the product in an enclosed space as ozone and nitrogen oxides exist, even though in marginal quantities.

Take prevention measures against ozone.

Check that all surrounding equipment have ozone protection measures in place. Perform periodic checks of the product for deterioration caused by ozone.

Supply compressed air when the product is in use.

If compressed air is not supplied, neutralization is not possible and ozone and NOx produced during ion generation may accumulate, causing adverse effects on the inner parts or peripheral devices. Compressed air must always be supplied during discharging.

When the product is used for intermittent ion blow, pressure fluctuations can cause instability in the corona discharge, resulting in difficulty maintaining the offset voltage specification. Ensure there are no problems with the neutralization performance when the product is used for intermittent ion blow.

Environments to avoid

Avoid using and storing this product in the following environments since they may cause damage to the product. These may cause an electric shock, fire, etc.

- Areas where ambient temperature exceeds the operating temperature range.
- Areas where ambient humidity exceeds the operating humidity range.
- Areas where abrupt temperature changes may cause condensation.
- Areas where corrosive gas, flammable gas or other volatile flammable substances are stored.
- Areas where the product may be exposed to conductive powder such as iron powder or dust, oil mist, salt, organic solvent, machining chips, particles or cutting oil (including water and any liquids), etc.
- Paths of direct air flow, such as air conditioners.
- Enclosed or poorly ventilated areas.
- Locations which are exposed to direct sunlight or heat radiation.
- Areas where strong electromagnetic noise is generated, such as strong electrical and magnetic fields or supply voltage spikes.
- Areas where the product is exposed to static electricity discharge.
- Locations where strong high frequency is generated.
- Locations which are subject to potential lightning strikes.
- In an area where the product may receive direct impact or vibration.
- Areas where the product may be subjected to forces or weight that could cause physical deformation.

Do not use air containing mist and/or dust.

Air containing mist or dust will cause the performance to decrease and shorten the maintenance cycle.

Install a dryer (IDF series), air filter (AF/AFF series), or mist separator (AFM/AM series) to obtain clean compressed air (air quality of Class 2.6.3 or higher according to ISO 8573-1: 2001 is recommended for operation).

- The product does not incorporate a protection to lightning surges.

3.3 Piping

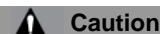

Caution

- Before piping make sure to clean up chips, cutting oil, dust etc.
- When installing piping or fittings, ensure sealant material does not enter inside the port. When using seal tape, leave 1.5 to 2 threads exposed on the end of the pipe/fitting.
- Tighten fittings to the specified tightening torque.

3 Installation (continued)

3.4 Wiring



Warning

- Before wiring, ensure that the power supply capacity meets the specification and that the voltage is within the specification.**
- To maintain product performance, the power supply should be UL Class 2 certified by National Electric Code (NEC) or evaluated as a limited power source according to UL60950.**
- To maintain the product performance, ground the product with an earth ground cable with a resistance of 100 Ω or less according to this manual.**
- Remove the power supply before wiring (including the connector plug in/out).**
- Ensure the safety of wiring and surrounding conditions before supplying power.**
- Do not connect or disconnect the connectors (including power source) while the power is supplied. Failure to follow this procedure may cause product malfunction.**
- Malfunctions stemming from noise may occur if the wire is installed in the same route as that of power or high-voltage cable. Route the lonizer wires separately.**
- Confirm that the wiring is correct before operation. Incorrect wiring will lead to product damage or malfunction.**

3.4.1 Connection Circuit

Wire power cables according to the connection circuit and wiring diagram. Make sure to ground the ground terminal with a resistance of 100 Ω or less.

The ground terminal is used as a reference electric potential for static neutralization. If the ground terminal is not grounded correctly, the lonizer will not be able to achieve the optimal offset voltage (ion balance).

Connection circuit

NPN Input / Output

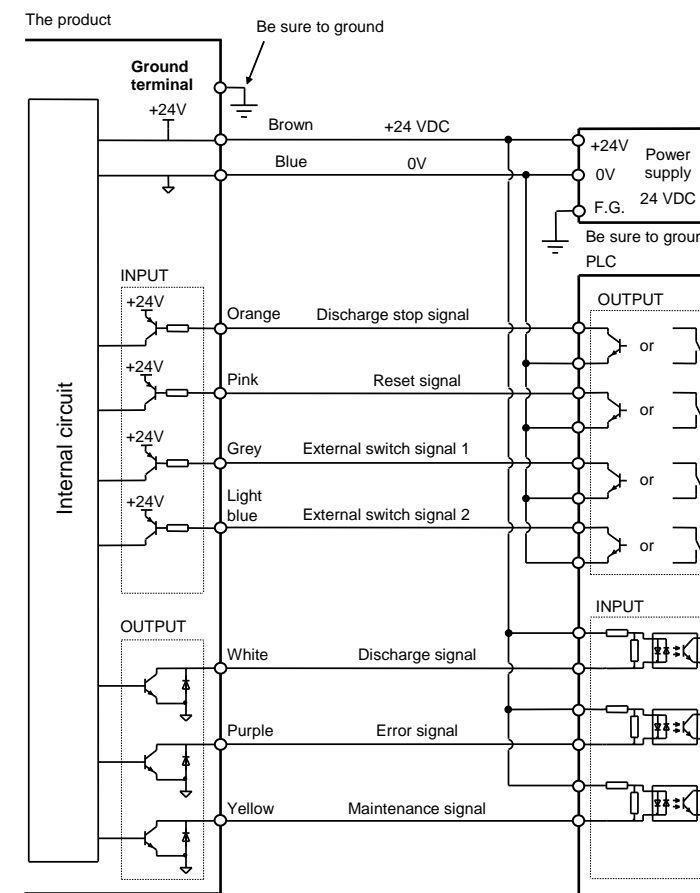

3 Installation (continued)

PNP Input / Output

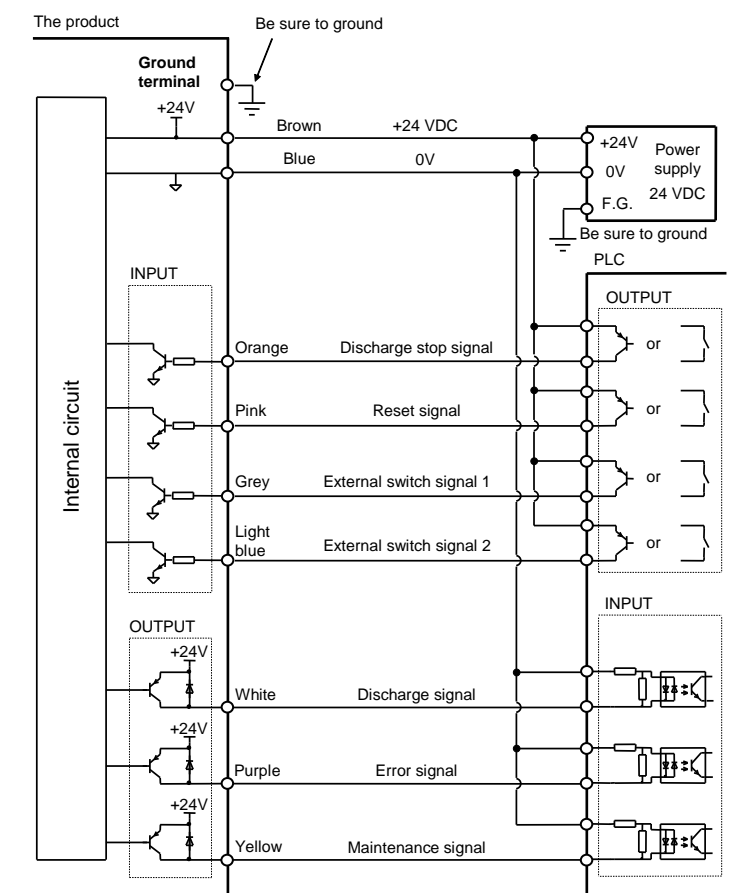

3.4.2 Wiring of the power supply cable

Install the cables with more than the minimum bending radius to prevent an excessive stress from being applied to the cables and/or connectors.

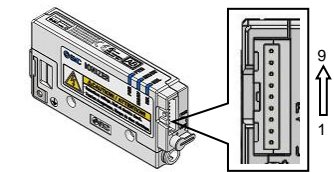

Minimum bending radius: 30 (mm)

Note) This is an allowable bend radius at 20°C. When the cables are bent at a lower temperature than 20°C, it may cause unreasonable force to be applied to the connectors.

Unused electric wires should be cut short or insulated to avoid contacting with other electric wires.

Wiring

Pin No.	Cable colour	Signal name	I/O	Description
1	Brown	+24 VDC	IN	Power supply connection to operate the product.
2	Blue	0V	IN	
3	Orange	Discharge stop signal	IN	Signal input to turn ON/OFF the ion discharge. NPN: Starts ion discharge by connecting to 0 V. (Stops discharging ion when disconnected). PNP: Starts ion discharge by connecting to +24 VDC. (Stops discharging ion when disconnected).
4	Pink	Reset signal	IN	Input signal to clear error signal. (If the source of error is not eliminated, an error signal will be output again after inputting the reset signal)
5	White	Discharge signal	OUT (Albeit contact)	The signal is ON while the product is discharging.
6	Purple	Error signal	OUT (Break contact)	The signal is OFF when the power supply, high voltage or CPU is abnormal. (The signal is ON green when there is no problem.)
7	Yellow	Maintenance signal	OUT (Albeit contact)	The signal is ON when the neutralizing performance has decreased.
8	Grey	External switch signal 1	IN	Product can be turned ON/OFF by connecting an external switch. NPN: Connect the switch between 0 V and the external switch signal. Electric discharge stops when the connected switch is ON.
9	Light blue	External switch signal 2	IN	PNP: Connect the switch between +24 VDC and the external switch signal. Electric discharge stops when the connected switch is ON.

3 Installation (continued)

3.4.3 Ground connection

Make sure to ground the ground terminal with a resistance of 100 Ω or less.
The ground terminal is used as a reference electric potential for static neutralization. If the ground terminal is not grounded correctly, the ionizer will not be able to achieve the optimal offset voltage (ion balance).

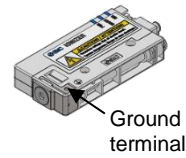

3.4.4 AC adapter

Select the same input/output specification as the product.
If the product input/output specification and AC adapter input/output specification are different, the product will not operate.

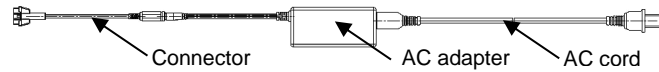

3.5 Function

3.5.1 Name of Parts

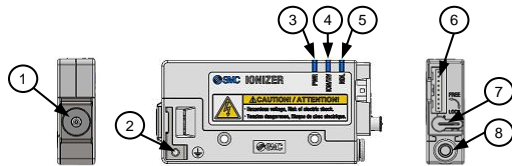

NO.	Description	Symbol	Type	Description
1	Nozzle	-	-	Discharges ionized air
2	Ground terminal	⊥	Terminal	Reference point for neutralization. Connect to Ground with 100 Ω or less.
3	Power supply indicator	PWR	LED (Green)	LED is ON when the power supply is ON; LED flashes when the power supply or CPU is abnormal.
4	Ion discharge / Incorrect high voltage LED	ION/HV	LED (Green / Red)	Green LED is ON: discharge in progress Green LED flashing: Overcurrent at output Red LED is ON: high voltage error Red LED flashing: CPU error
5	Emitter maintenance indicator	NDL	LED (Green)	LED is ON: ion generation decreased LED flashing: CPU error
6	Connector	-	Connector	Connector for power supply and input/output signals.
7	Locking knob	-	Knob	Knob for locking the cartridge assembly. Power cable can be mounted/removed only when the Knob is in the LOCK position.
8	Piping port	-	One-touch Fitting	Port for compressed air supply.

3.5.2 Alarm function

If abnormal functioning occurs during operation, the user will be alerted by the external output signal or LED operation.

Alarm name	Status of the parallel I/O signals	ON LED	LED blinking (Hz)	Operation after alarm + ions are generated	Product	How to release error after recovery
Power supply failure	Error signal OFF (Break contact) Discharge signal OFF (Albeit contact) Maintenance signal OFF (Albeit contact)	-	PWR (Green)	Stop	When the connected power supply voltage is outside of the specification.	Auto
Incorrect high voltage	Error signal OFF (Break contact) Discharge signal OFF (Albeit contact) Maintenance signal OFF (Albeit contact)	ION/HV (Red)	-	Stop	When abnormal high voltage is discharged.	Reset signal input. Turn the power on again.
Output signal over current	-	-	ION/HV (Green)	Continue	Over current is present on the output circuit and protection circuit is activated.	Auto
CPU ALM	Error signal OFF (Break contact) Discharge signal OFF (Albeit contact) Maintenance signal OFF (Albeit contact)	-	PWR (green) ION/HV (red) NDL (green)	Stop	When CPU operates abnormally due to noise etc.	Turn the power on again.
Maintenance warning	Maintenance signal ON (Albeit contact)	NDL (Green)	-	Continue	When static neutralization performance is reduced due to contamination, wearing or breakage of the emitter.	Input ion discharge signal. Turn off the power and then on again.

1) Power supply failure

If the power supply connected to the product is not within the range of 24 V +/-10%, the error signal will be turned OFF (ON when it is normal), the discharge signal will be turned OFF, and the PWR LED (green) will flash to indicate the error.
When failure occurs, ion generation will be stopped.
To resolve the error, reset the product automatically by connecting a power supply which provides a power supply voltage of 24 V +/-10%.

3 Installation (continued)

2) Incorrect high voltage

If incorrect the emitter discharge is detected during operation, the error signal will be turned OFF (ON when it is normal), the discharge signal will be turned OFF, and the ION/HV LED (red) will be ON to indicate the error.
When failure occurs, ion generation will be stopped.
Incorrect electric discharge could be caused by condensation or dust on the emitter.
To resolve the error, input the reset signal or supply power again after remedying the cause of the incorrect electric discharge.

3) Output signal over current

If excessive current flows to the output circuit, the current will be limited to protect the circuit and the ION/HV LED (green) will flash to indicate the error.
The product operates even when excessive current is generated in the output circuit.
To resolve the error, reset the product automatically by reducing the current to the output circuit down to 40 mA or less.

4) CPU error

If the CPU makes an abnormal operation due to noise or other reasons, the error signal will be turned OFF (ON when it is normal), and the PWR LED (green), ION-HV LED (red) and NDL LED (green) will flash to indicate the error.
When failure occurs, ion generation is stopped.
To prevent noise, perform the following actions and take countermeasures.
1. Keep the product away from sources of noise.
2. Route the power line and cable of the product separately.
3. Install a noise filter to the power supply of the product.
To resolve the error, supply power again after fixing the cause of the error.

5) Maintenance warning

The maintenance signal is ON when static electricity neutralization performance has decreased due to contamination, wear or damage to the emitter. The NDL LED (green) will turn ON to indicate that cleaning or replacement of the emitter is required.
The product continues to operate even when the maintenance warning has been generated.
When the emitter is contaminated, the error can be solved by cleaning it. However, when they are worn out or damaged, it is necessary to replace the emitter assembly.
To resolve the error, input the discharge stop signal or supply power again after remedying the cause of the error.
When the female threads for piping option is used, the maintenance signal will turn ON if the nozzle pressure increases (causing the ion generation to decrease) due to the nozzle type.

• Cautions when using the IZN10E-11□□□□ (Female threads for piping)

For the female threads (Rc1/8), either a Made-to-Order nozzle or a fitting/tubing combination must be prepared and connected by the user. If a nozzle with an outlet port or I.D. of less than 4 mm is connected, the air pressure in the nozzle may increase, depending on the configuration. The product uses a high frequency AC voltage. If the air pressure at the emitter increases during ion generation, the efficiency decreases and the maintenance alarm (signal output, maintenance LED) will be activated (refer to the figure).
Neutralizing performance is low when the maintenance alarm is generated.

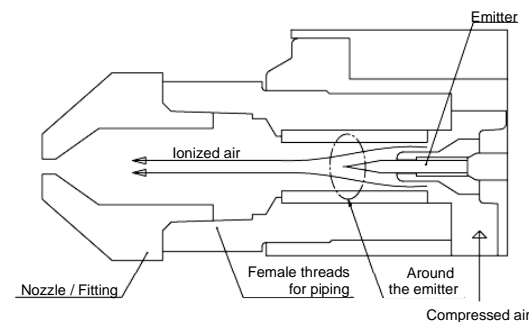

Female threads for piping (cross section)

4 How to Order

Refer to the operation manual or catalogue on the SMC website (URL: <https://www.smcworld.com>) for "How to Order" information

5 Outline Dimensions (mm)

Refer to the operation manual or catalogue on the SMC website (URL: <https://www.smcworld.com>) for "Outline dimensions."

6 Maintenance

6.1 General Maintenance

Warning

• Perform maintenance regularly and clean the emitter.

Periodically inspect the electrostatic sensor to check if it is operated under faulty conditions. Maintenance must be carried out by an operator who has sufficient knowledge and experience.
The emitter must be cleaned when the maintenance display (NDL) LED is ON.
If the product is used for an extended period of time with dust present on the emitter, the product's ability to eliminate static electricity will be reduced. The energy saving nozzle is more susceptible to the environment than either the high flow rate nozzle or the female threads for piping because it uses the surrounding air; dust will collect on the emitter more easily.
If the emitter becomes worn and the product's ability to eliminate static electricity is not restored after cleaning, replace the emitter assembly.

Caution: High Voltage

This product contains a high voltage generation circuit. When performing maintenance inspection, be sure to confirm that the power supply to the ionizer is turned off. Never disassemble or modify the product, as this can cause loss of product functionality, and there is also a risk of electric shock and earth leakage.

• The air tube and fitting must be handled as a consumable part.

The tube and fitting connected to the female threads for piping can deteriorate due to ozone and need to be replaced regularly, or alternatively provide protection against ozone.

• Cleaning or replacing the emitter should never be performed while the power supply and compressed air supply are ON.

If the emitter is touched while the product is energized, this may cause an electric shock or accident.
If the cartridge assembly is removed while compressed air is supplied, the cartridge assembly will shoot out. If cartridges are not securely mounted to the bar, they may eject or release when compressed air is supplied to the product.

• After installation and maintenance, apply operating pressure and power to the equipment and perform appropriate functional and leakage tests to make sure the equipment is installed correctly.

• Do not disassemble or modify the product.

Disassembling or modifying the product may cause product failure, electric shock or fire. The product will not be guaranteed if it is disassembled and/or modified.

• Do not operate the product with wet hands.

Never operate the product with wet hands. It may cause electric shock or other accidents.

Caution

• Do not drop, hit or apply excessive shock (100m/s² or more) to the product during handling.

The inner parts may be damaged leading to malfunction even if there is no visible external damage.

• Take care during mounting and removal of the connector.

When the power cable is connected or disconnected, pinch the connector claw together and insert or remove the plug directly in line. If connected or disconnected in an inappropriate direction, the connector may be damaged and cause operation failure.

6 Maintenance (continued)

6.2 Emitter maintenance alarm and cleaning

If the ionizer is used for an extended period of time, contamination such as dust will stick to the emitter, reducing the static neutralization performance.
This product has a function which continuously monitors the discharge from the emitter. If the neutralization performance decreases due to contamination, it is indicated by the maintenance signal and LED.
It is recommended to clean the emitter when the maintenance alarm is generated, or every two weeks.
(The cleaning frequency varies depending on the environment where the ionizer is installed.)
If the ionizer performance does not recover after cleaning the emitter, it can be assumed that the emitter is damaged or worn. If wear or damage of the emitter is detected, replace the emitter assembly.
Clean the emitter using the cleaning kit [IZS30-M2] or a cotton bud soaked in alcohol.
Cleaning of the emitter should never be performed with the power supply and compressed air supplied to the product.
In addition, if the emitter is touched while the product is energized, it may cause electric shock or an accident. As the emitter end is sharp, be careful not to touch it. Otherwise, it may cause injury.

- Mounting/Removal of the cartridge assembly and cleaning of the emitter -

1. Ensure that the power supply and compressed air supply are disconnected before removing the power cable.
2. Turn the locking knob of the cartridge assembly to the FREE position to release the lock.
(The locking knob cannot be operated until the power cable is removed).
3. The cartridge assembly can be removed by pulling it in the direction of the arrow. Take care with the emitter when removing the cartridge assembly.

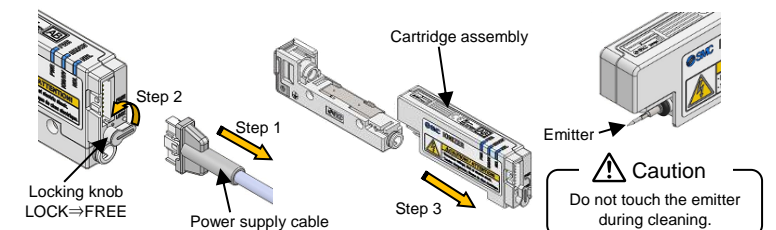

4. Clean the emitter mounted to the cartridge assembly.



- Cleaning of the emitter -

Using the cleaning kit, saturate the felt with industrial alcohol, insert it into the emitter and rotate several times to clean. If the dirt does not come off, use the rubber grindstone to clean the emitter in the same way. After that, again use the felt saturated with industrial alcohol to finish the cleaning.
If a cleaning kit is not available, saturate a cotton swab with alcohol (Note 1) to clean the emitter.

Note 1) The industrial alcohol used should be reagent ethanol class 1 99.5 vol% or greater.

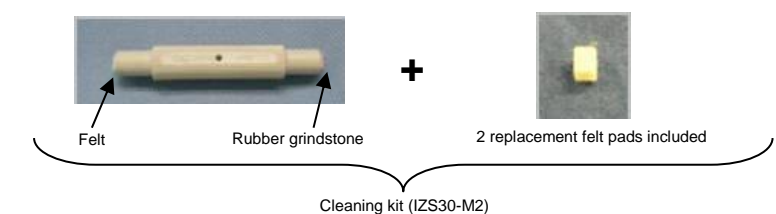

Cleaning kit (IZS30-M2)

6 Maintenance (continued)

The cleaning kit has a felt pad and a rubber grindstone. Choose the felt pad or rubber grindstone depending on the level of contamination to effectively clean the emitter.

Felt: Use for normal cleaning.

Rubber grindstone: Use if dirt is hard and stuck to the emitter and it is not possible to remove with felt.

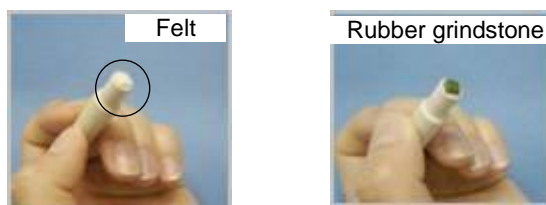

5. The procedure for mounting the cartridge assembly is the reverse of removal. Confirm that the locking knob is in the FREE position. The cartridge assembly cannot be inserted while the locking knob is in the LOCK position, attempting to do so may cause damage.

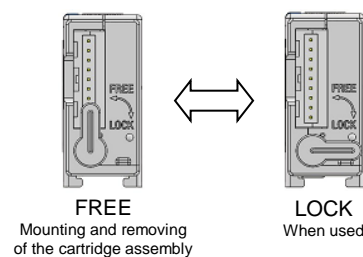

6.3 Replacement of the emitter assembly

If the emitter is worn out or damaged, replace the emitter assembly.

- Mounting/Removal of the cartridge assembly and replacement of the emitter -

1. Ensure that the power supply and compressed air supply are disconnected before removing the power cable.
2. Turn the locking knob of the cartridge assembly to the FREE position to release the lock.
(The locking knob cannot be rotated until the power cable is removed).
3. The cartridge assembly can be removed by pulling it in the direction of the arrow. Take care with the emitter when pulling the cartridge assembly.

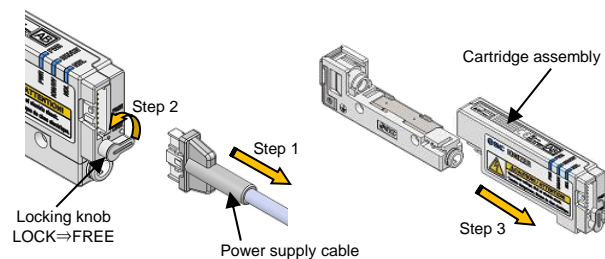

4. Hold the emitter assembly (which is mounted to the cartridge assembly) using tweezers and pull out in the direction of the arrow. To avoid injury take care not to touch the very sharp emitter end.

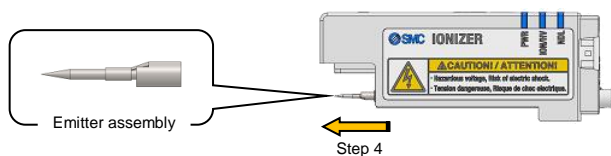

5. When mounting a new emitter assembly to the cartridge assembly, use gloves and tweezers to ensure the emitter is not contaminated. (Do not touch the emitter assembly with bare hands).
6. The procedure for mounting the cartridge assembly is the reverse of removal.

7 Limitations of Use

Warning

Do not exceed any of the specifications laid out in section 7 of the operation manual or the product catalogue.

8 Product disposal

This product should not be disposed of as municipal waste. Check your local regulations and guidelines to dispose of this product correctly, in order to reduce the impact on human health and the environment.

9 Contacts

Refer to www.smcworld.com or www.smc.eu for your local distributor / importer.

SMC Corporation

URL : <http://www.smcworld.com> (Global) <http://www.smc.eu> (Europe)
SMC Corporation, 4-14-1, Sotokanda, Chiyoda-ku, Tokyo 101-0021, Japan
Specifications are subject to change without prior notice from the manufacturer.
© 2021 SMC Corporation All Rights Reserved.
Template DKP50047-F-085M